



| | | | | |
|----|--|---|--|---|
| 6 | Slim LED Panel Ofis Armatürleri |  |  |  |
| 8 | Sıva Altı Backlight Ofis Armatürleri |  |  |  |
| 10 | Sıva Altı & Üstü Backlight Ofis Armatürleri |  |  |  |
| 11 | Sıva Üstü Backlight Ofis Armatürleri |  |  | |
| 12 | Sıva Altı & Üstü Ofis Armatürleri |  |  |  |
| 13 | Steril Ortam ve Hastane Armatürleri |  |  |  |
| 14 | Sıva Altı Mimari Ofis Armatürleri |  |  |  |
| 15 | Mimari Sarkıt & Sıva Üstü Armatürler |  |  |  |
| 16 | Lineer Armatürler |  |  |  |
| 18 | Dekoratif Sarkıt Armatürler |  |  |  |
| 20 | Sıva Altı Slim LED Downlight Armatürler |  |  |  |
| 21 | Sıva Üstü Slim LED Downlight Armatürler |  |  | |
| 22 | Sıva Altı Backlight LED Downlight Armatürler |  |  |  |

| | | | | |
|----|--------------------------------|--|--|---|
| 24 | LED Spot Armatürler |  |  |  |
| 25 | LED Ray Spotlar |  |  |  |
| 26 | LED Tavan Armatürleri |  |  |  |
| 28 | IP44 Tavan & Duvar Armatürleri |  |  |  |
| 29 | IP66 Tavan Armatürleri |  |  |  |
| 30 | Sensörler |  |  |  |
| 32 | Sensörlü Armatürler |  |  |  |
| 33 | Bant Armatürler |  | | |
| 36 | Etanj Armatürler |  | | |
| 38 | Acil Aydınlatma Armatürleri |  |  |  |
| 40 | Acil Yönlendirme Armatürleri |  |  |  |
| 42 | Okul Armatürleri |  | | |
| 43 | Atölye Armatürleri |  |  |  |

| | | | | |
|----|---|---|--|---|
| 44 | Yüksek Tavan Armatürleri |  |  |  |
| 46 | Benzinlik Armatürleri |  |  | |
| 47 | Ex-Proof Armatürler |  |  |  |
| 48 | LED Projektörler |  |  |  |
| 52 | Projektörler |  |  |  |
| 53 | Wallwasherlar |  |  | |
| 54 | LEDli Yol Aydınlatma Armatürleri |  |  |  |
| 56 | Yol Aydınlatma Armatürleri |  |  |  |
| 59 | LEDli Park Bahçe Aydınlatma Armatürleri |  |  |  |
| 64 | LEDli Park Bahçe Aydınlatma Armatürleri | |  |  |
| 65 | Takım Park Bahçe Armatürleri |  |  |  |
| 68 | Çimen Armatürleri | |  |  |
| 69 | Aplik & Set Üstü Armatürler |  |  |  |

| 70 | Duvar Gömme ve Havuz Armatürleri |  |  |  | | | | | | | | | | | | | | | | | | | | | | | | | | | | | | | | | | | | | | | | | | | | | | | | | | | | | | | | | | | | | | | | | | | | | | | | | | | | | | | | | | | | | | | | | | | | | | | | | | | | | | | | | | | | | | | | | | | | | | | | | | | | | | | | | | | | | | | | | | | | | | | | | | | | | | | | | |
|----------|----------------------------------|---|--|---|------|-----------|-------|------|-----------|-------|------|-----------|-------|--------|-----------|-------|--------|-------|------|--------|-------|------|--------|-------|------|--------|-------|------|--------|-------|------|----------|----|---|----------|----|---|-----------|----|---|-----------|----|---|-----------|----|---|-----------|----|---|----------|----|---|----------|----|----|-----------|----|---|-----------|----|---|-----------|----|---|-----------|----|---|----------|----|---|----------|----|----|-----------|----|---|-----------|----|---|-----------|----|---|-----------|----|---|----------|----|---|----------|----|---|-----------|----|---|-----------|----|---|-----------|----|---|-----------|----|---|----------|----|---|----------|----|---|-----------|----|---|-----------|----|---|-----------|----|---|-----------|----|---|----------|----|---|----------|----|---|-----------|----|---|-----------|----|---|-----------|----|---|-----------|----|---|----------|----|---|----------|----|---|-----------|----|---|-----------|----|---|-----------|----|---|-----------|----|---|
| 71 | Yer Gömme Armatürleri |  |  |  | | | | | | | | | | | | | | | | | | | | | | | | | | | | | | | | | | | | | | | | | | | | | | | | | | | | | | | | | | | | | | | | | | | | | | | | | | | | | | | | | | | | | | | | | | | | | | | | | | | | | | | | | | | | | | | | | | | | | | | | | | | | | | | | | | | | | | | | | | | | | | | | | | | | | | | | | |
| 72 | Lambalar |  |  |  | | | | | | | | | | | | | | | | | | | | | | | | | | | | | | | | | | | | | | | | | | | | | | | | | | | | | | | | | | | | | | | | | | | | | | | | | | | | | | | | | | | | | | | | | | | | | | | | | | | | | | | | | | | | | | | | | | | | | | | | | | | | | | | | | | | | | | | | | | | | | | | | | | | | | | | | | |
| 76 | LED Şerit ve Sürücüler |  |  |  | | | | | | | | | | | | | | | | | | | | | | | | | | | | | | | | | | | | | | | | | | | | | | | | | | | | | | | | | | | | | | | | | | | | | | | | | | | | | | | | | | | | | | | | | | | | | | | | | | | | | | | | | | | | | | | | | | | | | | | | | | | | | | | | | | | | | | | | | | | | | | | | | | | | | | | | | |
| 77 | Neon LED ve Zincir Modül |  |  |  | | | | | | | | | | | | | | | | | | | | | | | | | | | | | | | | | | | | | | | | | | | | | | | | | | | | | | | | | | | | | | | | | | | | | | | | | | | | | | | | | | | | | | | | | | | | | | | | | | | | | | | | | | | | | | | | | | | | | | | | | | | | | | | | | | | | | | | | | | | | | | | | | | | | | | | | | |
| 78 | LED Bar ve Sürücüler |  |  |  | | | | | | | | | | | | | | | | | | | | | | | | | | | | | | | | | | | | | | | | | | | | | | | | | | | | | | | | | | | | | | | | | | | | | | | | | | | | | | | | | | | | | | | | | | | | | | | | | | | | | | | | | | | | | | | | | | | | | | | | | | | | | | | | | | | | | | | | | | | | | | | | | | | | | | | | | |
| 79 | Balast ve Kitler |  |  |  | | | | | | | | | | | | | | | | | | | | | | | | | | | | | | | | | | | | | | | | | | | | | | | | | | | | | | | | | | | | | | | | | | | | | | | | | | | | | | | | | | | | | | | | | | | | | | | | | | | | | | | | | | | | | | | | | | | | | | | | | | | | | | | | | | | | | | | | | | | | | | | | | | | | | | | | | |
| 80 | Komponentler |  |  |  | | | | | | | | | | | | | | | | | | | | | | | | | | | | | | | | | | | | | | | | | | | | | | | | | | | | | | | | | | | | | | | | | | | | | | | | | | | | | | | | | | | | | | | | | | | | | | | | | | | | | | | | | | | | | | | | | | | | | | | | | | | | | | | | | | | | | | | | | | | | | | | | | | | | | | | | | |
| 81 | Panolar |  |  | | | | | | | | | | | | | | | | | | | | | | | | | | | | | | | | | | | | | | | | | | | | | | | | | | | | | | | | | | | | | | | | | | | | | | | | | | | | | | | | | | | | | | | | | | | | | | | | | | | | | | | | | | | | | | | | | | | | | | | | | | | | | | | | | | | | | | | | | | | | | | | | | | | | | | | | | | |
| 82 | Anahtar ve Prizler |  |  |  | | | | | | | | | | | | | | | | | | | | | | | | | | | | | | | | | | | | | | | | | | | | | | | | | | | | | | | | | | | | | | | | | | | | | | | | | | | | | | | | | | | | | | | | | | | | | | | | | | | | | | | | | | | | | | | | | | | | | | | | | | | | | | | | | | | | | | | | | | | | | | | | | | | | | | | | | |
| 90 | Grup Prizler |  |  |  | | | | | | | | | | | | | | | | | | | | | | | | | | | | | | | | | | | | | | | | | | | | | | | | | | | | | | | | | | | | | | | | | | | | | | | | | | | | | | | | | | | | | | | | | | | | | | | | | | | | | | | | | | | | | | | | | | | | | | | | | | | | | | | | | | | | | | | | | | | | | | | | | | | | | | | | | |
| 93 | Fırsat Ürünleri |  |  |  | | | | | | | | | | | | | | | | | | | | | | | | | | | | | | | | | | | | | | | | | | | | | | | | | | | | | | | | | | | | | | | | | | | | | | | | | | | | | | | | | | | | | | | | | | | | | | | | | | | | | | | | | | | | | | | | | | | | | | | | | | | | | | | | | | | | | | | | | | | | | | | | | | | | | | | | | |
| | Kod İndeks | <table border="1"> <thead> <tr> <th>Kod No</th> <th>Sayfa</th> <th>Sıra</th> <th>Kod No</th> <th>Sayfa</th> <th>Sıra</th> <th>Kod No</th> <th>Sayfa</th> <th>Sıra</th> <th>Kod No</th> <th>Sayfa</th> <th>Sıra</th> <th>Kod No</th> <th>Sayfa</th> <th>Sıra</th> <th>Kod No</th> <th>Sayfa</th> <th>Sıra</th> </tr> </thead> <tbody> <tr> <td>3035 451</td> <td>59</td> <td>6</td> <td>4201 817</td> <td>35</td> <td>9</td> <td>5014 4582</td> <td>13</td> <td>3</td> <td>5021 1532</td> <td>37</td> <td>6</td> <td>5118 4611</td> <td>16</td> <td>3</td> <td>5413 2011</td> <td>32</td> <td>1</td> </tr> <tr> <td>3110 102</td> <td>84</td> <td>6</td> <td>4201 821</td> <td>35</td> <td>11</td> <td>5014 4711</td> <td>12</td> <td>2</td> <td>5021 1542</td> <td>37</td> <td>6</td> <td>5118 4621</td> <td>16</td> <td>3</td> <td>5413 2014</td> <td>32</td> <td>3</td> </tr> <tr> <td>3110 103</td> <td>84</td> <td>6</td> <td>4201 822</td> <td>35</td> <td>11</td> <td>5014 4712</td> <td>12</td> <td>2</td> <td>5021 1552</td> <td>37</td> <td>6</td> <td>5211 1010</td> <td>59</td> <td>2</td> <td>5413 2050</td> <td>99</td> <td>9</td> </tr> <tr> <td>3110 106</td> <td>84</td> <td>6</td> <td>4301 642</td> <td>81</td> <td>3</td> <td>5014 4731</td> <td>12</td> <td>2</td> <td>5021 1562</td> <td>37</td> <td>6</td> <td>5211 1013</td> <td>59</td> <td>2</td> <td>5413 2113</td> <td>32</td> <td>2</td> </tr> <tr> <td>3110 112</td> <td>84</td> <td>6</td> <td>4301 652</td> <td>81</td> <td>3</td> <td>5014 4732</td> <td>12</td> <td>2</td> <td>5021 1572</td> <td>37</td> <td>6</td> <td>5211 1014</td> <td>59</td> <td>2</td> <td>5413 2114</td> <td>32</td> <td>4</td> </tr> <tr> <td>3110 113</td> <td>84</td> <td>6</td> <td>4301 662</td> <td>81</td> <td>3</td> <td>5014 4741</td> <td>12</td> <td>2</td> <td>5021 1582</td> <td>37</td> <td>6</td> <td>5211 1110</td> <td>58</td> <td>5</td> <td>5511 2391</td> <td>83</td> <td>4</td> </tr> <tr> <td>3110 120</td> <td>84</td> <td>5</td> <td>4301 672</td> <td>81</td> <td>3</td> <td>5014 4742</td> <td>12</td> <td>2</td> <td>5021 8220</td> <td>36</td> <td>6</td> <td>5211 1115</td> <td>58</td> <td>5</td> <td>5511 2401</td> <td>83</td> <td>4</td> </tr> </tbody> </table> | | | | | | | | | | | | Kod No | Sayfa | Sıra | Kod No | Sayfa | Sıra | Kod No | Sayfa | Sıra | Kod No | Sayfa | Sıra | Kod No | Sayfa | Sıra | Kod No | Sayfa | Sıra | 3035 451 | 59 | 6 | 4201 817 | 35 | 9 | 5014 4582 | 13 | 3 | 5021 1532 | 37 | 6 | 5118 4611 | 16 | 3 | 5413 2011 | 32 | 1 | 3110 102 | 84 | 6 | 4201 821 | 35 | 11 | 5014 4711 | 12 | 2 | 5021 1542 | 37 | 6 | 5118 4621 | 16 | 3 | 5413 2014 | 32 | 3 | 3110 103 | 84 | 6 | 4201 822 | 35 | 11 | 5014 4712 | 12 | 2 | 5021 1552 | 37 | 6 | 5211 1010 | 59 | 2 | 5413 2050 | 99 | 9 | 3110 106 | 84 | 6 | 4301 642 | 81 | 3 | 5014 4731 | 12 | 2 | 5021 1562 | 37 | 6 | 5211 1013 | 59 | 2 | 5413 2113 | 32 | 2 | 3110 112 | 84 | 6 | 4301 652 | 81 | 3 | 5014 4732 | 12 | 2 | 5021 1572 | 37 | 6 | 5211 1014 | 59 | 2 | 5413 2114 | 32 | 4 | 3110 113 | 84 | 6 | 4301 662 | 81 | 3 | 5014 4741 | 12 | 2 | 5021 1582 | 37 | 6 | 5211 1110 | 58 | 5 | 5511 2391 | 83 | 4 | 3110 120 | 84 | 5 | 4301 672 | 81 | 3 | 5014 4742 | 12 | 2 | 5021 8220 | 36 | 6 | 5211 1115 | 58 | 5 | 5511 2401 | 83 | 4 |
| Kod No | Sayfa | Sıra | Kod No | Sayfa | Sıra | Kod No | Sayfa | Sıra | Kod No | Sayfa | Sıra | Kod No | Sayfa | Sıra | Kod No | Sayfa | Sıra | | | | | | | | | | | | | | | | | | | | | | | | | | | | | | | | | | | | | | | | | | | | | | | | | | | | | | | | | | | | | | | | | | | | | | | | | | | | | | | | | | | | | | | | | | | | | | | | | | | | | | | | | | | | | | | | | | | | | | | | | | | | | | | | | | | | | | | | | | | | |
| 3035 451 | 59 | 6 | 4201 817 | 35 | 9 | 5014 4582 | 13 | 3 | 5021 1532 | 37 | 6 | 5118 4611 | 16 | 3 | 5413 2011 | 32 | 1 | | | | | | | | | | | | | | | | | | | | | | | | | | | | | | | | | | | | | | | | | | | | | | | | | | | | | | | | | | | | | | | | | | | | | | | | | | | | | | | | | | | | | | | | | | | | | | | | | | | | | | | | | | | | | | | | | | | | | | | | | | | | | | | | | | | | | | | | | | | | |
| 3110 102 | 84 | 6 | 4201 821 | 35 | 11 | 5014 4711 | 12 | 2 | 5021 1542 | 37 | 6 | 5118 4621 | 16 | 3 | 5413 2014 | 32 | 3 | | | | | | | | | | | | | | | | | | | | | | | | | | | | | | | | | | | | | | | | | | | | | | | | | | | | | | | | | | | | | | | | | | | | | | | | | | | | | | | | | | | | | | | | | | | | | | | | | | | | | | | | | | | | | | | | | | | | | | | | | | | | | | | | | | | | | | | | | | | | |
| 3110 103 | 84 | 6 | 4201 822 | 35 | 11 | 5014 4712 | 12 | 2 | 5021 1552 | 37 | 6 | 5211 1010 | 59 | 2 | 5413 2050 | 99 | 9 | | | | | | | | | | | | | | | | | | | | | | | | | | | | | | | | | | | | | | | | | | | | | | | | | | | | | | | | | | | | | | | | | | | | | | | | | | | | | | | | | | | | | | | | | | | | | | | | | | | | | | | | | | | | | | | | | | | | | | | | | | | | | | | | | | | | | | | | | | | | |
| 3110 106 | 84 | 6 | 4301 642 | 81 | 3 | 5014 4731 | 12 | 2 | 5021 1562 | 37 | 6 | 5211 1013 | 59 | 2 | 5413 2113 | 32 | 2 | | | | | | | | | | | | | | | | | | | | | | | | | | | | | | | | | | | | | | | | | | | | | | | | | | | | | | | | | | | | | | | | | | | | | | | | | | | | | | | | | | | | | | | | | | | | | | | | | | | | | | | | | | | | | | | | | | | | | | | | | | | | | | | | | | | | | | | | | | | | |
| 3110 112 | 84 | 6 | 4301 652 | 81 | 3 | 5014 4732 | 12 | 2 | 5021 1572 | 37 | 6 | 5211 1014 | 59 | 2 | 5413 2114 | 32 | 4 | | | | | | | | | | | | | | | | | | | | | | | | | | | | | | | | | | | | | | | | | | | | | | | | | | | | | | | | | | | | | | | | | | | | | | | | | | | | | | | | | | | | | | | | | | | | | | | | | | | | | | | | | | | | | | | | | | | | | | | | | | | | | | | | | | | | | | | | | | | | |
| 3110 113 | 84 | 6 | 4301 662 | 81 | 3 | 5014 4741 | 12 | 2 | 5021 1582 | 37 | 6 | 5211 1110 | 58 | 5 | 5511 2391 | 83 | 4 | | | | | | | | | | | | | | | | | | | | | | | | | | | | | | | | | | | | | | | | | | | | | | | | | | | | | | | | | | | | | | | | | | | | | | | | | | | | | | | | | | | | | | | | | | | | | | | | | | | | | | | | | | | | | | | | | | | | | | | | | | | | | | | | | | | | | | | | | | | | |
| 3110 120 | 84 | 5 | 4301 672 | 81 | 3 | 5014 4742 | 12 | 2 | 5021 8220 | 36 | 6 | 5211 1115 | 58 | 5 | 5511 2401 | 83 | 4 | | | | | | | | | | | | | | | | | | | | | | | | | | | | | | | | | | | | | | | | | | | | | | | | | | | | | | | | | | | | | | | | | | | | | | | | | | | | | | | | | | | | | | | | | | | | | | | | | | | | | | | | | | | | | | | | | | | | | | | | | | | | | | | | | | | | | | | | | | | | |

Pelsan Slim LED Panel Ofis Armatürleri

Mioled 6x60 Sıva Altı 36W

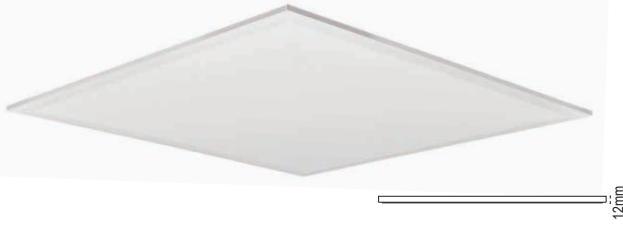

IP 40

| Kod No | Özellikler | Koli Adedi | Fiyat |
|-----------|------------------------|------------|----------|
| 5615 9890 | Mioled 36W 60X60 3000K | 5 | 43,40 \$ |
| 5615 8160 | Mioled 36W 60X60 4000K | 5 | 43,40 \$ |
| 5615 8170 | Mioled 36W 60X60 6500K | 5 | 43,40 \$ |

Mioled 6x60 Clip-in 36W

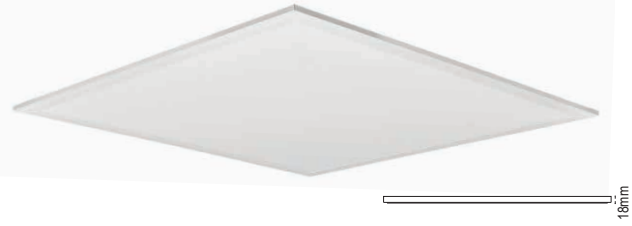

IP 40

| Kod No | Özellikler | Koli Adedi | Fiyat |
|-----------|--------------------------------|------------|----------|
| 5615 8310 | Mioled 36W 60X60 3000K Clip-in | 5 | 45,40 \$ |
| 5615 8380 | Mioled 36W 60X60 4000K Clip-in | 5 | 45,40 \$ |
| 5615 8390 | Mioled 36W 60X60 6500K Clip-in | 5 | 45,40 \$ |

Mioled 30x30 Sıva Altı 20W



IP40

| Kod No | Özellikler | Koli Adedi | Fiyat |
|-----------|------------------------|------------|----------|
| 5615 8200 | Mioled 20W 30X30 4000K | 10 | 22,60 \$ |
| 5615 8490 | Mioled 20W 30X30 6500K | 10 | 22,60 \$ |

Mioled 30x30 Clip-in 20W



IP40

| Kod No | Özellikler | Koli Adedi | Fiyat |
|-----------|--------------------------------|------------|----------|
| 5615 8450 | Mioled 20W 30x30 4000K Clip-in | 10 | 24,60 \$ |
| 5615 8460 | Mioled 20W 30x30 6500K Clip-in | 10 | 24,60 \$ |

Mioled 30x60 Sıva Altı 30W



IP 40

| Kod No | Özellikler | Koli Adedi | Fiyat |
|-----------|------------------------|------------|----------|
| 5615 8190 | Mioled 30W 30X60 4000K | 5 | 45,25 \$ |
| 5615 8480 | Mioled 30W 30X60 6500K | 5 | 45,25 \$ |

Mioled 30x120 Sıva Altı 40W



IP 40

| Kod No | Özellikler | Koli Adedi | Fiyat |
|-----------|-------------------------|------------|----------|
| 5615 8180 | Mioled 40W 30X120 4000K | 5 | 69,75 \$ |
| 5615 8470 | Mioled 40W 30X120 6500K | 5 | 69,75 \$ |

Opsiyonlar



| Kod No | Özellikler | Fiyat |
|-----------|--|------------|
| 5913 1470 | Panel Acil Ayd. Kiti (Tüm Paneller ile uyumlu) | 1 29,00 \$ |
| | Triac Dim | 1 28,50 \$ |
| | 1-10V Dim | 1 56,50 \$ |
| | DALI Dim | 1 56,50 \$ |

Panel Aksesuarları



| Kod No | Özellikler | Koli Adedi | Fiyat |
|-----------|----------------------------------|------------|---------|
| 5985 5710 | Askı Aksesuarı (4 Adet) | 1 | 5,55 \$ |
| 5985 5730 | Alçıpan Aksesuar Takımı(4 adet) | 1 | 3,00 \$ |

Mioled Performans



Yüksek Tavanlar için

- Mioled Performans, 3.50- 5.50 metre arasındaki tavan yüksekliğine sahip yapılarda gereken aydınlık düzeyini veren ideal bir çözümdür.
- 110 lm/W'ı aşan etkinlik faktörü ile yüksek performans sunar.

3,5 -5,5 m



Mioled Konfor



Yüksek Göz Konforu için

Mioled Konfor, özel difüzör ve LED çipleri sayesinde kamaşmayı engelleyerek işinize odaklanmanızı sağlar.



Mioled Performans



110 lm/W

12mm

IP 40

| Kod No | Özellikler | Koli Adedi | Fiyat |
|-----------|-----------------------------------|------------|----------|
| 5615 9960 | Mioled Performans 36W 60X60 6500K | 5 | 85,00 \$ |

Mioled Konfor

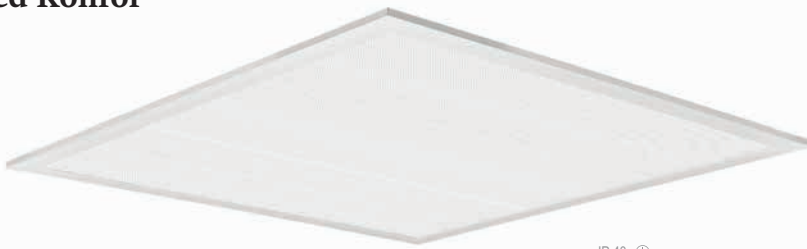

UGR < 19

12mm

IP 40

| Kod No | Özellikler | Koli Adedi | Fiyat |
|-----------|-------------------------------|------------|----------|
| 5615 9990 | Mioled Konfor 36W 60X60 6500K | 5 | 85,00 \$ |

Slim Panel

S.Ü Çerçeve Aparatı

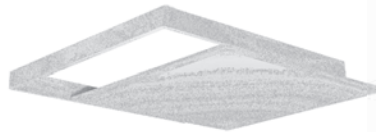
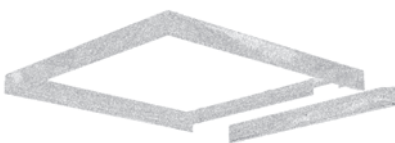

| Kod No | Özellikler | Koli Adedi | Fiyat |
|----------|--|------------|----------|
| 4201 085 | 60X60 Slim Panel S.Ü. Çerçeve Aparatı | 5 | 11,30 \$ |
| 4201 086 | 30X30 Slim Panel S.Ü. Çerçeve Aparatı | 5 | 7,10 \$ |
| 4201 087 | 30X60 Slim Panel S.Ü. Çerçeve Aparatı | 5 | 8,20 \$ |
| 4201 088 | 30X120 Slim Panel S.Ü. Çerçeve Aparatı | 5 | 11,30 \$ |

Isoled

Hem Hesaplı, Hem Tasarruflu



Pelsan 33W 60X60 backlight LED teknolojisi ile 4x18 parabolik'e eşdeğer aydınlatma

Üstelik 3 saate kadar acil aydınlatma ünite opsiyonlu



Kredi Yurtlar Kurumu ile hastane şartnamelerine uygun



Özel projeler için özel çözüm



Clip-in uygulaması ve acil aydınlatma ünite opsiyonlu



90 lm/W'ı aşan etkinlik faktörü



Avrupa driver opsiyonlu



1-10V dim ve DALI seçenekleri

Isoled Ambiyans



- Isoled Ambiyans, özel difüzörü sayesinde farklı açılardan farklı ışık hareleri sunar. Bu özel ışık hareleri sayesinde ofisinize dinamizm katar.



Kamaşma kontrollü özel difüzör



100 lm/W'ı aşan verimlilik



DALI, 1-10V dim ve acil aydınlatma kit opsiyonu



Clip-in opsiyonu



Avrupa driver opsiyonu

Farklı Açılardan Farklı Işık Hareleri Sunar



IP 40

| Kod No | Özellikler | Koli Adedi | Fiyat |
|-----------|--|------------|-----------|
| 5615 2901 | Isoled Ambiyans 12W 30X30 S.A. 4000 / 6500K | 5 | 81,00 \$ |
| 5615 2921 | Isoled Ambiyans 17W 30X60 S.A. 4000 / 6500K | 4 | 98,00 \$ |
| 5615 2931 | Isoled Ambiyans 33W 60X60 S.A. 4000 / 6500K | 5 | 104,00 \$ |
| 5615 2951 | Isoled Ambiyans 42W 60X60 S.A. 4000 / 6500K | 5 | 150,00 \$ |
| 5615 2971 | Isoled Ambiyans 33W 30X120 S.A. 4000 / 6500K | 4 | 218,00 \$ |

Isoled 60x60
Sıva Altı 42/33W



IP 40

| Kod No | Özellikler | Koli Adedi | Fiyat |
|-----------|----------------------------------|------------|----------|
| 5615 8770 | Isoled 42W 60X60 S.A. 4000/6500K | 5 | 75,00 \$ |
| 5615 3011 | Isoled 33W 60x60 S.A. 4000/6500K | 5 | 52,00 \$ |

Isoled 60x60
Clip-in 42/33W



IP 40

| Kod No | Özellikler | Koli Adedi | Fiyat |
|-----------|-------------------------------------|------------|----------|
| 5615 8870 | Isoled 42W 60X60 Clip-in 4000/6500K | 5 | 77,00 \$ |
| 5615 3021 | Isoled 33W 60x60 Clip-in 4000/6500K | 5 | 54,00 \$ |

Isoled 30x30
Sıva Altı 12W



IP 40

| Kod No | Özellikler | Koli Adedi | Fiyat |
|-----------|----------------------------------|------------|----------|
| 5615 8750 | Isoled 12W 30X30 S.A. 4000/6500K | 5 | 40,50 \$ |

Isoled 30x30
Clip-in 12W



IP 40

| Kod No | Özellikler | Koli Adedi | Fiyat |
|-----------|--|------------|----------|
| 5615 8880 | Isoled 12W 30X30 S.A. Clip-in 4000/6500K | 5 | 42,50 \$ |

Isoled 30x60
Sıva Altı 17W



IP 40

| Kod No | Özellikler | Koli Adedi | Fiyat |
|-----------|----------------------------------|------------|----------|
| 5615 8760 | Isoled 17W 30X60 S.A. 4000/6500K | 4 | 49,00 \$ |

Isoled 30x120
Sıva Altı 33W



IP 40

| Kod No | Özellikler | Koli Adedi | Fiyat |
|-----------|-----------------------------------|------------|----------|
| 5615 8780 | Isoled 33W 30X120 S.A. 4000/6500K | 4 | 73,50 \$ |

Clipped 30x30
Clip-in 20W



IP 40

| Kod No | Özellikler | Koli Adedi | Fiyat |
|-----------|---------------------------------|------------|----------|
| 5615 1050 | Clipped 20W 30X30 Clip-in 4000K | 20 | 28,35 \$ |
| 5615 1060 | Clipped 20W 30X30 Clip-in 6500K | 20 | 28,35 \$ |

Yeni Ürün

Opsiyonlar ve Aksesuarlar



IP 40

| Kod No | Özellikler | Koli Adedi | Fiyat |
|-----------|---|------------|----------|
| 5985 5740 | Isoled Alçıpan Aksesuar Takımı (4 adet) | 1 | 3,00 \$ |
| 5913 1470 | Isoled Acil Ayd. Kiti (Tüm Paneller ile uyumlu) | 1 | 29,00 \$ |
| | Triac Dim | 1 | 28,50 \$ |
| | 1-10V Dim | 1 | 56,50 \$ |
| | DALI Dim | 1 | 56,50 \$ |

Pelsan Sıva Altı ve Sıva Üstü Backlight Ofis Armatürleri

Fioled S.A. / Clip-in



Fioled1 30x30

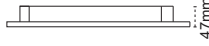

IP 40



Fioled2 60x60

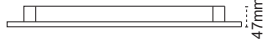

47mm

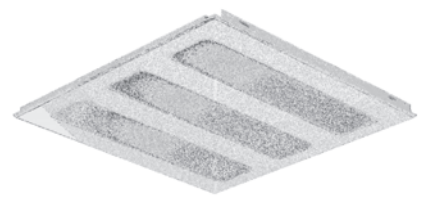

Fioled3 60x60

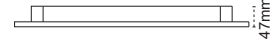

47mm

| Kod No | Özellikler | Koli Adedi | Fiyat | Kod No | Özellikler | Koli Adedi | Fiyat | Kod No | Özellikler | Koli Adedi | Fiyat |
|-----------|-----------------------------|------------|----------|-----------|------------------------------|------------|----------|-----------|------------------------------|------------|----------|
| 5616 6621 | 8W 30X30 S.A. 4000/6500K | 4 | 53,50 \$ | 5616 6541 | 33W 60X60 S.A. 4000/6500K | 4 | 72,50 \$ | 5616 6581 | 33W 60X60 S.A. 4000/6500K | 4 | 72,50 \$ |
| 5616 6641 | 8W 30X30 Clip-in 4000/6500K | 4 | 55,50 \$ | 5616 6561 | 33W 60X60 Clip-in 4000/6500K | 4 | 74,50 \$ | 5616 6601 | 33W 60X60 Clip-in 4000/6500K | 4 | 74,50 \$ |

Fioled S.Ü.

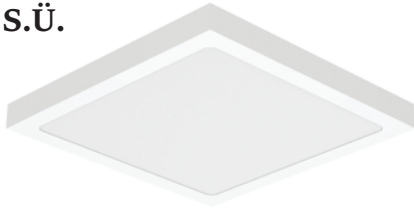

Fioled1 60x60



IP 40



Fioled3 60x60



56mm

| Kod No | Özellikler | Koli Adedi | Fiyat | Kod No | Özellikler | Koli Adedi | Fiyat | | |
|-----------|-----------------|------------|-------|-----------|------------|----------------|------------|---|----------|
| 5616 6631 | 8W 30X30 S.Ü. | 4000/6500K | 4 | 63,00 \$ | 5616 6591 | 33W 60X60 S.Ü. | 4000/6500K | 4 | 78,50 \$ |
| 5616 6671 | 17W 30X60 S.Ü. | 4000/6500K | 4 | 73,00 \$ | | | | | |
| 5616 6511 | 33W 60X60 S.Ü. | 4000/6500K | 4 | 76,50 \$ | | | | | |
| 5616 6711 | 30W 30X120 S.Ü. | 4000/6500K | 4 | 100,00 \$ | | | | | |

Seoled S.A. / Clip-in



Seoled1 30x30



IP 40



Seoled2 60x60

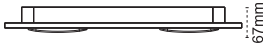

67mm



Seoled3 60x60



67mm

| Kod No | Özellikler | Koli Adedi | Fiyat | Kod No | Özellikler | Koli Adedi | Fiyat | Kod No | Özellikler | Koli Adedi | Fiyat |
|-----------|-----------------------------|------------|----------|-----------|------------------------------|------------|----------|-----------|------------------------------|------------|----------|
| 5616 6131 | 8W 30X30 S.A. 4000/6500K | 4 | 57,50 \$ | 5616 6051 | 30W 60X60 S.A. 4000/6500K | 4 | 76,50 \$ | 5616 6091 | 30W 60X60 S.A. 4000/6500K | 4 | 76,50 \$ |
| 5616 6151 | 8W 30X30 Clip-in 4000/6500K | 4 | 59,50 \$ | 5616 6071 | 30W 60X60 Clip-in 4000/6500K | 4 | 78,50 \$ | 5616 6111 | 30W 60X60 Clip-in 4000/6500K | 4 | 78,50 \$ |

Seoled S.Ü.



Seoled1 60x60

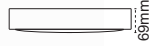

IP 40



Seoled3 60x60

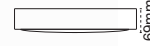

69mm

| Kod No | Özellikler | Koli Adedi | Fiyat | Kod No | Özellikler | Koli Adedi | Fiyat | | |
|-----------|-----------------|------------|-------|-----------|------------|-----------------|------------|---|----------|
| 5616 6141 | 8W 30X30 S.Ü. | 4000/6500K | 4 | 67,00 \$ | 5616 6101 | 30W 60X360 S.Ü. | 4000/6500K | 4 | 82,50 \$ |
| 5616 6181 | 17W 30X60 S.Ü. | 4000/6500K | 4 | 77,00 \$ | | | | | |
| 5616 6021 | 33W 60X60 S.Ü. | 4000/6500K | 4 | 80,50 \$ | | | | | |
| 5616 6221 | 30W 30X120 S.Ü. | 4000/6500K | 4 | 104,00 \$ | | | | | |

Opsiyon Farkları

| Kod No | Özellikler | Koli Adedi | Fiyat |
|-----------|------------------------------|------------|----------|
| 5913 1470 | Seoled-Fioled Acil Ayd. Kiti | 1 | 29,00 \$ |
| 3180 197 | Alçıpan yayı (4 adet) | 1 | 3,00 \$ |

Dekaled



Dekoled

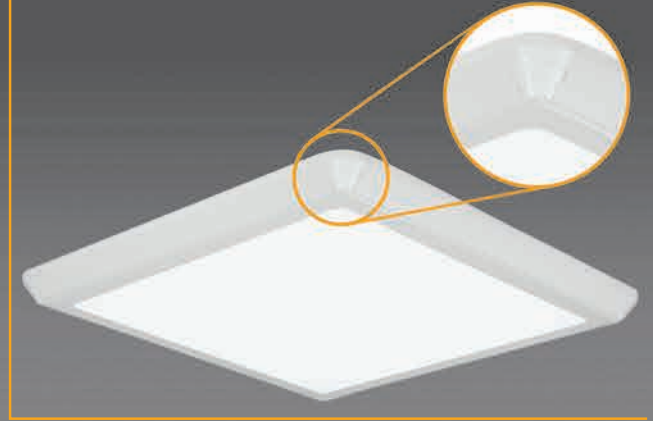

Estetik Tasarımlarıyla Yenilikçi Çözümler

Dekaled 60x60



IP 40

53mm

| Kod No | Özellikler | Koli Adedi | Fiyat |
|-----------|-----------------------------------|------------|----------|
| 5615 3111 | Dekaled 33W 60X60 S.Ü. 4000/6500K | 5 | 66,50 \$ |
| 5615 3131 | Dekaled 42W 60x60 S.Ü. 4000/6500K | 5 | 78,50 \$ |

Dekoled 60x60



IP 40

50mm

| Kod No | Özellikler | Koli Adedi | Fiyat |
|-----------|-----------------------------------|------------|----------|
| 5615 8670 | Dekoled 33W 60X60 S.Ü. 4000/6500K | 5 | 58,50 \$ |
| 5615 8641 | Dekoled 42W 60x60 S.Ü. 4000/6500K | 5 | 70,50 \$ |

Dekaled

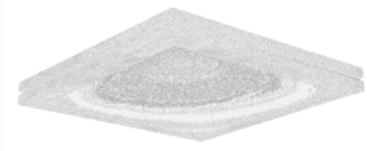

IP 40

53mm

| Kod No | Özellikler | Koli Adedi | Fiyat |
|-----------|------------------------------------|------------|-----------|
| 5615 3191 | Dekaled 12W 30X30 S.Ü. 4000/6500K | 4 | 55,00 \$ |
| 5615 3171 | Dekaled 17W 30X60 S.Ü. 4000/6500K | 4 | 63,50 \$ |
| 5615 3141 | Dekaled 33W 30X120 S.Ü. 4000/6500K | 4 | 88,00 \$ |
| 5615 3151 | Dekaled 42W 30x120 S.Ü. 4000/6500K | 4 | 100,00 \$ |

Dekoled



IP 40

50mm

| Kod No | Özellikler | Koli Adedi | Fiyat |
|-----------|------------------------------------|------------|----------|
| 5615 8650 | Dekoled 12W 30X30 S.Ü. 4000/6500K | 5 | 46,50 \$ |
| 5615 8660 | Dekoled 17W 30X60 S.Ü. 4000/6500K | 5 | 55,00 \$ |
| 5615 8680 | Dekoled 42W 30X120 S.Ü. 4000/6500K | 4 | 79,50 \$ |

Opsiyon Farkları

| Kod No | Özellikler | Koli Adedi | Fiyat |
|-----------|--------------------------------------|------------|---------|
| 5913 1470 | Sıva Üstü Panel Acil Aydınlatma Kiti | 1 | 29,00\$ |

Pelsan Sıva Altı & Sıva Üstü Ofis Armatürleri

Isolamp T5



IP 20 ☺

| Kod No | Özellikler | Koli Adedi | Fiyat |
|-----------|-------------------------|------------|----------|
| 5014 4022 | 2X14W T5 Elk. Bal. S.A. | 6 | 33,00 \$ |
| 5014 4032 | 3X14W T5 Elk. Bal. S.A. | 6 | 38,50 \$ |
| 5014 4042 | 4X14W T5 Elk. Bal. S.A. | 6 | 38,50 \$ |
| 5014 4212 | 2X28W T5 Elk. Bal. S.A. | 4 | 38,50 \$ |
| 5014 6502 | 4X14W T5 Elk. Clip-in | 6 | 40,50 \$ |

Dekolamp1 T5



IP 20 ☺

| Kod No | Özellikler | Koli Adedi | Fiyat |
|-----------|-------------------------|------------|----------|
| 5014 5562 | 2X14W T5 Elk. Bal. S.Ü. | 6 | 35,00 \$ |
| 5014 5582 | 4X14W T5 Elk. Bal. S.Ü. | 6 | 40,50 \$ |
| 5014 5602 | 2X28W T5 Elk. Bal. S.Ü. | 4 | 40,50 \$ |

7 Lamel Çift Parabolik



IP 20 ☺

| Kod No | Özellikler | Koli Adedi | Fiyat |
|-----------|--------------------------|------------|----------|
| 5014 4762 | 2X18W TLD Elk. Bal. S.A. | 4 | 31,60 \$ |
| 5014 4772 | 4X18W TLD Elk. Bal. S.A. | 4 | 35,60 \$ |
| 5014 4782 | 2X36W TLD Elk. Bal. S.A. | 4 | 35,60 \$ |

Dekolamp



IP 20 ☺

| Kod No | Özellikler | Koli Adedi | Fiyat |
|-----------|--------------------------|------------|----------|
| 5014 7252 | 2X18W TLD Elk. Bal. S.Ü. | 6 | 33,60 \$ |
| 5014 7262 | 4X18W TLD Elk. Bal. S.Ü. | 6 | 37,60 \$ |
| 5014 7272 | 2X36W TLD Elk. Bal. S.Ü. | 4 | 37,60 \$ |

Prizmatik Lensli-Opal Lensli



IP 40 ☺

| Kod No | Özellikler | Lens | Koli Adedi | Fiyat |
|-----------|--------------------------|-----------|------------|----------|
| 5014 1912 | 2X18W TLD Elk. Bal. S.A. | Prizmatik | 4 | 31,60 \$ |
| 5014 1922 | 4X18W TLD Elk. Bal. S.A. | Prizmatik | 4 | 35,60 \$ |
| 5014 1932 | 2X36W TLD Elk. Bal. S.A. | Prizmatik | 4 | 35,60 \$ |
| 5014 6012 | 2X18W TLD Elk. Bal. S.A. | Opal | 4 | 35,60 \$ |
| 5014 6022 | 4X18W TLD Elk. Bal. S.A. | Opal | 4 | 39,60 \$ |
| 5014 6032 | 2X36W TLD Elk. Bal. S.A. | Opal | 4 | 39,60 \$ |

Dekolamp Prizmatik-Opal Lensli



IP 40 ☺

| Kod No | Özellikler | Lens | Koli Adedi | Fiyat |
|-----------|--------------------------|-----------|------------|----------|
| 5014 4552 | 2X18W TLD Elk. Bal. S.Ü. | Prizmatik | 6 | 33,60 \$ |
| 5014 4562 | 4X18W TLD Elk. Bal. S.Ü. | Prizmatik | 6 | 37,60 \$ |
| 5014 4572 | 2X36W TLD Elk. Bal. S.Ü. | Prizmatik | 4 | 37,60 \$ |
| 5014 7382 | 2X18W TLD Elk. Bal. S.Ü. | Opal | 6 | 37,60 \$ |
| 5014 7392 | 4X18W TLD Elk. Bal. S.Ü. | Opal | 6 | 41,00 \$ |
| 5014 7402 | 2X36W TLD Elk. Bal. S.Ü. | Opal | 4 | 41,00 \$ |

Endirekt 1 Perfore

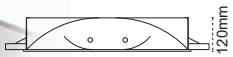

IP 20 ☺

| Kod No | Özellikler | Koli Adedi | Fiyat |
|-----------|-------------------------|------------|----------|
| 5014 8542 | 3X24W T5 Elk. Bal. S.A. | 3 | 68,00 \$ |
| 5014 8532 | 2X24W T5 Elk. Bal. S.A. | 3 | 58,00 \$ |

Dekolamp Endirekt Perfore

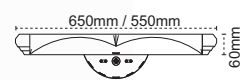

IP 20 ☺

| Kod No | Özellikler | Koli Adedi | Fiyat |
|-----------|-------------------------|------------|----------|
| 5014 9882 | 2X24W T5 Elk. Bal. S.Ü. | 3 | 61,00 \$ |
| 5014 9892 | 3X24W T5 Elk. Bal. S.Ü. | 3 | 70,00 \$ |

IP65 LED Steril S.A. Temperli Kumlu Camlı



IP 65

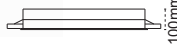

| Kod No | Özellikler | Koli Adedi | Fiyat |
|-----------|---|------------|-----------|
| 5615 8811 | LED Steril IP65 33W 60x60 S.A. 4000/6500K | 4 | 145,00 \$ |

IP65 LED Steril S.Ü. Temperli Kumlu Camlı



IP 65

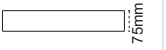

| Kod No | Özellikler | Koli Adedi | Fiyat |
|-----------|---|------------|-----------|
| 5615 8001 | LED Steril IP65 33W 60x60 S.Ü. 4000/6500K | 4 | 152,00 \$ |

IP65 Steril S.A. Temperli Kumlu Camlı



IP 65



| Kod No | Özellikler | Koli Adedi | Fiyat |
|-----------|--------------------------|------------|----------|
| 5014 2912 | 2X18W TLD Elk. Bal. S.A. | 4 | 61,00 \$ |
| 5014 2922 | 4X18W TLD Elk. Bal. S.A. | 3 | 73,00 \$ |
| 5014 2932 | 2X36W TLD Elk. Bal. S.A. | 3 | 76,00 \$ |
| 5011 1002 | 2X14W T5 Elk. Bal. S.A. | 4 | 63,00 \$ |
| 5011 0842 | 4X14W T5 Elk. Bal. S.A. | 3 | 75,00 \$ |
| 5011 0832 | 2X28W T5 Elk. Bal. S.A. | 3 | 78,00 \$ |

IP65 Steril S.Ü. Temperli Kumlu Camlı



IP 65

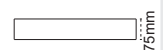

| Kod No | Özellikler | Koli Adedi | Fiyat |
|-----------|--------------------------|------------|----------|
| 5014 2812 | 2X18W TLD Elk. Bal. S.Ü. | 4 | 66,00 \$ |
| 5014 2822 | 4X18W TLD Elk. Bal. S.Ü. | 4 | 78,00 \$ |
| 5014 2832 | 2X36W TLD Elk. Bal. S.Ü. | 4 | 81,00 \$ |
| 5014 2862 | 2X14W T5 Elk. Bal. S.Ü. | 4 | 68,00 \$ |
| 5014 5342 | 4X14W T5 Elk. Bal. S.Ü. | 4 | 80,00 \$ |
| 5014 5142 | 2X28W T5 Elk. Bal. S.Ü. | 4 | 84,00 \$ |

IP65 Steril S.A. Temperli Camlı



IP 65

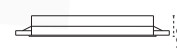

| Kod No | Özellikler | Koli Adedi | Fiyat |
|-----------|--------------------------|------------|----------|
| 5014 5162 | 2X18W TLD Elk. Bal. S.A. | 4 | 67,00 \$ |
| 5014 5132 | 4X18W TLD Elk. Bal. S.A. | 3 | 82,00 \$ |
| 5014 5172 | 2X36W TLD Elk. Bal. S.A. | 3 | 85,00 \$ |

IP65 Steril S.Ü. Temperli Camlı

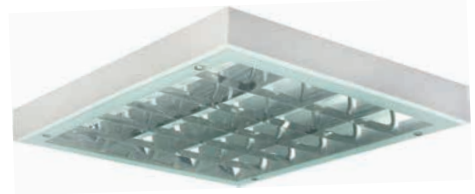

IP 65



| Kod No | Özellikler | Koli Adedi | Fiyat |
|-----------|--------------------------|------------|----------|
| 5014 4402 | 2X18W TLD Elk. Bal. S.Ü. | 4 | 72,00 \$ |
| 5014 4412 | 4X18W TLD Elk. Bal. S.Ü. | 4 | 87,00 \$ |
| 5014 4422 | 2X36W TLD Elk. Bal. S.Ü. | 4 | 90,00 \$ |

Mikrop Kırıcı



axbxcmm
1x15:535x121x126
1x30:990x121x126

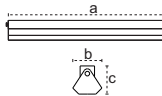

IP 20

| Kod No | Özellikler | Koli Adedi | Fiyat |
|-----------|--------------------------|------------|----------|
| 5014 4482 | 1X15W TLD Elk. Bal. S.Ü. | 1 | 39,50 \$ |
| 5014 4492 | 1X30W TLD Elk. Bal. S.Ü. | 1 | 45,00 \$ |

Negatoskop

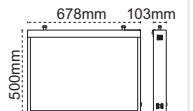

IP 40

| Kod No | Özellikler | Koli Adedi | Fiyat |
|-----------|---------------------------|------------|-----------|
| 5615 8540 | Negatoskop 42W LED 60X60 | 1 | 152,00 \$ |
| 5615 8550 | Negatoskop 84W LED 60X120 | 1 | 210,00 \$ |

Halley LED
60x60 S.A

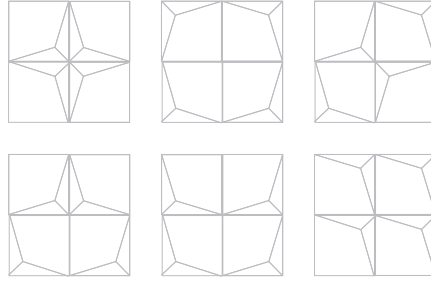

4'lü kullanım önerisi

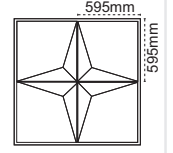

IP 40 ⊕

Kod No Özellikler
5615 9231 Halley 33W 60x60 S.A. 4000/6500K

Koli Adedi Fiyat
4 115,00 \$

Galaxy LED
60x60 S.A

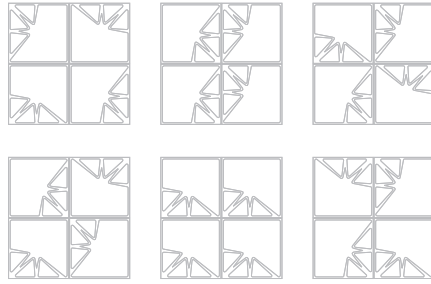

4'lü kullanım önerisi

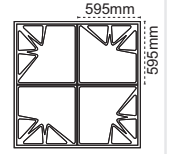

IP 40 ⊕

Kod No Özellikler
5615 9271 Galaxy 33W 60x60 S.A. 4000/6500K

Koli Adedi Fiyat
4 115,00 \$

Cion LED
60x60 S.A

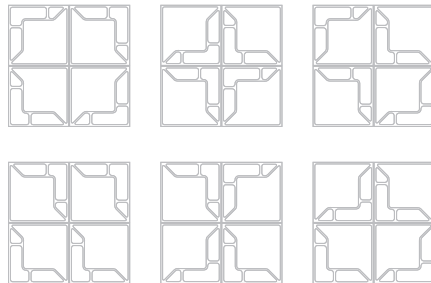

4'lü kullanım önerisi

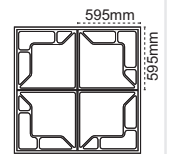

IP 40 ⊕

Kod No Özellikler
5615 9201 Cion 33W 60x60 S.A. 4000/6500K

Koli Adedi Fiyat
4 105,00 \$

Gupur LED
60x60 S.A

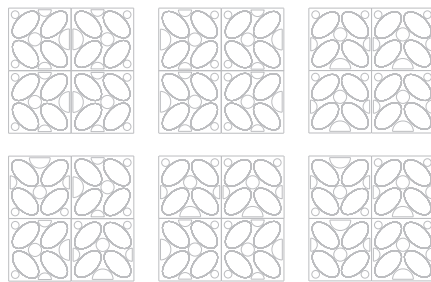

4'lü kullanım önerisi

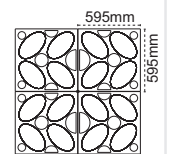

IP 40 ⊕

Kod No Özellikler
5615 9141 Gupur 33W 60x60 S.A. 4000/6500K

Koli Adedi Fiyat
4 105,00 \$

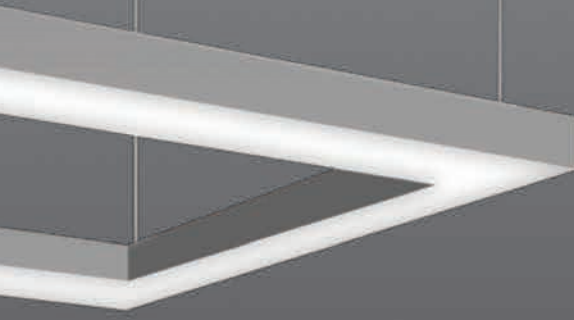

Quad LED



Circa LED



Polaris LED

Opsiyonları

- DALI
- 1-10V Dim
- 3 saate kadar acil aydınlatma

Renk Opsiyonları

- RAL 9005 - Siyah
- RAL 9006 - Gri
- RAL 9016 - Beyaz

● Askı aparatı dahildir.

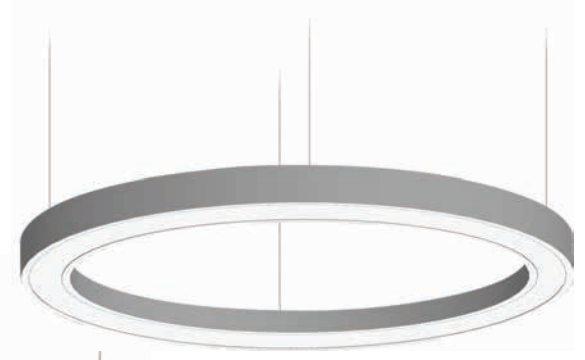

Quad LED

| Kod No | Özellikler | Koli Adedi | Fiyat |
|-----------|----------------------|------------|-----------|
| 5615 9291 | 20W 3000/4000/6500K | 1 | 198,00 \$ |
| 5615 9341 | 75W 3000/4000/6500K | 1 | 270,00 \$ |
| 5615 9391 | 100W 3000/4000/6500K | 1 | 330,00 \$ |

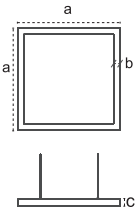

axbcm
 20W : 400x57x100
 75W : 600x57x100
 100W : 900x57x100

Polaris LED

| Kod No | Özellikler | Koli Adedi | Fiyat |
|-----------|---------------------|------------|-----------|
| 5615 6171 | 40W 3000/4000/6500K | 1 | 220,00 \$ |
| 5615 6181 | 60W 3000/4000/6500K | 1 | 280,00 \$ |
| 5615 6191 | 70W 3000/4000/6500K | 1 | 370,00 \$ |

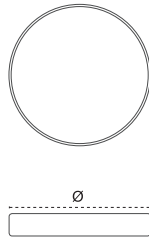

Øxhmm
 40W : 400x75
 60W : 600x75
 70W : 900x75

Circa LED

| Kod No | Özellikler | Koli Adedi | Fiyat |
|-----------|----------------------|------------|-----------|
| 5615 6121 | 45W 3000/4000/6500K | 1 | 280,00 \$ |
| 5615 6131 | 65W 3000/4000/6500K | 1 | 330,00 \$ |
| 5615 6141 | 100W 3000/4000/6500K | 1 | 410,00 \$ |

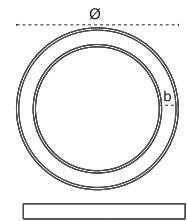

Øxbcm
 45W : 600x74x100
 65W : 900x74x100
 100W : 1200x74x100

Recta

3 Metreye Kadar Kesintisiz Gövde Seçeneği



- Avrupa LED Çip ve Driver

- Renk Opsiyonları**
- RAL 9005 - Siyah
 - RAL 9006 - Gri
 - RAL 9016 - Beyaz

- Opsiyonlar**
- 1-10V Dim
 - DALI Dim
 - 3 saate kadar acil aydınlatma

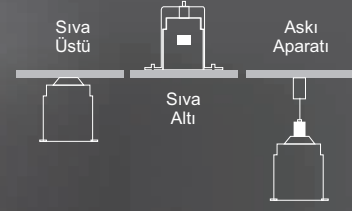

Recta Lux LED Sıva Üstü



IP 40

| Kod No | Özellikler | a x b x c | Koli Adedi | Fiyat |
|-----------|--------------------------|---------------|------------|-----------|
| 5615 9301 | 20W 4000/6500K | 600X58X76 mm | 1 | 62,50 \$ |
| 5615 9311 | 36W 4000/6500K | 900X58X76 mm | 1 | 93,50 \$ |
| 5615 9321 | 48W 4000/6500K | 1200X58X76 mm | 1 | 104,00 \$ |
| 5615 9331 | 61W 4000/6500K | 1500X58X76 mm | 1 | 135,00 \$ |
| 3220 326 | Recta Askı Aparatı 100cm | | 1 | 11,00 \$ |

Recta Lux LED Sıva Üstü



IP 40

| Kod No | Özellikler | a x b x c | Koli Adedi | Fiyat |
|-----------|--------------------------|------------|------------|-----------|
| 5615 9491 | 20W 4000/6500K | 600X85X76 | 1 | 61,50 \$ |
| 5615 9501 | 36W 4000/6500K | 900X85X76 | 1 | 94,50 \$ |
| 5615 9511 | 48W 4000/6500K | 1200X85X76 | 1 | 105,00 \$ |
| 5615 9521 | 61W 4000/6500K | 1500X85X76 | 1 | 136,00 \$ |
| 3220 335 | Recta Askı Aparatı 150cm | | 1 | 14,00 \$ |

Recta Lux LED Sıva Altı

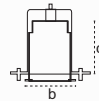

IP 40

| Kod No | Özellikler | a x b x c | □ (mm) | Koli Adedi | Fiyat |
|-----------|----------------|------------|---------|------------|-----------|
| 5615 9411 | 36W 4000/6500K | 916X76X76 | 902x60 | 1 | 93,50 \$ |
| 5615 9421 | 48W 4000/6500K | 1236X76X76 | 1222x60 | 1 | 104,00 \$ |
| 5615 9431 | 61W 4000/6500K | 1526X76X76 | 1512x60 | 1 | 134,00 \$ |

Recta Lux LED Sıva Altı

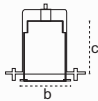

IP 40

| Kod no | Özellikler | a x b x c | □ (mm) | Koli Adedi | Fiyat |
|-----------|----------------|-------------|---------|------------|-----------|
| 5615 9601 | 36W 4000/6500K | 916X108X76 | 902x87 | 1 | 94,50 \$ |
| 5615 9611 | 48W 4000/6500K | 1236X108X76 | 1222x87 | 1 | 105,00 \$ |
| 5615 9621 | 61W 4000/6500K | 1526X108X76 | 1512x87 | 1 | 136,00 \$ |

Lineer Aydınlatmada İnce Çizgiler

- 4000K/6500K renk sıcaklığı seçenekleri mevcuttur.
- Avrupa menşei LED sürücü

Recta LED Slim Gümüş Sarkıt

Yeni Ürün



- 1m askı aparatı dahildir.

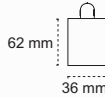

IP 40

| Kod No | Özellikler | Koli Adedi | Fiyat |
|-----------|------------------------|------------|---------|
| 5023 2081 | 25W 4000/6500K 1200 mm | 12 | 53,60\$ |

Recta LED Slim Siyah Sarkıt

Yeni Ürün



- 1m askı aparatı dahildir.

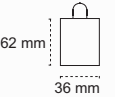

IP 40

| Kod No | Özellikler | Koli Adedi | Fiyat |
|-----------|------------------------|------------|---------|
| 5023 2031 | 25W 4000/6500K 1200 mm | 12 | 53,60\$ |

Recta LED Sıva Üstü

Yeni Ürün

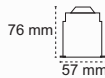

IP 40

| Kod No | Özellikler | Koli Adedi | Fiyat |
|-----------|------------------------|------------|----------|
| 5023 2111 | 20W 6500K 600 mm | 1 | 42,00 \$ |
| 5023 2121 | 20W 6500K 1200 mm | 1 | 52,00 \$ |
| 5023 2131 | 36W 4000/6500K 1200 mm | 1 | 56,00 \$ |

Recta LED Sıva Altı

Yeni Ürün

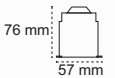

IP 40

| Kod No | Özellikler | Koli Adedi | Fiyat |
|-----------|------------------------|------------|----------|
| 5023 2211 | 20W 6500K 600 mm | 1 | 42,00 \$ |
| 5023 2221 | 20W 6500K 1200 mm | 1 | 52,00 \$ |
| 5023 2231 | 36W 4000/6500K 1200 mm | 1 | 56,00 \$ |



Volga Alüminyum Gövde



IP 20 ⊕

| Kod No | Özellikler | Koli Adedi | Fiyat |
|-----------|---------------------|------------|----------|
| 5616 4751 | Volga 50W LED Beyaz | 6 | 75,40 \$ |
| 5616 4741 | Volga 50W LED Gümüş | 6 | 75,40 \$ |
| 5616 4791 | Volga 50W LED Altın | 6 | 75,40 \$ |
| 5212 4011 | Volga E27 Gümüş | 6 | 37,80 \$ |
| 5212 4021 | Volga E27 Beyaz | 6 | 37,80 \$ |
| 5212 4061 | Volga E27 Altın | 6 | 37,80 \$ |

Rodos Alüminyum Gövde



IP 20 ⊕

| Kod No | Özellikler | Koli Adedi | Fiyat |
|-----------|-----------------------|------------|----------|
| 5118 4221 | Rodos E27 Siyah | 4 | 28,30 \$ |
| 5118 4211 | Rodos E27 Beyaz | 4 | 28,30 \$ |
| 5118 4241 | Rodos E27 Bakır Oksit | 4 | 28,30 \$ |
| 5118 4231 | Rodos E27 Altın Oksit | 4 | 28,30 \$ |

Virgo

Yeni
Ürün



IP 20 ⊕

| Kod No | Özellikler | Koli Adedi | Fiyat |
|-----------|---------------------|------------|-----------|
| 5615 6521 | Virgo 10W LED Beyaz | 1 | 109,00 \$ |

Pico Alüminyum Gövde



IP 20 ⊕

| Kod No | Özellikler | Koli Adedi | Fiyat |
|-----------|----------------|------------|----------|
| 5118 4621 | Pico E27 Siyah | 4 | 28,30 \$ |
| 5118 4611 | Pico E27 Beyaz | 4 | 28,30 \$ |



Beraberinde kullanılacak LED lambalar için sayfa 73'ü inceleyebilirsiniz.

Simi

Alüminyum Gövde

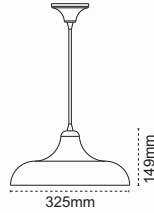

IP 20

Kod No Özellikler
5118 4411 Simi E27 Gri

Koli Adedi Fiyat
4 28,30 \$

Avsha

Alüminyum Gövde

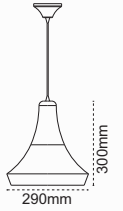

IP 20

Kod No Özellikler
5118 4011 Avsha E27 Siyah
5118 4021 Avsha E27 Gri

Koli Adedi Fiyat
4 28,30 \$
4 28,30 \$

Metal Sarkıt

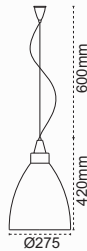

IP 20

Kod No Özellikler
5118 2020 Dekoratif Sarkıt E27 Q28

Koli Adedi Fiyat
1 33,25 \$

Tuna / Sana

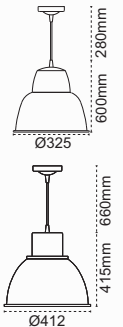

IP 20

Kod No Özellikler
5213 5010 Tuna E27 Q33
5213 5110 Sana E27 Q44

Koli Adedi Fiyat
4 22,50 \$
4 37,00 \$

Sırma



**7 Farklı Güç, 7 Farklı Boyut,
Şimdi Çok Özel Fiyatlara.**

Üstelik TSE Belgeli!

- 1W=1W çeker
- Pelsan Slim LED Downlightlar beyan ettiği güç ve lümeni verir.
- Alüminyum gövde, alüminyum çerçeve
- 3 saate kadar acil aydınlatma ünite opsiyonu

Sırma 3W

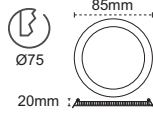

IP 40

| Kod No | Özellikler | Koli Adedi | Fiyat |
|-----------|------------|------------|---------|
| 5616 1991 | 3W 3000K | 60 | 3,30 \$ |
| 5616 2001 | 3W 4000K | 60 | 3,30 \$ |
| 5616 2011 | 3W 6500K | 60 | 3,30 \$ |

Sırma 6W

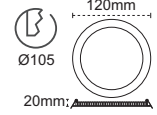

IP 40

| Kod No | Özellikler | Koli Adedi | Fiyat |
|-----------|------------|------------|---------|
| 5616 2021 | 6W 3000K | 30 | 4,75 \$ |
| 5616 2041 | 6W 4000K | 30 | 4,75 \$ |
| 5616 2031 | 6W 6500K | 30 | 4,75 \$ |

Sırma 9W



IP 40

| Kod No | Özellikler | Koli Adedi | Fiyat |
|-----------|------------|------------|---------|
| 5616 2101 | 9W 3000K | 30 | 5,90 \$ |
| 5616 2051 | 9W 4000K | 30 | 5,90 \$ |
| 5616 2061 | 9W 6500K | 30 | 5,90 \$ |

Sırma 12W

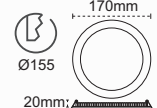

IP 40

| Kod No | Özellikler | Koli Adedi | Fiyat |
|-----------|------------|------------|---------|
| 5616 2091 | 12W 3000K | 30 | 8,20 \$ |
| 5616 2071 | 12W 4000K | 30 | 8,20 \$ |
| 5616 2081 | 12W 6500K | 30 | 8,20 \$ |

Sırma 15W

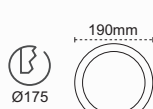

IP 40

| Kod No | Özellikler | Koli Adedi | Fiyat |
|-----------|------------|------------|---------|
| 5616 2121 | 15W 3000K | 30 | 9,90 \$ |
| 5616 2141 | 15W 4000K | 30 | 9,90 \$ |
| 5616 2131 | 15W 6500K | 30 | 9,90 \$ |

Sırma 18W



IP 40

| Kod No | Özellikler | Koli Adedi | Fiyat |
|-----------|------------|------------|----------|
| 5616 2171 | 18W 3000K | 30 | 10,40 \$ |
| 5616 2151 | 18W 4000K | 30 | 10,40 \$ |
| 5616 2161 | 18W 6500K | 30 | 10,40 \$ |

Sırma 24W

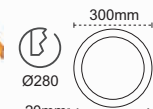

IP 40

| Kod No | Özellikler | Koli Adedi | Fiyat |
|-----------|------------|------------|----------|
| 5616 2271 | 24W 3000K | 20 | 23,55 \$ |
| 5616 2261 | 24W 4000K | 20 | 23,55 \$ |
| 5616 2251 | 24W 6500K | 20 | 23,55 \$ |

Opsiyon Farkları



| Kod No | Özellikler | Koli Adedi | Fiyat |
|-----------|--|------------|----------|
| 5913 1470 | Slim Downlight Acil Ayd. Kiti | 1 | 29,00 \$ |
| 5918 1847 | Triac DIM Driver (12W Slim Downlight için) | 1 | 18,90 \$ |
| 5918 1848 | Triac DIM Driver (15W Slim Downlight için) | 1 | 18,90 \$ |
| 5918 1849 | Triac DIM Driver (18W Slim Downlight için) | 1 | 20,90 \$ |

Sırma



**Yuvarlak ve Kare
Gövde Seçeneği**

Üstelik TSE Belgeli!

- 1W=1W çeker
- Pelsan Sırma S.Ü. LED Downlightlar beyan ettiği güç ve lümeni verir.
- Alüminyum gövde, alüminyum çerçeve
- 3 saate kadar acil aydınlatma ünite opsiyonu
- Triac ve 1-10V Dim Opsiyonu

Sırma S.Ü. 18W Yuvarlak

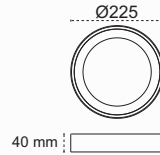

IP 20 ☺

| Kod no | Özellikler | Koli Adedi | Fiyat |
|-----------|------------|------------|----------|
| 5616 1441 | 18W 4000K | 20 | 21,20 \$ |
| 5616 1451 | 18W 6500K | 20 | 21,20 \$ |

Sırma S.Ü. 18W Kare

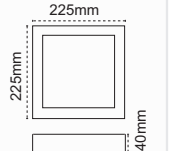

IP 20 ☺

| Kod no | Özellikler | Koli Adedi | Fiyat |
|-----------|------------|------------|----------|
| 5616 1461 | 18W 4000K | 20 | 21,20 \$ |
| 5616 1471 | 18W 6500K | 20 | 21,20 \$ |

Sırma S.Ü. 18W Yuvarlak Radar Sensörlü & Acil Aydınlatma Kitli

**Yeni
Ürün**

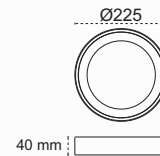

IP 20 ☺

| Kod No | Özellikler | Koli Adedi | Fiyat |
|-----------|---|------------|-----------|
| 5616 1453 | 18W 4000 / 6500K Radar Sensörlü | 20 | 33,45 \$ |
| 5616 1454 | 18W 4000 / 6500K EU Kit Acil | 20 | 96,40 \$ |
| 5616 1455 | 18W 4000 / 6500K Radar Sensörlü + EU Kit Acil | 20 | 108,50 \$ |

Sırma S.Ü. 18W Kare Radar Sensörlü & Acil Aydınlatma Kitli

**Yeni
Ürün**

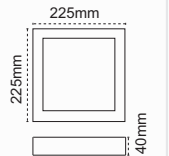

IP 20 ☺

| Kod No | Özellikler | Koli Adedi | Fiyat |
|-----------|---|------------|-----------|
| 5616 1473 | 18W 4000 / 6500K Radar Sensörlü | 20 | 33,45 \$ |
| 5616 1474 | 18W 4000 / 6500K EU Kit Acil | 20 | 96,40 \$ |
| 5616 1475 | 18W 4000 / 6500K Radar Sensörlü + EU Kit Acil | 20 | 108,50 \$ |

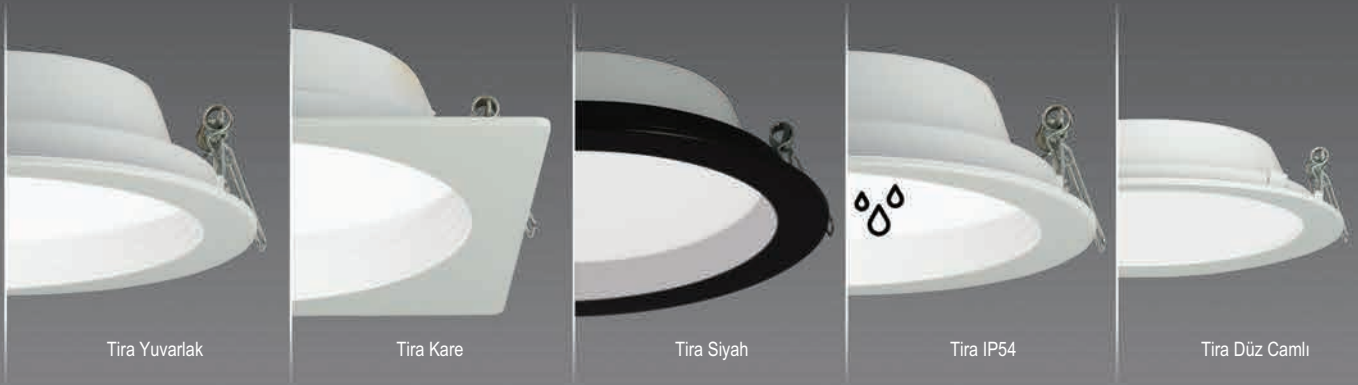

Ofis, İş Yeri, Mağaza ve Binanıza Uygun Bir Tira Armatür Mutlaka Vardır!



- 15-20-23,5 cm gövde çapı seçeneği
- Her gövde seçeneği için 3 çeşit güç opsiyonu
- İstenilen renk sıcaklığı uygulama opsiyonu
- Mat siyah ve beyaz çerçeve renk seçeneği
- Avrupa LED çip ve driver
- 3 saate kadar acil aydınlatma ünite opsiyonu
- DALI Dim opsiyonu

Tira Ø İçten Camlı

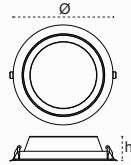

| Øxhmm |
|----------------|
| 7W : 148x56,5 |
| 10W : 148x56,5 |
| 15W : 197x56,5 |
| 20W : 197x56,5 |
| 25W : 233x56,5 |
| 35W : 233x56,5 |

| Kod No | Özellikler | ▣ (mm) | Koli Adedi | Fiyat |
|-----------|----------------------|--------|------------|----------|
| 5616 7511 | 5W 3000/4000K/6500K | 132 | 20 | 27,00 \$ |
| 5616 7521 | 7W 3000/4000K/6500K | 132 | 20 | 28,00 \$ |
| 5616 7531 | 9W 3000/4000K/6500K | 132 | 20 | 29,00 \$ |
| 5616 7541 | 10W 3000/4000K/6500K | 185 | 15 | 35,20 \$ |
| 5616 7551 | 15W 3000/4000K/6500K | 185 | 15 | 36,20 \$ |
| 5616 7561 | 20W 3000/4000K/6500K | 185 | 15 | 37,20 \$ |
| 5616 7571 | 20W 3000/4000K/6500K | 220 | 10 | 49,70 \$ |
| 5616 7581 | 25W 3000/4000K/6500K | 220 | 10 | 55,80 \$ |
| 5616 7591 | 35W 3000/4000K/6500K | 220 | 10 | 59,90 \$ |

Tira ∇ İçten Camlı

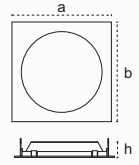
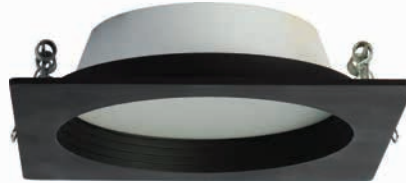

| a x b x h mm |
|--------------------|
| 7W : 148x148x56,5 |
| 10W : 148x148x56,5 |
| 15W : 197x197x56,5 |
| 20W : 197x197x56,5 |
| 25W : 233x233x56,5 |
| 35W : 233x233x56,5 |

| Kod No | Özellikler | ▣ (mm) | Koli Adedi | Fiyat |
|-----------|----------------------|--------|------------|----------|
| 5616 7611 | 5W 3000/4000K/6500K | 132 | 20 | 27,00 \$ |
| 5616 7621 | 7W 3000/4000K/6500K | 132 | 20 | 28,00 \$ |
| 5616 7631 | 9W 3000/4000K/6500K | 132 | 20 | 29,00 \$ |
| 5616 7641 | 10W 3000/4000K/6500K | 185 | 15 | 35,20 \$ |
| 5616 7651 | 15W 3000/4000K/6500K | 185 | 15 | 36,20 \$ |
| 5616 7661 | 20W 3000/4000K/6500K | 185 | 15 | 37,20 \$ |
| 5616 7671 | 20W 3000/4000K/6500K | 220 | 10 | 49,70 \$ |
| 5616 7681 | 25W 3000/4000K/6500K | 220 | 10 | 55,80 \$ |
| 5616 7691 | 35W 3000/4000K/6500K | 220 | 10 | 59,90 \$ |

Tira Ø Hemyüz

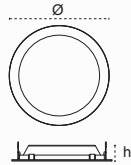

| Øxhmm |
|--------------|
| 10W : 190x50 |
| 15W : 190x50 |
| 20W : 240x50 |
| 25W : 240x50 |
| 35W : 240x50 |

| Kod No | Özellikler | ▣ (mm) | Koli Adedi | Fiyat |
|-----------|----------------------|--------|------------|----------|
| 5616 8141 | 10W 3000/4000K/6500K | 185 | 15 | 33,10 \$ |
| 5616 8151 | 15W 3000/4000K/6500K | 185 | 15 | 34,10 \$ |
| 5616 8161 | 20W 3000/4000K/6500K | 185 | 15 | 35,10 \$ |
| 5616 8171 | 20W 3000/4000K/6500K | 225 | 10 | 47,80 \$ |
| 5616 8181 | 25W 3000/4000K/6500K | 225 | 10 | 53,90 \$ |
| 5616 8191 | 35W 3000/4000K/6500K | 225 | 10 | 58,00 \$ |

Tira IP54

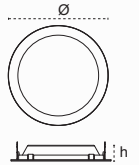

| Øxhmm |
|----------------|
| 7W : 148x56,5 |
| 10W : 148x56,5 |
| 15W : 197x56,5 |
| 20W : 197x56,5 |
| 25W : 240x56,5 |
| 35W : 240x56,5 |

| Kod No | Özellikler | ▣ (mm) | Koli Adedi | Fiyat |
|-----------|---------------------------|--------|------------|----------|
| 5616 8011 | 7W IP54 3000/4000K/6500K | 132 | 20 | 34,20 \$ |
| 5616 8021 | 9W IP54 3000/4000K/6500K | 132 | 20 | 35,20 \$ |
| 5616 8031 | 15W IP54 3000/4000K/6500K | 185 | 15 | 48,80 \$ |
| 5616 8041 | 20W IP54 3000/4000K/6500K | 185 | 15 | 50,20 \$ |
| 5616 8051 | 25W IP54 3000/4000K/6500K | 220 | 10 | 66,90 \$ |
| 5616 8061 | 35W IP54 3000/4000K/6500K | 220 | 10 | 68,80 \$ |

Opsiyon Farkları

| Kod No | Özellikler | Koli Adedi | Fiyat |
|-----------|---------------------------|------------|----------|
| 5913 1470 | Tira Acil Aydınlatma Kiti | 1 | 29,00 \$ |

Tira 150mm Ø İçten Camlı

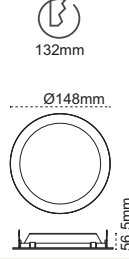

IP 40 ☉

| Kod No | Özellikler | Koli Adedi | Fiyat |
|-----------|--------------------|------------|----------|
| 5616 7111 | 5W 3000/4000/6500K | 20 | 24,90 \$ |
| 5616 7121 | 7W 3000/4000/6500K | 20 | 25,90 \$ |
| 5616 7131 | 9W 3000/4000/6500K | 20 | 26,90 \$ |

Tira 150mm Ø İçten Camlı

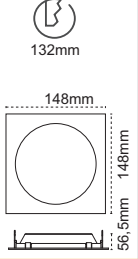

IP 40 ☉

| Kod No | Özellikler | Koli Adedi | Fiyat |
|-----------|--------------------|------------|----------|
| 5616 7211 | 5W 3000/4000/6500K | 20 | 24,90 \$ |
| 5616 7221 | 7W 3000/4000/6500K | 20 | 25,90 \$ |
| 5616 7231 | 9W 3000/4000/6500K | 20 | 26,90 \$ |

Tira 200mm Ø İçten Camlı

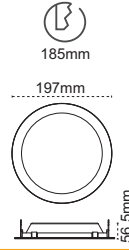

IP 40 ☉

| Kod No | Özellikler | Koli Adedi | Fiyat |
|-----------|---------------------|------------|----------|
| 5616 7141 | 10W 3000/4000/6500K | 15 | 33,10 \$ |
| 5616 7151 | 15W 3000/4000/6500K | 15 | 34,20 \$ |
| 5616 7161 | 20W 3000/4000/6500K | 15 | 35,20 \$ |

Tira 200mm Ø İçten Camlı

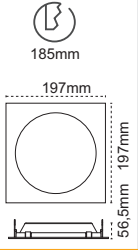

IP 40 ☉

| Kod No | Özellikler | Koli Adedi | Fiyat |
|-----------|---------------------|------------|----------|
| 5616 7241 | 10W 3000/4000/6500K | 15 | 33,10 \$ |
| 5616 7251 | 15W 3000/4000/6500K | 15 | 34,20 \$ |
| 5616 7261 | 20W 3000/4000/6500K | 15 | 35,20 \$ |

Tira 230mm Ø İçten Camlı

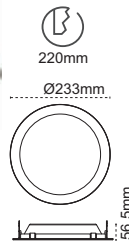

IP 40 ☉

| Kod No | Özellikler | Koli Adedi | Fiyat |
|-----------|---------------------|------------|----------|
| 5616 7171 | 20W 3000/4000/6500K | 10 | 47,80 \$ |
| 5616 7181 | 25W 3000/4000/6500K | 10 | 53,90 \$ |
| 5616 7191 | 35W 3000/4000/6500K | 10 | 58,00 \$ |

Tira 230mm Ø İçten Camlı

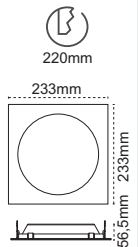

IP 40 ☉

| Kod No | Özellikler | Koli Adedi | Fiyat |
|-----------|---------------------|------------|----------|
| 5616 7271 | 20W 3000/4000/6500K | 10 | 47,80 \$ |
| 5616 7281 | 25W 3000/4000/6500K | 10 | 53,90 \$ |
| 5616 7291 | 35W 3000/4000/6500K | 10 | 58,00 \$ |

Opsiyon Farkları

| Kod No | Özellikler | Koli Adedi | Fiyat |
|-----------|---------------------------|------------|----------|
| 5913 1470 | Tira Acil Aydınlatma Kiti | 1 | 29,00 \$ |

Plüton Beyaz



IP 40

| Kod No | Özellikler | Koli Adedi | Fiyat |
|-----------|------------------|------------|---------|
| 5616 1921 | 5W COB LED 6500K | 100 | 4,55 \$ |
| 5616 1971 | 5W COB LED 3000K | 100 | 4,55 \$ |

Plüton Saten



IP 40

| Kod No | Özellikler | Koli Adedi | Fiyat |
|-----------|------------------|------------|---------|
| 5616 1981 | 5W COB LED 6500K | 100 | 4,55 \$ |
| 5616 1901 | 5W COB LED 3000K | 100 | 4,55 \$ |

Plüton Krom



IP 40

| Kod No | Özellikler | Koli Adedi | Fiyat |
|-----------|------------------|------------|---------|
| 5616 1941 | 5W COB LED 6500K | 100 | 4,55 \$ |
| 5616 1961 | 5W COB LED 3000K | 100 | 4,55 \$ |

Sirius Simetrik

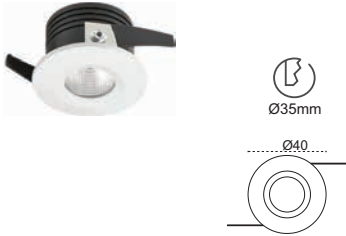

IP 40

| Kod No | Özellikler | Koli Adedi | Fiyat |
|-----------|---------------------------|------------|---------|
| 5616 1651 | 3W COB LED Simetrik 4000K | 100 | 6,70 \$ |

Sirius Asimetrik



IP 40

| Kod No | Özellikler | Koli Adedi | Fiyat |
|-----------|----------------------------|------------|----------|
| 5616 1661 | 3W COB LED Asimetrik 4000K | 50 | 18,20 \$ |

Sirius Kristal



IP 40

| Kod No | Özellikler | Koli Adedi | Fiyat |
|-----------|------------------|------------|---------|
| 5616 1671 | 2W COB LED 4000K | 20 | 7,60 \$ |

Libra Spot Mesh Tavan

Yeni Ürün

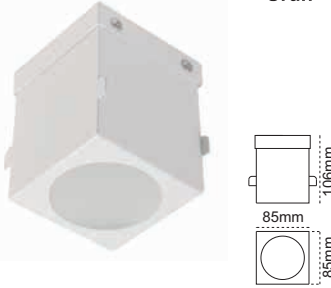

IP 40

| Kod No | Özellikler | Koli Adedi | Fiyat |
|-----------|-------------------|------------|----------|
| 5615 5051 | 5W LED S.A. 4000K | 20 | 43,25 \$ |

Nira Beyaz



IP 40

| Kod No | Özellikler | Koli Adedi | Fiyat |
|-----------|-------------------------|------------|----------|
| 5616 2401 | 30W COB LED 4000K-Beyaz | 12 | 65,00 \$ |

Nira Siyah

Yeni Ürün



IP 40

| Kod No | Özellikler | Koli Adedi | Fiyat |
|-----------|-------------------------|------------|----------|
| 5816 5750 | 30W COB LED 4000K-Siyah | 12 | 65,00 \$ |

Cora 19 20W

165x165mm

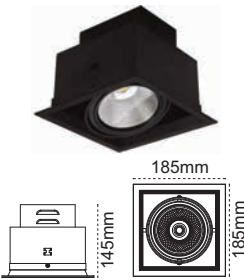

IP 40

| Kod No | Özellikler | Koli Adedi | Fiyat |
|-----------|-------------------|------------|----------|
| 5816 5310 | 20W COB LED 4000K | 8 | 40,00 \$ |

Cora 19 2X20W

315x165mm

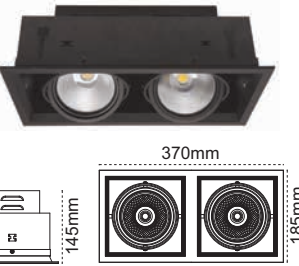

IP 40

| Kod No | Özellikler | Koli Adedi | Fiyat |
|-----------|---------------------|------------|----------|
| 5816 5320 | 2X20W COB LED 4000K | 4 | 77,00 \$ |

Cora 19 3X20W

465x165mm

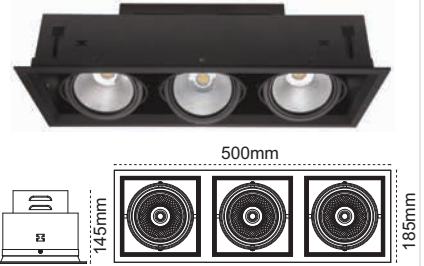

IP 40

| Kod No | Özellikler | Koli Adedi | Fiyat |
|-----------|---------------------|------------|-----------|
| 5816 5330 | 3X20W COB LED 4000K | 4 | 103,00 \$ |



Mağazalarda Şık ve Dekoratif Aydınlatma

Seta



Yeni
Ürün

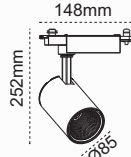

IP 40

| Kod No | Özellikler | Koli Adedi | Fiyat |
|-----------|-------------------|------------|----------|
| 5816 5410 | 30W COB LED 3000K | 12 | 40,00 \$ |
| 5816 5420 | 30W COB LED 4000K | 12 | 40,00 \$ |

Mila



Yeni
Ürün

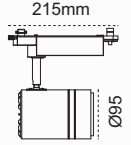

IP 40

| Kod No | Özellikler | Koli Adedi | Fiyat |
|-----------|-------------------|------------|----------|
| 5816 5450 | 40W COB LED 3000K | 12 | 80,00 \$ |
| 5816 5460 | 40W COB LED 4000K | 12 | 80,00 \$ |

Theta

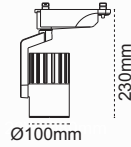

IP 40

| Kod No | Özellikler | Koli Adedi | Fiyat |
|-----------|-------------------|------------|----------|
| 5816 5240 | 30W COB LED 3000K | 16 | 40,00 \$ |
| 5816 5220 | 30W COB LED 4000K | 16 | 40,00 \$ |

Lampda

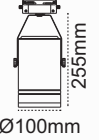

IP 40

| Kod No | Özellikler | Koli Adedi | Fiyat |
|-----------|-------------------|------------|----------|
| 5816 5140 | 30W COB LED 3000K | 24 | 40,00 \$ |
| 5816 5120 | 30W COB LED 4000K | 24 | 40,00 \$ |

Ray ve Aksesuarları (Monofaze)

| Kod No | Özellikler | Koli Adedi | Fiyat | Kod No | Özellikler | Koli Adedi | Fiyat | Kod No | Özellikler | Koli Adedi | Fiyat |
|----------|------------------|------------|---------|----------|--------------------|------------|---------|----------|-----------------------|------------|----------|
| 3110 356 | I Birleşim Beyaz | 1 | 2,50 \$ | 3110 355 | T Birleşim Beyaz | 1 | 5,20 \$ | 3110 351 | Monofaze Ray Beyaz 1m | 1 | 6,50 \$ |
| 3110 339 | I Birleşim Siyah | 1 | 2,50 \$ | 3110 365 | T Birleşim Siyah | 1 | 5,20 \$ | 3110 352 | Monofaze Ray Beyaz 2m | 1 | 13,00 \$ |
| 3110 354 | L Birleşim Beyaz | 1 | 3,50 \$ | 3110 312 | Ray Adaptörü Beyaz | 1 | 2,25 \$ | 3110 353 | Monofaze Ray Beyaz 3m | 1 | 19,50 \$ |
| 3110 364 | L Birleşim Siyah | 1 | 3,50 \$ | 3110 310 | Ray Adaptörü Siyah | 1 | 2,25 \$ | 3110 361 | Monofaze Ray Siyah 1m | 1 | 6,50 \$ |
| | | | | | | | | 3110 362 | Monofaze Ray Siyah 2m | 1 | 13,00 \$ |
| | | | | | | | | 3110 335 | Monofaze Ray Siyah 3m | 1 | 19,50 \$ |

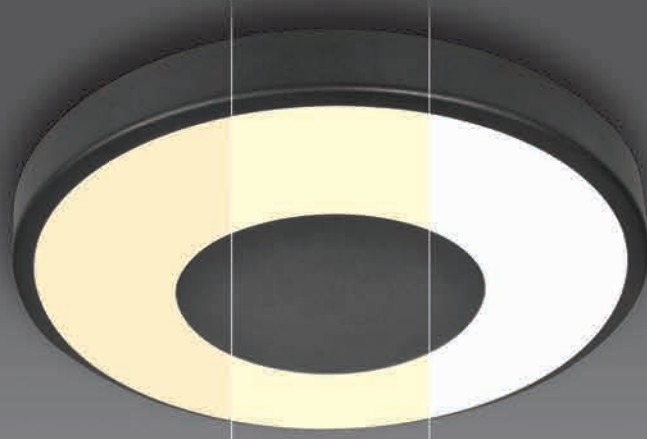

**Günün Her Saatine
Özel Dinamik Çözümler**

3000K
Akşam

4000K
Öğle

6500K
Sabah

**3 Farklı Kademedede
3 Farklı Renk Sıcaklığı**

Picto Dinamik Beyaz

Yeni
Ürün



IP40

| Kod No | Özellikler | Koli Adedi | Fiyat |
|-----------|------------------------------|------------|----------|
| 5613 1481 | 2x24W Kare Dinamik Beyaz | 10 | 53,60 \$ |
| 5613 1491 | 2x24W Yuvarlak Dinamik Beyaz | 10 | 53,60 \$ |

Punto Dinamik Beyaz

Yeni
Ürün



IP 40

| Kod No | Özellikler | Koli Adedi | Fiyat |
|-----------|------------------------------|------------|----------|
| 5613 1581 | 2x24W Kare Dinamik Beyaz | 10 | 53,60 \$ |
| 5613 1591 | 2x24W Yuvarlak Dinamik Beyaz | 10 | 53,60 \$ |

Picto

Yeni
Ürün



IP 40

| Kod No | Özellikler | Koli Adedi | Fiyat |
|-----------|----------------------------|------------|----------|
| 5613 1431 | 24W Kare 4000K / 6500K | 10 | 31,40 \$ |
| 5613 1441 | 24W Yuvarlak 4000K / 6500K | 10 | 31,40 \$ |

Punto

Yeni
Ürün



IP 40

| Kod No | Özellikler | Koli Adedi | Fiyat |
|-----------|----------------------------|------------|----------|
| 5613 1531 | 24W Kare 4000K / 6500K | 10 | 31,40 \$ |
| 5613 1541 | 24W Yuvarlak 4000K / 6500K | 10 | 31,40 \$ |

Pio 35cm Yeni Ürün



Ø350mm



IP 40

| Kod No | Özellikler | Koli Adedi | Fiyat |
|-----------|-----------------------------|------------|----------|
| 5613 1341 | Pio LED 24W 6500K | 10 | 24,00 \$ |
| 5613 1391 | Pio LED 2x24W Dinamik Beyaz | 10 | 46,20 \$ |

Pio 35X35cm Yeni Ürün



Ø350mm



IP 40

| Kod No | Özellikler | Koli Adedi | Fiyat |
|-----------|-----------------------------|------------|----------|
| 5613 1331 | Pio LED 24W 6500K | 10 | 24,00 \$ |
| 5613 1381 | Pio LED 2x24W Dinamik Beyaz | 10 | 46,20 \$ |

Opal 35cm



Ø350mm



IP 40

| Kod No | Özellikler | Koli Adedi | Fiyat |
|-----------|--------------------|------------|----------|
| 5613 1131 | Opal LED 23W 6500K | 16 | 24,50 \$ |

Pio 25cm



Ø250mm



IP 40

| Kod No | Özellikler | Koli Adedi | Fiyat |
|-----------|-------------------|------------|----------|
| 5613 1371 | Pio LED 12W 6500K | 10 | 15,00 \$ |

Pio 25X25cm



Ø250mm



IP 40

| Kod No | Özellikler | Koli Adedi | Fiyat |
|-----------|-------------------|------------|----------|
| 5613 1321 | Pio LED 12W 6500K | 10 | 15,00 \$ |

Opal 35x35cm



Ø350mm



IP 40

| Kod No | Özellikler | Koli Adedi | Fiyat |
|-----------|--------------------|------------|----------|
| 5613 1161 | Opal LED 23W 6500K | 16 | 24,50 \$ |

Planet



Ø460mm



IP 40

| Kod No | Özellikler | Koli Adedi | Fiyat |
|-----------|----------------------|------------|----------|
| 5610 3011 | Planet LED 23W 6500K | 6 | 47,00 \$ |

Popart



Ø410mm



IP 40

| Kod No | Özellikler | Koli Adedi | Fiyat |
|-----------|----------------------|------------|----------|
| 5610 4011 | Popart LED 23W 6500K | 6 | 47,00 \$ |

Cemre



Ø340mm



IP 40

| Kod No | Özellikler | Koli Adedi | Fiyat |
|-----------|---------------------|------------|----------|
| 5613 1011 | Cemre LED 23W 6500K | 10 | 18,90 \$ |

İlkbahar



Ø410mm



IP 40

| Kod No | Özellikler | Koli Adedi | Fiyat |
|-----------|------------------------|------------|----------|
| 5613 1101 | İlkbahar LED 23W 6500K | 10 | 18,90 \$ |

Sipahi



Ø232mm



IP 40

| Kod No | Özellikler | Koli Adedi | Fiyat |
|-----------|------------|------------|---------|
| 5413 1030 | Sipahi E27 | 24 | 3,20 \$ |

Samsun



Ø232mm



IP 40

| Kod No | Özellikler | Koli Adedi | Fiyat |
|-----------|------------|------------|---------|
| 5413 1100 | Samsun E27 | 24 | 3,50 \$ |

Pelsan IP44 Tavan & Duvar Armatürleri

IP44 Oval Kafes 21 Alüminyum Enjeksiyon

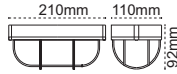

IP 44

Kod No Özellikler
5730 6050 Oval Kafes 21 Gri E27

Koli Adedi Fiyat
18 7,70 \$

IP44 Oval Kafes 28 Alüminyum Enjeksiyon

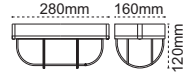

IP 44

Kod No Özellikler
5730 6120 Oval Kafes 28 Gri E27

Koli Adedi Fiyat
12 12,60 \$

IP44 Yaka 20 Alüminyum Enjeksiyon

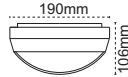

IP 44

Kod No Özellikler
5730 5130 Yaka 20 Gri E27

Koli Adedi Fiyat
18 10,80 \$

IP44 Yaka 26 Alüminyum Enjeksiyon

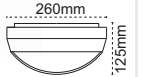

IP 44

Kod No Özellikler
5730 5180 Yaka 26 Gri E27

Koli Adedi Fiyat
6 15,75 \$

Armada Alüminyum Enjeksiyon

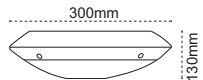

IP 44

Kod No Özellikler
5812 6710 Armada Aplik

Koli Adedi Fiyat
8 13,10 \$

IP44 Polo2 Alüminyum Enjeksiyon

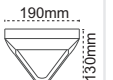

IP 44

Kod No Özellikler
5730 5510 Polo 2 Gri E27

Koli Adedi Fiyat
8 18,90 \$

Toz ve Su Almaz



Havana IP66

- Pelsan Havana tavan armatürü IP66 koruma sınıfı ile çevre şartlarından etkilenmez.
- Darbe dayanımı yüksektir. Kırılmaz.
- E27, LED, LED radar sensörlü, LED acil aydınlatma kitli opsiyonları vardır.
- Paslanmaz vida ve UV ışınları ile sararmaz opal cama sahiptir.

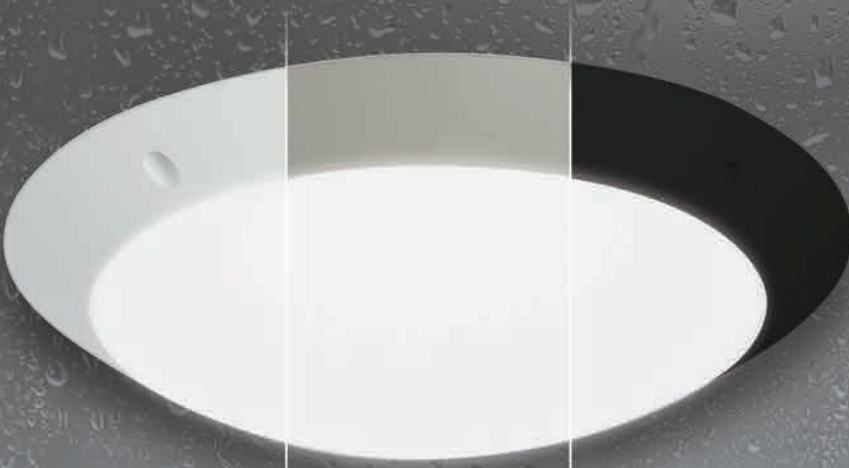

Havana IP66 Gri

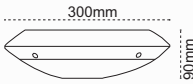

| Kod No | Özellikler | Koli Adedi | Fiyat |
|-----------|-------------------------|------------|----------|
| 5610 6610 | E27 max 23W | 8 | 13,10 \$ |
| 5610 6640 | 2xE27 | 8 | 14,10 \$ |
| 5610 6620 | 15W LED | 8 | 28,30 \$ |
| 5610 6630 | 15W LED Radar Sens. | 8 | 47,10 \$ |
| 5610 6624 | 15W LED Acil Ayd. Kitli | 8 | 56,60 \$ |

Havana IP66 Beyaz

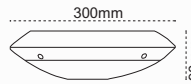

| Kod No | Özellikler | Koli Adedi | Fiyat |
|-----------|-------------------------|------------|----------|
| 5610 6612 | E27 max 23W | 8 | 13,10 \$ |
| 5610 6642 | 2xE27 | 8 | 14,10 \$ |
| 5610 6621 | 15W LED | 8 | 28,30 \$ |
| 5610 6631 | 15W LED Radar Sens. | 8 | 47,10 \$ |
| 5610 6625 | 15W LED Acil Ayd. Kitli | 8 | 56,60 \$ |

Havana IP66 Siyah

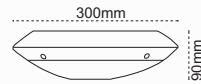

| Kod No | Özellikler | Koli Adedi | Fiyat |
|-----------|-------------------------|------------|----------|
| 5610 6611 | E27 max 23W | 8 | 13,10 \$ |
| 5610 6641 | 2xE27 | 8 | 14,10 \$ |
| 5610 6622 | 15W LED | 8 | 28,30 \$ |
| 5610 6632 | 15W LED Radar Sens. | 8 | 47,10 \$ |
| 5610 6626 | 15W LED Acil Ayd. Kitli | 8 | 56,60 \$ |

Renk Opsiyonları

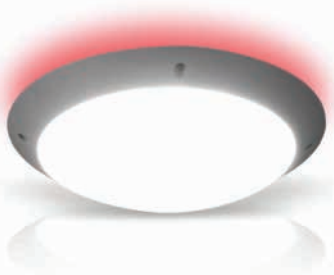

Gri /Kırmızı

| Kod No | Özellikler | Koli Adedi | Fiyat |
|-----------|-------------|------------|----------|
| 5610 6613 | E27 max 23W | 8 | 15,00 \$ |



Gri /Turuncu

| Kod No | Özellikler | Koli Adedi | Fiyat |
|-----------|-------------|------------|----------|
| 5610 6615 | E27 max 23W | 8 | 15,00 \$ |



Gri /Mavi

| Kod No | Özellikler | Koli Adedi | Fiyat |
|-----------|-------------|------------|----------|
| 5610 6614 | E27 max 23W | 8 | 15,00 \$ |

360° Hareket Sensörü

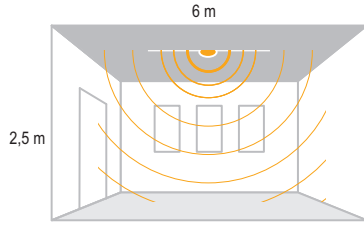

3 gözlü teknoloji ile çok geniş bir alanı tarayarak her yönden algılama yapar.

IP 20

| Kod No | Özellikler | Koli Adedi | Fiyat |
|-----------|----------------------------|------------|---------|
| 5513 5110 | 360 Derece Hareket Sensörü | 50 | 7,85 \$ |

180° Hareket Sensörü

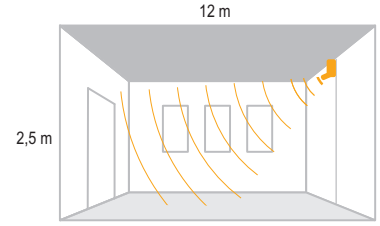

IP 20

| Kod No | Özellikler | Koli Adedi | Fiyat |
|-----------|----------------------------|------------|---------|
| 5513 5010 | 180 Derece Hareket Sensörü | 50 | 7,35 \$ |

Mini Hareket Sensörü

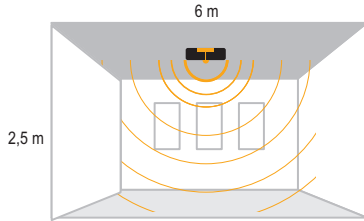

Sensör uygulama alanında karşılaşılan mekanik yerleşim sorunlarını gidemek için pratik kullanım sağlar.

IP 20

| Kod No | Özellikler | Koli Adedi | Fiyat |
|-----------|----------------------|------------|---------|
| 5513 5340 | Mini Hareket Sensörü | 100 | 7,35 \$ |

Radar Sensör

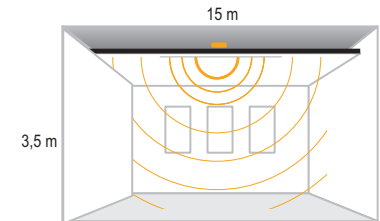

Sıva altı, gizli, armatür içi ve dışı uygulamalarda en iyi çözüm.

IP 20

| Kod No | Özellikler | Koli Adedi | Fiyat |
|-----------|--------------|------------|----------|
| 5513 5220 | Radar Sensör | 100 | 12,25 \$ |

Sıva Altı Tavan Sensör

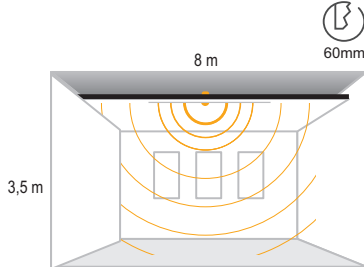

Zaman, Lux ve mesafe ayarlama özelliği ile sıva altı uygulamalar için ideal çözüm

IP 20

| Kod No | Özellikler | Koli Adedi | Fiyat |
|-----------|------------------------|------------|---------|
| 5513 5230 | Sıva Altı Tavan Sensör | 50 | 8,90 \$ |

Sıva Altı Tavan Sensör Küçük

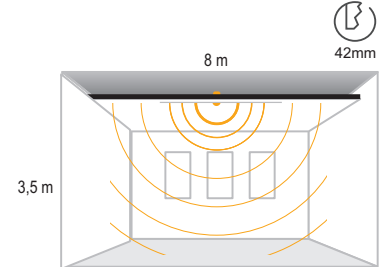

Zaman, Lux ve mesafe ayarlama özelliği ile sıva altı uygulamalar için ideal çözüm

IP 20

| Kod No | Özellikler | Koli Adedi | Fiyat |
|-----------|------------------------------|------------|---------|
| 5513 5330 | Sıva Altı Tavan Sensör Küçük | 100 | 8,90 \$ |

IP65 Sensör Kutusu



Dış mekanlarda kolaylıkla sensör kullanmanızı sağlar.

IP 65

| Kod No | Özellikler | Koli Adedi | Fiyat |
|-----------|--------------------|------------|---------|
| 5513 5390 | IP65 Sensör Kutusu | 50 | 9,00 \$ |

Fotosel



Gece gündüz farkını algılayarak dış mekan aydınlatmalarında kontrol sağlar.

IP 65

| Kod No | Özellikler | Koli Adedi | Fiyat |
|-----------|------------|------------|---------|
| 5513 5550 | Fotosel | 100 | 4,70 \$ |

Varlık Sensörü

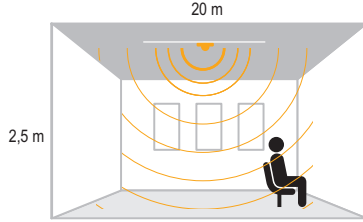

Ortamdaki kişiye duyarlı olarak aydınlatma kontrolü sağlar.

IP 20

| Kod No | Özellikler | Koli Adedi | Fiyat |
|-----------|----------------|------------|----------|
| 5513 5350 | Varlık Sensörü | 50 | 20,00 \$ |

Dört Yönlü Hareket Sensörü

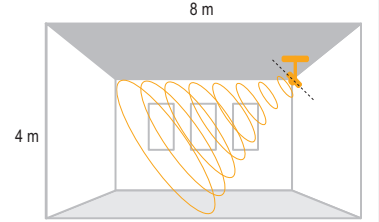

Özellikle kör nokta algılamaları için ayarlanabilir başlığı sayesinde hassas algılama yapar.

IP 20

| Kod No | Özellikler | Koli Adedi | Fiyat |
|-----------|----------------------------|------------|----------|
| 5513 5310 | Dört Yönlü Hareket Sensörü | 100 | 12,00 \$ |

İç Sensör

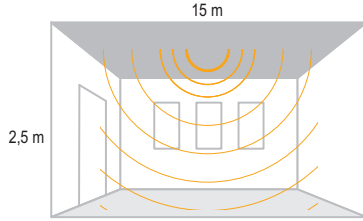

IP 20

| Kod No | Özellikler | Koli Adedi | Fiyat |
|-----------|------------|------------|---------|
| 5513 5210 | İç Sensör | 100 | 9,30 \$ |

Yüksek Tavan Sensörü

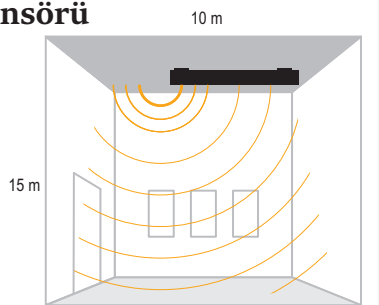

4-15 mt arası yüksekliklerde hassas algılama yapan yüksek tavan sensörü ile Lux, mesafe ve zaman ayarı yapılabilir.

IP 20

| Kod No | Özellikler | Koli Adedi | Fiyat |
|-----------|----------------------|------------|----------|
| 5513 5320 | Yüksek Tavan Sensörü | 50 | 28,50 \$ |

Duyulu Hareket Sensörü

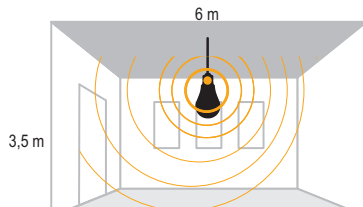

E27 duyu uygunluğu ile lambalarda kontrol sağlar.

IP 20

| Kod No | Özellikler | Koli Adedi | Fiyat |
|-----------|------------------------|------------|---------|
| 5513 5150 | Duyulu Hareket Sensörü | 50 | 9,25 \$ |

Anahtar Sensör

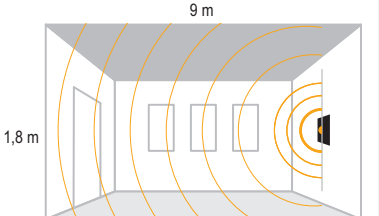

Duvar tipi uygulamalarda anahtara ihtiyaç duymadan, sensör algılaması ile çalışır.

IP 20

| Kod No | Özellikler | Koli Adedi | Fiyat |
|-----------|----------------|------------|---------|
| 5513 5170 | Anahtar Sensör | 50 | 8,90 \$ |

İç Sensör + LED Driver (15W)

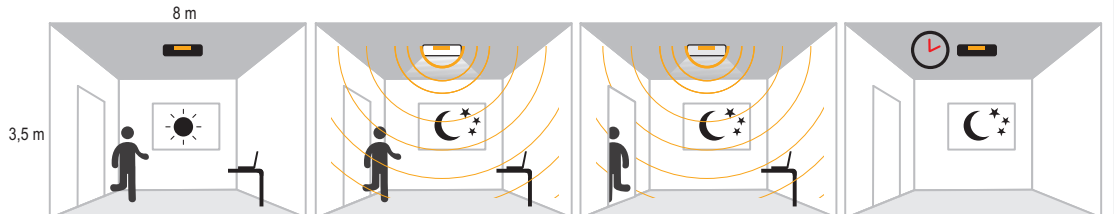

Sürücü ünitesi ile birleşik, multifonksiyonel aydınlatma kontrolü. Gün ışığı sensörü ile radar teknolojisini bir arada kullanarak maksimum verimliliği yakalayın.

Gün ışığında çalışmaz.

5 Lux altında harekete duyarlı olarak çalışır.

5 Lux altında hareket durunca %20 seviyesine düşer.

5 Lux altında hareket durduktan 10 dakika sonra kapanır.

IP 20

| Kod No | Özellikler | Koli Adedi | Fiyat |
|-----------|---|------------|----------|
| 5513 5420 | Radar Sensörlü Dim Driver 27w (30-45V /DC 600 mA) | 50 | 28,00 \$ |
| 5513 5410 | Radar Sensörlü Dim Driver 15w (30-51V /DC 300 mA) | 50 | 25,00 \$ |

Sense

Işık Tam Zamanında Yansın!



- Time butonu ile lambanın ne kadar süreyle yanacağı,
- Sens butonu ile lambanın ne kadar mesafeden hareketi algılayıp yanacağı ayarlanabilir.
- (-) işareti yükün yalnızca gece (+) işareti gündüz ve gece açık olacağını belirtir.
- Max.montaj yüksekliği 4.5m'dir.

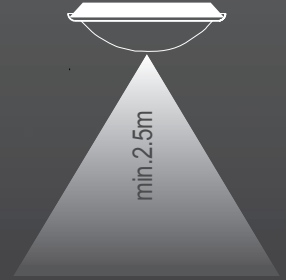

Sense Acil Sensörlü

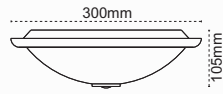

IP 20 ⊕

| Kod No | Özellikler | Koli Adedi | Fiyat |
|-----------|----------------------------|------------|----------|
| 5413 2113 | 2xE27 Sensörlü + Acil Ayd. | 8 | 28,50 \$ |

Senseled Sensörlü

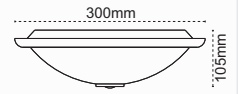

IP 20 ⊕

| Kod No | Özellikler | Koli Adedi | Fiyat |
|-----------|-----------------|------------|----------|
| 5413 2014 | 6W LED Sensörlü | 8 | 20,55 \$ |

Senseled Acil Sensörlü

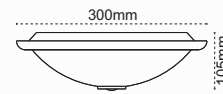

IP 20 ⊕

| Kod No | Özellikler | Koli Adedi | Fiyat |
|-----------|-----------------------------|------------|----------|
| 5413 2114 | 8W LED Sensörlü + Acil Ayd. | 8 | 31,50 \$ |

Sense & Sense Sensörlü

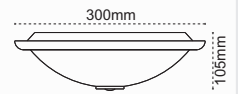

IP 20 ⊕

| Kod No | Özellikler | Koli Adedi | Fiyat |
|-----------|----------------------|------------|----------|
| 5413 2010 | 2xE27 Sense | 8 | 9,00 \$ |
| 5413 2011 | 2XE27 Sense Sensörlü | 8 | 11,70 \$ |

IP66 Havana Radar Sensörlü

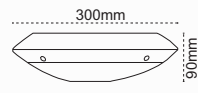

IP 66 ⊕

| Kod No | Özellikler | Koli Adedi | Fiyat |
|-----------|------------------------|------------|----------|
| 5610 6630 | 15W LED Radar Sensörlü | 8 | 47,10 \$ |

IP66 Havana Acil Aydınlatma Kitli

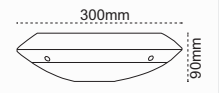

IP 66 ⊕

| Kod No | Özellikler | Koli Adedi | Fiyat |
|-----------|-------------------------------|------------|----------|
| 5610 6624 | 15W LED Acil Aydınlatma Kitli | 8 | 56,60 \$ |

Işığa Hareket Kazandırır

Multiline LED Linear Armatür

Multiline lineer armatür, mağaza, market, ofis ve depolarda ışığın istenen yönde iletilmesini sağlayan hareketli sistemi, modern endüstriyel tasarımı ile yönlendirilebilir lineer aydınlatma sağlar.

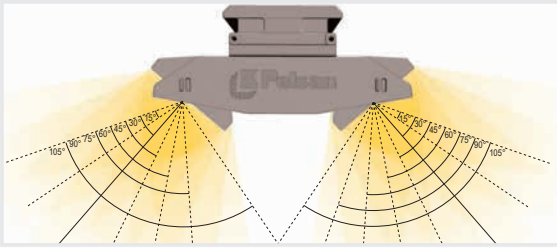
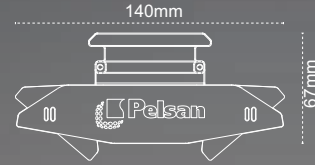

Işığı istediğiniz noktaya yönlendirir.
7 kademeli ayarlanabilir ışık açısı ile pratik bir şekilde istediğiniz yere ışığı yönlendirebilirsiniz. (15°- 105°)



Avrupa menşeli LED çip ve driver



120 lm/W verimlilik



Alüminyum gövde ile dayanıklı, estetik ve hafif



Sıva üstü veya sarkıt uygulaması



Kamaşma engelleyici özel difüzörü

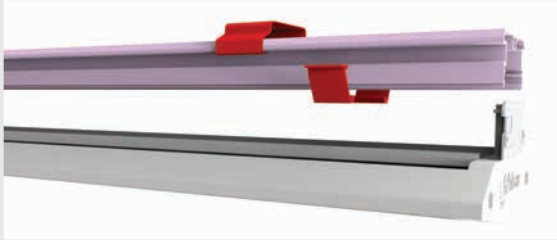

Kurulum kolaylığı sağlar.

2 parçadan oluşan Multiline LED lineer armatürü kolay ve güvenli bir şekilde monte edebilirsiniz.

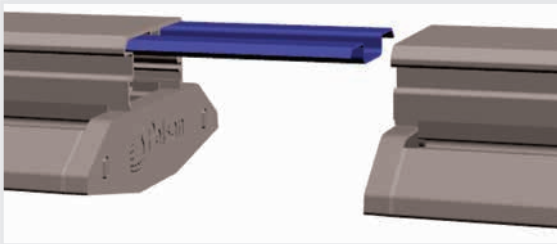

Sürekli lineer aydınlatma oluşturur.

Lineer bağlantı için tasarlanmış yan kapaklar ve bağlantı aparatı ile kesintisiz ışık imkanı verir.

Opsiyonlar

- Acil aydınlatma kiti (1-3 saat)
- DALI 1-10V Dim
- 120cm / 150cm boy
- 3000K-4000K-6500K
- Buzlu ve şeffaf cam

Multiline LED Linear Armatür



IP 40

| Kod No | Özellikler | Koli Adedi | Fiyat | Kod No | Özellikler | Koli Adedi | Fiyat |
|-----------|-------------------------------------|------------|-----------|-----------|--|------------|-----------|
| 5612 6111 | Multiline LED Linear Arm. 35W 120cm | 4 | 115,00 \$ | 5612 6121 | Multiline LED Linear Arm. 35W 120cm Kesintisiz Lineer Bağlantılı | 4 | 117,00 \$ |
| 5612 6151 | Multiline LED Linear Arm. 35W 150cm | 4 | 125,00 \$ | 5612 6171 | Multiline LED Linear Arm. 35W 150cm Kesintisiz Lineer Bağlantılı | 4 | 127,00 \$ |
| 5612 6161 | Multiline LED Linear Arm. 50W 150cm | 4 | 145,00 \$ | 5612 6181 | Multiline LED Linear Arm. 50W 150cm Kesintisiz Lineer Bağlantılı | 4 | 147,00 \$ |

Linea Large

Yeni Nesil Bant Armatür

- Sürekli ve homojen ışık
- İç mekan ve endüstriyel alanlarda kullanıma uygun

Linea Large LED

- Homojen ışık
- İç mekan ve endüstriyel alanlarda kullanıma uygun

IP 40

| Kod No | Özellikler | Koli Adedi | Fiyat |
|-----------|---------------------------------|------------|----------|
| 5610 2110 | Linea Large LED 18W 6500K 60cm | 20 | 15,60 \$ |
| 5610 2120 | Linea Large LED 36W 6500K 120cm | 20 | 23,40 \$ |
| 5610 2130 | Linea Large LED 18W 4000K 60cm | 20 | 15,60 \$ |
| 5610 2140 | Linea Large LED 36W 4000K 120cm | 20 | 23,40 \$ |



Linea LED

Aparatlar fiyata dahildir.
(Enerji kablosu, 15 cm esnek bağlantı aparatı, mini bağlantı aparatı, zemin montajı için gerekli klipsler, bitiş kapağı)

- Anahtarlı ve eklenebilir form
- Sürekli homojen ışık
- Bitiş kapağı sayesinde güvenli kurulum
- İç mekan ve endüstriyel alanlarda kullanıma uygun

IP 40

| Kod No | Özellikler | Koli Adedi | Fiyat |
|-----------|----------------------------|------------|----------|
| 5951 6260 | Linea LED 4W 6500K 30cm | 30 | 7,60 \$ |
| 5951 6270 | Linea LED 8W 6500K 60cm | 30 | 9,20 \$ |
| 5951 6280 | Linea LED 16W 6500K 120 cm | 30 | 19,50 \$ |
| 3515 301 | Linea LED Fiş Kablo | 150 | 1,90 \$ |



Linea LED IP65

- Homojen ışık
- Endüstriyel alanlarda kullanıma uygun

IP 65

| Kod No | Özellikler | Koli Adedi | Fiyat |
|-----------|---------------------------------|------------|----------|
| 5610 2190 | Linea IP65 LED 36W 4000K 120 cm | 10 | 24,90 \$ |
| 5610 2170 | Linea IP65 LED 36W 6500K 120 cm | 10 | 24,90 \$ |



Yeni Ürün

TMS LED Tüp





IP 20 

37mm
64mm

| Kod No | Özellikler | Koli Adedi | Fiyat |
|-----------|-------------------------|------------|---------|
| 5012 9420 | LED Tüp TMS Tekli 60cm | 12 | 5,10 \$ |
| 5012 9430 | LED Tüp TMS Tekli 120cm | 12 | 5,30 \$ |
| 5012 9440 | LED Tüp TMS Tekli 150cm | 12 | 8,50 \$ |
| 5012 9040 | LED Tüp TMS İkili 60cm | 6 | 5,60 \$ |
| 5012 9530 | LED Tüp TMS İkili 120cm | 6 | 6,80 \$ |
| 5012 9300 | LED Tüp TMS İkili 150cm | 6 | 9,00 \$ |

T8 TMS Floresan



IP 20 

37mm
64mm

| Kod No | Özellikler | Koli Adedi | Fiyat |
|-----------|-----------------------|------------|----------|
| 5012 9032 | 1x18W TMS T8 Floresan | 6 | 15,20 \$ |
| 5012 9042 | 2x18W TMS T8 Floresan | 6 | 15,60 \$ |
| 5012 9012 | 1x15W TMS T8 Floresan | 6 | 15,20 \$ |
| 5012 9062 | 1x30W TMS T8 Floresan | 6 | 15,60 \$ |
| 5012 9082 | 1x36W TMS T8 Floresan | 6 | 16,00 \$ |
| 5012 9092 | 2x36W TMS T8 Floresan | 6 | 20,00 \$ |
| 5012 9292 | 1x58W TMS T8 Floresan | 6 | 21,60 \$ |
| 5012 9302 | 2x58W TMS T8 Floresan | 6 | 24,60 \$ |

Market Armatürü LED Tüp



IP 20 

160mm
70mm

| Kod No | Özellikler | Koli Adedi | Fiyat |
|-----------|-------------------------------------|------------|----------|
| 5612 2511 | T8 Market Arm. LED Tüp 1x18W 120 cm | 5 | 34,90 \$ |
| 5612 2521 | T8 Market Arm. LED Tüp 1x24W 150 cm | 5 | 38,90 \$ |

T5 Market Armatürü



IP 20 

160mm
70mm

| Kod No | Özellikler | Koli Adedi | Fiyat |
|-----------|----------------------|------------|----------|
| 5612 2812 | 1x28W Elek. Bal. TL5 | 1 | 36,60 \$ |
| 5612 2822 | 2x28W Elek. Bal. TL5 | 1 | 39,90 \$ |
| 5612 2832 | 1x35W Elek. Bal. TL5 | 1 | 39,90 \$ |
| 5612 2842 | 2x35W Elek. Bal. TL5 | 1 | 43,20 \$ |
| 5612 2852 | 1x54W Elek. Bal. TL5 | 1 | 36,60 \$ |
| 5612 2862 | 2x54W Elek. Bal. TL5 | 1 | 39,90 \$ |
| 5612 2872 | 1x80W Elek. Bal. TL5 | 1 | 53,40 \$ |
| 5612 2882 | 2x80W Elek. Bal. TL5 | 1 | 56,80 \$ |

Etanj Duyulu Sac Bant LED Tüp



IP 20 

53mm
97mm

| Kod No | Özellikler | Koli Adedi | Fiyat |
|-----------|-------------|------------|----------|
| 5024 1210 | Tekli 60cm | 6 | 8,50 \$ |
| 5024 1220 | Tekli 120cm | 6 | 10,40 \$ |
| 5024 6150 | Tekli 150cm | 6 | 12,25 \$ |
| 5024 1230 | İkili 60cm | 6 | 10,50 \$ |
| 5024 1240 | İkili 120cm | 6 | 12,40 \$ |
| 5024 6140 | İkili 150cm | 6 | 14,25 \$ |

T8 Etanj Duyulu Sac Bant





IP 20 

53mm
97mm

| Kod No | Özellikler | Koli Adedi | Fiyat |
|-----------|--------------------------------|------------|----------|
| 5024 1212 | 1x18W T8 Etanj Duyulu Sac Bant | 6 | 25,30 \$ |
| 5024 1232 | 2x18W T8 Etanj Duyulu Sac Bant | 6 | 27,30 \$ |
| 5024 1222 | 1x36W T8 Etanj Duyulu Sac Bant | 6 | 26,30 \$ |
| 5024 1242 | 2x36W T8 Etanj Duyulu Sac Bant | 6 | 28,30 \$ |
| 5024 6152 | 1x58W T8 Etanj Duyulu Sac Bant | 6 | 27,30 \$ |
| 5024 6142 | 2x58W T8 Etanj Duyulu Sac Bant | 6 | 29,30 \$ |

Etanj Duyulu Polyester Bant LED Tüp





IP 65 

68mm
130mm

| Kod No | Özellikler | Koli Adedi | Fiyat |
|-----------|-------------|------------|----------|
| 5024 1020 | Tekli 120cm | 6 | 14,90 \$ |
| 5024 1030 | İkili 120cm | 6 | 16,90 \$ |
| 5024 6040 | Tekli 150cm | 6 | 16,25 \$ |
| 5024 6050 | İkili 150cm | 6 | 18,80 \$ |

T8 Etanj Duyulu Polyester Bant



IP 65 

68mm
130mm

| Kod No | Özellikler | Koli Adedi | Fiyat |
|-----------|-------------------------|------------|----------|
| 5024 1022 | 1x36W T8 Polyester Bant | 6 | 30,00 \$ |
| 5024 1032 | 2x36W T8 Polyester Bant | 6 | 32,00 \$ |
| 5024 6042 | 1x58W T8 Polyester Bant | 6 | 31,30 \$ |
| 5024 6052 | 2x58W T8 Polyester Bant | 6 | 33,30 \$ |

Yedek Parçalar

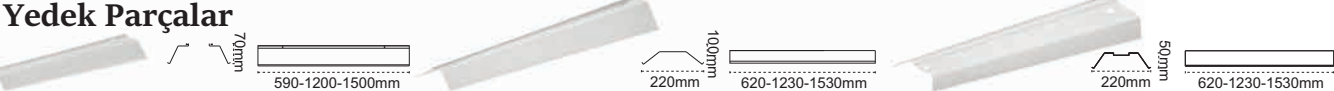

| Kod No | Özellikler | Koli Adedi | Fiyat |
|----------|-----------------------|------------|---------|
| 4201 815 | Standart TMS 18W Ref. | 10 | 4,50 \$ |
| 4201 816 | Standart TMS 36W Ref. | 10 | 5,20 \$ |
| 4201 817 | Standart TMS 58W Ref. | 10 | 6,80 \$ |

| Kod No | Özellikler | Koli Adedi | Fiyat |
|----------|-----------------------|------------|---------|
| 4201 806 | Geçmeli Bant 18W Ref. | 10 | 5,20 \$ |
| 4201 807 | Geçmeli Bant 36W Ref. | 10 | 7,10 \$ |
| 4201 808 | Geçmeli Bant 58W Ref. | 10 | 8,60 \$ |

| Kod No | Özellikler | Koli Adedi | Fiyat |
|----------|----------------------------------|------------|---------|
| 4201 810 | Etanj Duyulu Sac Bant 18W Ref. | 10 | 4,50 \$ |
| 4201 811 | Etanj Duyulu Sac Bant 36W Ref. | 10 | 5,80 \$ |
| 4201 812 | Etanj Duyulu Sac Bant 58W Ref. | 10 | 6,70 \$ |
| 4201 821 | Etanj Duyulu Poly. Bant 36W Ref. | 10 | 7,10 \$ |
| 4201 822 | Etanj Duyulu Poly. Bant 58W Ref. | 10 | 8,90 \$ |

Largo LED

2x36 W Elektronik Balastlı Etanj Muadili

Largo Lux Opsiyonlar

Elektronik balastlı armatürlere göre %55 enerji tasarrufu

- Dim (Dali 1-10V)
- Acil aydınlatma kiti
- Harici sensör
- Koridor fonsiyonu

- Floresana göre 2 kat daha uzun ömür
- Toz ve su almaz, IP65
- Kaliteli komponentler ile ömrü boyunca yüksek verimli ışık çıkışı 3000K / 4000K / 6500K

Largo LED



| Kod No | Özellikler | Koli Adedi | Fiyat |
|-----------|--|------------|----------|
| 5615 3511 | Largo LED 36W 120cm | 6 | 45,00 \$ |
| 5615 3561 | Largo LED 20W 60cm | 6 | 36,00 \$ |
| 5615 3521 | Largo LED 20W 120cm | 6 | 38,00 \$ |
| 5615 3514 | Largo LED 36W 120cm Acil Aydınlatma Kiti | 6 | 75,00 \$ |

Largo LED Lux



| Kod No | Özellikler | Koli Adedi | Fiyat |
|-----------|-------------------------|------------|----------|
| 5615 6361 | Largo LED Lux 21W 60cm | 6 | 49,00 \$ |
| 5615 6371 | Largo LED Lux 42W 120cm | 6 | 57,00 \$ |
| 5615 6387 | Largo LED Lux 63W 150cm | 6 | 95,00 \$ |

Largo LED Frozen



IP 65 ☺ • Soğuk hava depoları ve donuk ürün depoları kullanımı için uygundur.

| Kod No | Özellikler | Koli Adedi | Fiyat |
|-----------|-------------------------------------|------------|-----------|
| 5615 6364 | Largo LED Frozen 21W 60cm (-25° C) | 6 | 119,00 \$ |
| 5615 6374 | Largo LED Frozen 42W 120cm (-40° C) | 6 | 229,00 \$ |
| 5615 6389 | Largo LED Frozen 63W 150cm (-40° C) | 6 | 339,00 \$ |

Largo LED Radar Sensörlü ve Acil Aydınlatma Kitli



IP 65 ☺

| Kod No | Özellikler | Koli Adedi | Fiyat |
|-----------|---|------------|----------|
| 5615 3534 | Largo LED 36W 120cm Radar Sensörlü ve Kitli | 6 | 90,00 \$ |
| 5615 3531 | Largo LED 36W 120cm Radar Sensörlü | 6 | 57,50 \$ |

Largo LED Tüp Tekli Şeffaf Cam



IP 65 ☺ • Acil aydınlatma kiti uygulanabilir (9-18W)

| Kod No | Özellikler | Koli Adedi | Fiyat |
|-----------|------------------------------|------------|----------|
| 5021 8220 | Largo LED Tüp Tekli 60cm | 6 | 12,50 \$ |
| 5021 8260 | Largo LED Tüp Tekli 120cm | 6 | 16,60 \$ |
| 5021 8450 | Largo LED Tüp Tekli 150cm | 6 | 24,20 \$ |
| 5913 1460 | 9-18W LED Tüp Konvertör Kiti | 100 | 52,60 \$ |

Largo LED Tüp İkili Şeffaf Cam



IP 65 ☺ • Acil aydınlatma kiti uygulanabilir (9-18W)

| Kod No | Özellikler | Koli Adedi | Fiyat |
|-----------|------------------------------|------------|----------|
| 5021 8240 | Largo LED Tüp İkili 60cm | 6 | 13,60 \$ |
| 5021 8280 | Largo LED Tüp İkili 120cm | 6 | 18,70 \$ |
| 5021 8460 | Largo LED Tüp İkili 150cm | 6 | 28,80 \$ |
| 5913 1460 | 9-18W LED Tüp Konvertör Kiti | 100 | 52,60 \$ |

1,5 Yıl Geri Ödeme Süresi

- 100 lm/W'ı aşan verimlilik
- Avrupa LED çip
- Avrupa LED driver
- Alüminyum gövde
- Su ve toz almaz IP65
- Kamaşma kontrollü opal difüzör

Opsiyonlar

- Dali driver
- Acil aydınlatma kit
- Harici sensör uygulaması

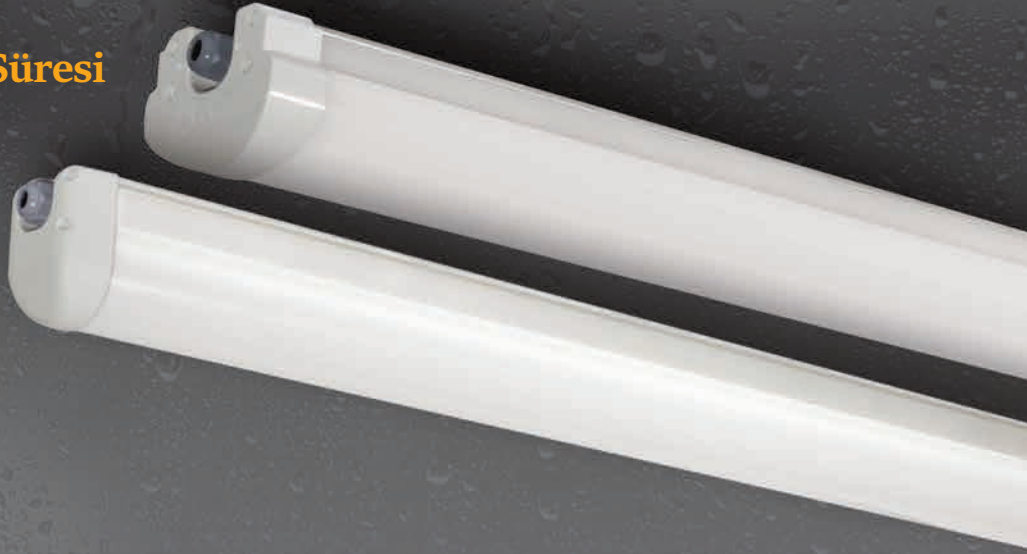

Solida

IP65 LED Etanj

- Alüminyum Gövde



85mm
73mm

IP 65

| Kod No | Özellikler | Koli Adedi | Fiyat |
|-----------|------------------|------------|-----------|
| 5614 2113 | Solida 23W 60cm | 6 | 66,00 \$ |
| 5614 2133 | Solida 35W 90cm | 6 | 85,00 \$ |
| 5614 2153 | Solida 45W 120cm | 6 | 113,00 \$ |
| 5614 2163 | Solida 65W 120cm | 6 | 150,00 \$ |

Prota

IP65 LED Etanj

- Alüminyum Gövde



87mm

IP 65

| Kod No | Özellikler | Koli Adedi | Fiyat |
|-----------|-----------------|------------|-----------|
| 5614 2213 | Prota 23W 60cm | 6 | 56,50 \$ |
| 5614 2233 | Prota 35W 90cm | 6 | 75,50 \$ |
| 5614 2253 | Prota 45W 120cm | 6 | 103,50 \$ |
| 5614 2263 | Prota 65W 120cm | 6 | 141,50 \$ |

Inoaled

IP66 LED Etanj

- Alüminyum Gövde



75mm
70mm

IP 66

| Kod No | Özellikler | Koli Adedi | Fiyat |
|-----------|--------------------|------------|-----------|
| 5614 1671 | Inoaled 21W 60 cm | 6 | 68,00 \$ |
| 5614 1531 | Inoaled 42W 120 cm | 6 | 102,00 \$ |
| 5614 1501 | Inoaled 63W 150 cm | 6 | 132,50 \$ |

Mar Etanj



180mm
96mm

IP 65

| Kod No | Özellikler | Koli Adedi | Fiyat |
|-----------|--------------------------|------------|----------|
| 5021 1530 | Mar LED Tüp Üçlü 60cm | 4 | 27,00 \$ |
| 5021 1540 | Mar LED Tüp Dörtlü 60cm | 4 | 28,00 \$ |
| 5021 1550 | Mar LED Tüp Üçlü 120cm | 4 | 37,00 \$ |
| 5021 1560 | Mar LED Tüp Dörtlü 120cm | 4 | 38,00 \$ |
| 5021 1570 | Mar LED Tüp Üçlü 150cm | 4 | 57,00 \$ |
| 5021 1580 | Mar LED Tüp Dörtlü 150cm | 4 | 58,00 \$ |

Largo T8

IP65 Etanj

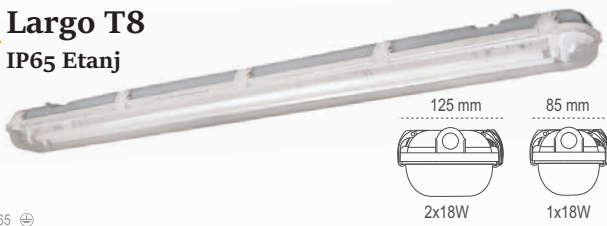

125 mm
85 mm
86mm

2x18W
1x18W

IP 65

| Kod No | Özellikler | Koli Adedi | Fiyat |
|-----------|----------------------------|------------|----------|
| 5021 8222 | Largo 1x18W Elek. Bal. TLD | 6 | 20,50 \$ |
| 5021 8242 | Largo 2x18W Elek. Bal. TLD | 6 | 21,50 \$ |
| 5021 8262 | Largo 1x36W Elek. Bal. TLD | 6 | 24,60 \$ |
| 5021 8282 | Largo 2x36W Elek. Bal. TLD | 6 | 27,20 \$ |
| 5021 8452 | Largo 1x58W Elek. Bal. TLD | 6 | 32,30 \$ |
| 5021 8462 | Largo 2x58W Elek. Bal. TLD | 6 | 37,30 \$ |

Solta T8

IP65 Etanj



124 mm
79 mm
98mm

2x18W
1x18W

IP 65

- PC Gövde / PC Cam

| Kod No | Özellikler | Koli Adedi | Fiyat |
|-----------|----------------------------|------------|----------|
| 5021 9562 | Solta 1X18W Elek. Bal. TLD | 6 | 26,30 \$ |
| 5021 9572 | Solta 2X18W Elek. Bal. TLD | 6 | 27,00 \$ |
| 5021 9582 | Solta 1X36W Elek. Bal. TLD | 6 | 31,70 \$ |
| 5021 9592 | Solta 2X36W Elek. Bal. TLD | 6 | 37,40 \$ |

2x10W Emergency Spot



Acil Durumlar
Pelsan Güvencesinde

2x10W LEDli 6 Saat

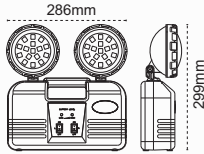

IP 40

| Kod No | Özellikler | Koli Adedi | Fiyat |
|-----------|--------------------|------------|-----------|
| 5514 1130 | 2x10W LEDli 6 Saat | 8 | 103,70 \$ |

2x5W LEDli 4 Saat

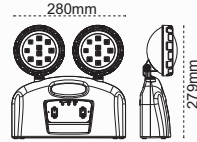

IP 40

| Kod No | Özellikler | Koli Adedi | Fiyat |
|-----------|-------------------|------------|----------|
| 5514 1120 | 2x5W LEDli 4 Saat | 8 | 56,70 \$ |

2x3W LEDli 5 Saat

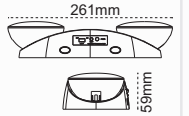

IP 40

| Kod No | Özellikler | Koli Adedi | Fiyat |
|-----------|-------------------|------------|----------|
| 5514 1110 | 2x3W LEDli 5 Saat | 10 | 29,00 \$ |

24 LEDli AC/DC Emergency

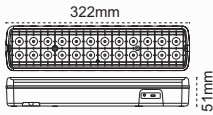

IP 20

| Kod No | Özellikler | Koli Adedi | Fiyat |
|-----------|----------------|------------|----------|
| 5514 1140 | 24 LEDli AC/DC | 20 | 15,50 \$ |

IP65 30 LEDli AC/DC Emergency

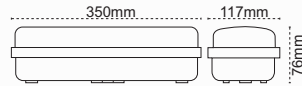

IP 65

| Kod No | Özellikler | Koli Adedi | Fiyat |
|-----------|-------------|------------|----------|
| 5514 1060 | 5W 30 LEDli | 12 | 38,80 \$ |

Ufo Acil Aydınlatma Spotu

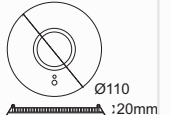

IP 40

| Kod No | Özellikler | Koli Adedi | Fiyat |
|-----------|------------|------------|----------|
| 5615 2031 | 3W 3000K | 20 | 56,60 \$ |

LEDli Işıldak



- 2 kademeli çalışma
- 8 saati aşan çalışma süresi
- Uzun ömürlü Ni-Cd batarya

90 LEDli Işıldak

Yeni Ürün

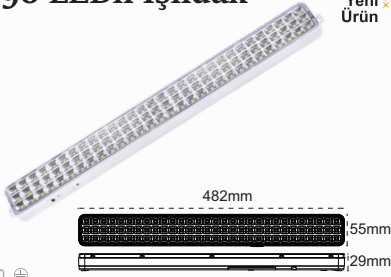

IP 40

| Kod No | Özellikler | Koli Adedi | Fiyat |
|-----------|------------------|------------|----------|
| 5061 1290 | 90 LEDli Işıldak | 20 | 21,25 \$ |

60 LEDli Işıldak

Yeni Ürün

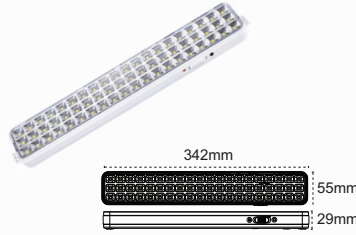

IP 40

| Kod No | Özellikler | Koli Adedi | Fiyat |
|-----------|---------------------|------------|----------|
| 5061 1260 | 40-60 LEDli Işıldak | 24 | 13,20 \$ |

30 LEDli Işıldak

Yeni Ürün

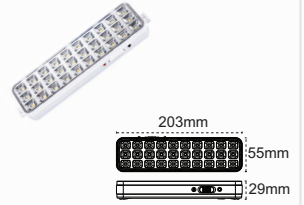

IP 40

| Kod No | Özellikler | Koli Adedi | Fiyat |
|-----------|------------------|------------|---------|
| 5061 1270 | 30 LEDli Işıldak | 40 | 7,55 \$ |

24+6 LEDli Işıldak



IP 20

| Kod No | Özellikler | Koli Adedi | Fiyat |
|-----------|--------------------|------------|---------|
| 5061 1170 | 24+6 LEDli Işıldak | 60 | 7,60 \$ |

24 LEDli Kamp Feneri Kırmızı

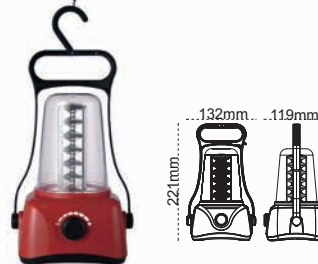

IP 20

| Kod No | Özellikler | Koli Adedi | Fiyat |
|-----------|------------------------------|------------|----------|
| 5061 1380 | 24 LEDli Kamp Feneri Kırmızı | 10 | 12,70 \$ |

24 LEDli Kamp Feneri Beyaz



IP 20

| Kod No | Özellikler | Koli Adedi | Fiyat |
|-----------|----------------------------|------------|----------|
| 5061 1390 | 24 LEDli Kamp Feneri Beyaz | 10 | 12,70 \$ |

16 LEDli El Feneri



IP 20

| Kod No | Özellikler | Koli Adedi | Fiyat |
|-----------|--------------------|------------|----------|
| 5061 1110 | 16 LEDli El Feneri | 30 | 11,80 \$ |

9 LEDli El Feneri



IP 20

| Kod No | Özellikler | Koli Adedi | Fiyat |
|-----------|-------------------------|------------|---------|
| 5061 1200 | 9 LEDli El Feneri Gümüş | 128 | 2,55 \$ |
| 5601 1210 | 9 LEDli El Feneri Bordo | 128 | 2,55 \$ |
| 5061 1220 | 9 LEDli El Feneri Krom | 128 | 2,55 \$ |
| 5601 1230 | 9 LEDli El Feneri Siyah | 128 | 2,55 \$ |

4+1 LEDli Çakılı El Feneri



IP 40

| Kod No | Özellikler | Koli Adedi | Fiyat |
|-----------|----------------------------|------------|---------|
| 5061 1310 | 4+1 LEDli Çakılı El Feneri | 50 | 4,50 \$ |

200 Çeşit Etiket Opsiyonu!



- 200 çeşit etiket opsiyonu 5513 1741, 5513 1751, 5513 1522, 5513 1512 kodları için geçerlidir.
- Ürün Kodu ile birlikte etiket seçiminizi bildiriniz.



S.A Exiled Exit Etiket Opsiyonu

opsiyonlu etiket

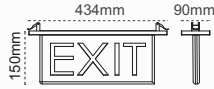

| Kod No | Özellikler | Koli Adedi | Fiyat |
|-----------|-------------------------------|------------|----------|
| 5513 1741 | S.A Tek Yön Opsiyonlu Exiled | 10 | 19,30 \$ |
| 5513 1751 | S.A Çift Yön Opsiyonlu Exiled | 10 | 24,00 \$ |

Exiled Exit Etiket Opsiyonu

opsiyonlu etiket

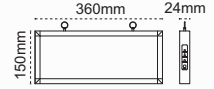

| Kod No | Özellikler | Koli Adedi | Fiyat |
|-----------|---------------------------|------------|----------|
| 5513 1522 | Tek Yön Opsiyonu Exiled | 10 | 14,60 \$ |
| 5513 1512 | Çift Yön Opsiyonlu Exiled | 10 | 19,30 \$ |

Exiled Exit Tek Yön

sabit etiketli

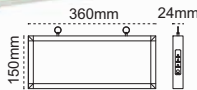

| Kod No | Özellikler | Koli Adedi | Fiyat |
|-----------|-------------------|------------|---------|
| 5513 1521 | Tek Yön 3W 3 Saat | 10 | 9,90 \$ |

Exiled Exit Çift Yön

sabit etiketli

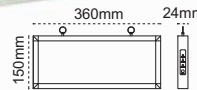

| Kod No | Özellikler | Koli Adedi | Fiyat |
|-----------|--------------------|------------|---------|
| 5513 1511 | Çift Yön 3W 3 Saat | 10 | 9,90 \$ |

Exiled Exit Çift Yön

sabit etiketli

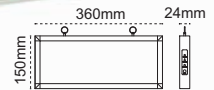

| Kod No | Özellikler | Koli Adedi | Fiyat |
|-----------|--------------------|------------|---------|
| 5513 1410 | Çift Yön 3W 3 Saat | 10 | 9,90 \$ |

Exiled Exit Çift Yön

sabit etiketli

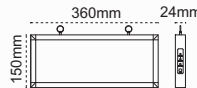

| Kod No | Özellikler | Koli Adedi | Fiyat |
|-----------|--------------------|------------|---------|
| 5513 1430 | Çift Yön 3W 3 Saat | 10 | 9,90 \$ |

Exiled Exit Çift Yön

sabit etiketli

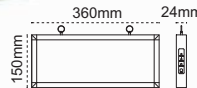

| Kod No | Özellikler | Koli Adedi | Fiyat |
|-----------|--------------------|------------|---------|
| 5513 1440 | Çift Yön 3W 3 Saat | 10 | 9,90 \$ |

Exiled Exit Çift Yön

sabit etiketli

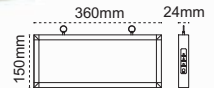

| Kod No | Özellikler | Koli Adedi | Fiyat |
|-----------|--------------------|------------|---------|
| 5513 1420 | Çift Yön 3W 3 Saat | 10 | 9,90 \$ |

Vialed Sarkıt

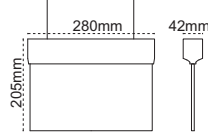

IP 20

| Kod No | Özellikler | Koli Adedi | Fiyat |
|-----------|--------------------|------------|----------|
| 5513 4210 | Tek Yön Sarkıt 3W | 1 | 30,10 \$ |
| 5513 4220 | Çift Yön Sarkıt 3W | 1 | 33,30 \$ |

S.Ü.Vialed

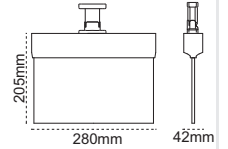

IP 20

| Kod No | Özellikler | Koli Adedi | Fiyat |
|-----------|---------------------------|------------|----------|
| 5513 4010 | Mafsallı Tek Yön Exit 3W | 1 | 30,10 \$ |
| 5513 4020 | Mafsallı Çift Yön Exit 3W | 1 | 33,30 \$ |

S.A Vialed

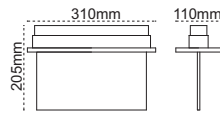

IP 20

| Kod No | Özellikler | Koli Adedi | Fiyat |
|-----------|-----------------|------------|----------|
| 5513 4110 | S.A Tek Yön 3W | 1 | 37,70 \$ |
| 5513 4120 | S.A Çift Yön 3W | 1 | 41,00 \$ |

S.Ü.Vialed 55 cm

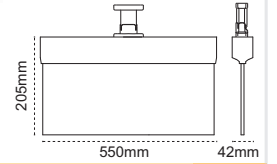

IP 20

| Kod No | Özellikler | Koli Adedi | Fiyat |
|-----------|------------------------|------------|----------|
| 5513 4030 | Mafsallı Tek Yön Exit | 1 | 62,10 \$ |
| 5513 4040 | Mafsallı Çift Yön Exit | 1 | 65,90 \$ |
| 5513 4230 | Sarkıt Tek Yön Exit | 1 | 62,10 \$ |
| 5513 4240 | Sarkıt Çift Yön Exit | 1 | 65,90 \$ |

24 LEDli AC/DC Emergency

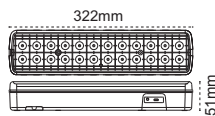

● Exit / Çıkış etiketi hediye

IP 20

| Kod No | Özellikler | Koli Adedi | Fiyat |
|-----------|----------------|------------|----------|
| 5514 1140 | 24 LEDli AC/DC | 20 | 15,50 \$ |

IP65 30 LEDli AC/DC Emergency

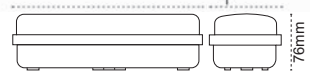

● Dört farklı yönlendirme etiketi hediye

IP 65

| Kod No | Özellikler | Koli Adedi | Fiyat |
|-----------|-------------|------------|----------|
| 5514 1060 | 5W 30 LEDli | 12 | 38,80 \$ |



Pelsan Okul Armatürleri

Clear



IP 40

| Kod No | Özellikler | Koli Adedi | Fiyat |
|-----------|-----------------------------------|------------|----------|
| 5615 3211 | Clear LED 36W 120 CM | 1 | 45,00 \$ |
| 5017 9002 | T1 Clear 1X18W T8 Arm. Elek. Bal. | 1 | 21,50 \$ |
| 5017 9012 | T1 Clear 2X18W T8 Arm. Elek. Bal. | 1 | 26,00 \$ |
| 5017 9022 | T1 Clear 1X36W T8 Arm. Elek. Bal. | 1 | 26,80 \$ |
| 5017 9032 | T1 Clear 2X36W T8 Arm. Elek. Bal. | 1 | 32,30 \$ |

Plex



IP 40

| Kod No | Özellikler | Koli Adedi | Fiyat |
|-----------|---------------------------|------------|----------|
| 5019 5212 | Opal 2x18W Elek. Bal. TLD | 1 | 26,80 \$ |
| 5019 5222 | Opal 2x36W Elek. Bal. TLD | 1 | 33,20 \$ |

Linea Large LED



IP 40

- Homojen ışık
- İç mekan ve endüstriyel alanlarda kullanıma uygun

| Kod No | Özellikler | Koli Adedi | Fiyat |
|-----------|---------------------------------|------------|----------|
| 5610 2110 | Linea Large LED 18W 6500K 60cm | 20 | 15,60 \$ |
| 5610 2120 | Linea Large LED 36W 6500K 120cm | 20 | 23,40 \$ |
| 5610 2130 | Linea Large LED 18W 4000K 60cm | 20 | 15,60 \$ |
| 5610 2140 | Linea Large LED 36W 4000K 120cm | 20 | 23,40 \$ |

Linea IP65 LED



Yeni Ürün



IP 65

- Homojen ışık
- Endüstriyel alanlarda kullanıma uygun

| Kod No | Özellikler | Koli Adedi | Fiyat |
|-----------|--------------------------------|------------|----------|
| 5610 2190 | Linea LED IP65 36W 4000K 120cm | 10 | 24,90 \$ |
| 5610 2170 | Linea LED IP65 36W 6500K 120cm | 10 | 24,90 \$ |

Linea LED



- Anahtarlı ve eklenebilir form
- Sürekli ve homojen ışık
- Bitiş kapağı sayesinde güvenli kurulum
- İç mekan ve endüstriyel alanlarda kullanıma uygun



IP 40



Aparatlar fiyata dahildir.
(Enerji kablosu, 15 cm esnek bağlantı aparatı, mini bağlantı aparatı, zemin montajı için gerekli klipsler, bitiş kapağı)

| Kod No | Özellikler | Koli Adedi | Fiyat |
|-----------|-----------------------------|------------|----------|
| 5951 6260 | Linea LED 4W 6500K 30cm | 30 | 7,60 \$ |
| 5951 6270 | Linea LED 8W 6500K 60cm | 30 | 9,20 \$ |
| 5951 6280 | Linea LED 16W 6500K 117,3cm | 30 | 19,50 \$ |
| 3515 301 | Linea LED Fiş Kablo | 150 | 1,90 \$ |

Modern yapısı ile atölye gibi endüstriyel ortamlarda, ofis - mağaza - marketler gibi tasarımın önemli olduğu mekanlarda kullanıma uygundur.



Volga LED

- 50W
- 50.000 saat uzun ömür
- Renksel geriverim >80



Volga

- E27 Duylu
- 30W ve 40W Pelsan LED lambalar ile kullanıma uygun

Volga LED



IP20

| Kod No | Özellikler | Koli Adedi | Fiyat |
|-----------|---------------------------------|------------|----------|
| 5616 4741 | Volga 50W LED Gümüş Atölye Arm. | 6 | 75,40 \$ |
| 5616 4751 | Volga 50W LED Beyaz Atölye Arm. | 6 | 75,40 \$ |

Volga



IP20

| Kod No | Özellikler | Koli Adedi | Fiyat |
|-----------|-----------------------------|------------|----------|
| 5212 4011 | Volga E27 Gümüş Atölye Arm. | 6 | 37,80 \$ |
| 5212 4021 | Volga E27 Beyaz Atölye Arm. | 6 | 37,80 \$ |

Gediz



Øxaxbmm
160W/420x260x175
250W/420x310x175
500W/500x322x143

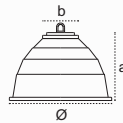

IP 65/20

| Kod No | Özellikler | Koli Adedi | Fiyat |
|-----------|-------------------------------------|------------|----------|
| 5212 1010 | Gediz 160W E27 Alm. Atölye Arm Boş. | 10 | 18,90 \$ |
| 4080 701 | Q402mm Cam+Conta+Klips | 10 | 10,25 \$ |
| 4101 521 | Q420mm Tel Kafes | 1 | 7,50 \$ |

Fırat

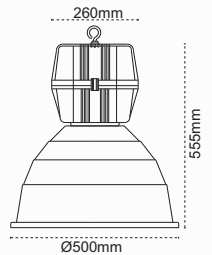

IP 65/20

| Kod No | Özellikler | Koli Adedi | Fiyat |
|-----------|---|------------|----------|
| 5212 1121 | Fırat 250W E40 MH/SB Poly. Atölye Arm. | 4 | 63,90 \$ |
| 5212 1191 | Fırat 400W E40 MH Poly. Atölye Arm. | 4 | 70,60 \$ |
| 5212 1201 | Fırat 400W E40 SB Poly. Atölye Arm. | 4 | 77,60 \$ |
| 4080 702 | Atölye Camı (482X4mm) + Conta ve Mandal | 1 | 12,40 \$ |
| 4101 522 | 400W Atölye Tel Kafes | 1 | 9,90 \$ |

Karpat LED

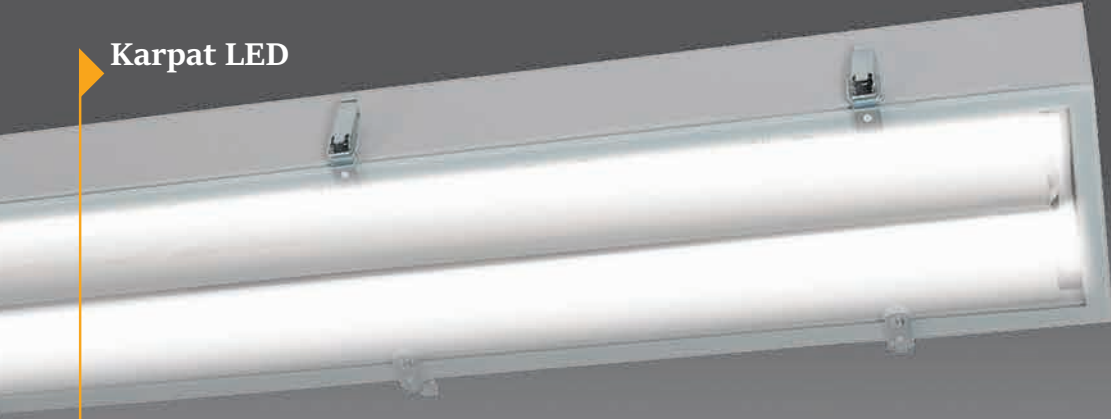

- Temperli ve filmli cam
- Yüksek ve alçak tavan uygulamaları için uyumlu
- Avrupa LED çip ve sürücü

Opsiyonlar

- Acil aydınlatma kiti
- Harici sensör uygulaması
- DALI, 1-10V Dim
- Busbar askı takımı
- Koridor fonksiyonu

Her Sektöre Uygun Yüksek Tavan Çözümünüz

Karpat LED Performans

130 lm/W verimlilik

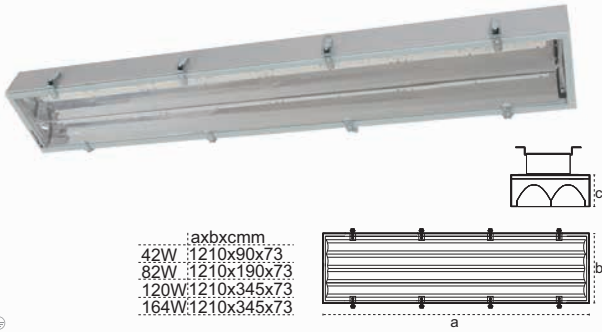

:axbxcmm
 42W :1210x90x73
 82W :1210x190x73
 120W:1210x345x73
 164W:1210x345x73

IP 65

| Kod No | Özellikler | Koli Adedi | Fiyat |
|-----------|---------------------------------------|------------|-----------|
| 5615 6461 | Karpat LED Performans 40W 4000/6500K | 1 | 122,50 \$ |
| 5615 6471 | Karpat LED Performans 75W 4000/6500K | 1 | 160,50 \$ |
| 5615 6481 | Karpat LED Performans 110W 4000/6500K | 1 | 245,50 \$ |
| 5615 6491 | Karpat LED Performans 150W 4000/6500K | 1 | 282,50 \$ |

Karpat LED Standart

110 lm/W verimlilik

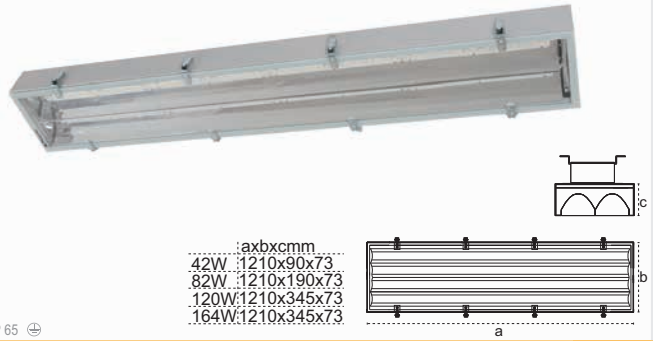

:axbxcmm
 42W :1210x90x73
 82W :1210x190x73
 120W:1210x345x73
 164W:1210x345x73

IP 65

| Kod No | Özellikler | Koli Adedi | Fiyat |
|-----------|-------------------------------------|------------|-----------|
| 5615 6261 | Karpat LED Standart 42W 4000/6500K | 1 | 103,00 \$ |
| 5615 6241 | Karpat LED Standart 82W 4000/6500K | 1 | 141,00 \$ |
| 5615 6281 | Karpat LED Standart 120W 4000/6500K | 1 | 192,00 \$ |
| 5615 6251 | Karpat LED Standart 164W 4000/6500K | 1 | 259,60 \$ |

Karpat LED Frozen

-40°C dereceye kadar düşük sıcaklıkta yüksek verimle çalışma

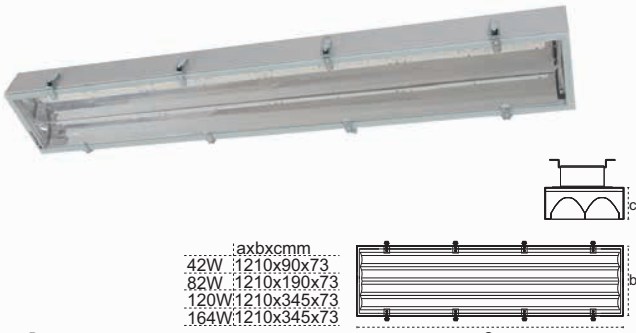

:axbxcmm
 42W :1210x90x73
 82W :1210x190x73
 120W:1210x345x73
 164W:1210x345x73

IP 65

| Kod No | Özellikler | Koli Adedi | Fiyat |
|-----------|-----------------------------------|------------|-----------|
| 5615 6262 | Karpat LED Frozen 42W 4000/6500K | 1 | 240,00 \$ |
| 5615 6242 | Karpat LED Frozen 82W 4000/6500K | 1 | 465,00 \$ |
| 5615 6252 | Karpat LED Frozen 164W 4000/6500K | 1 | 620,00 \$ |

Karpat T5

HID lambalara göre daha yüksek enerji tasarrufu



:axbxcmm
 2x54W:1210x190x82
 4x54W:1210x345x82
 2x80W:1510x190x82
 4x80W:1510x345x82

IP 65

| Kod No | Özellikler | Koli Adedi | Fiyat |
|-----------|-----------------|------------|-----------|
| 5014 2972 | Karpat 2X54W T5 | 1 | 88,00 \$ |
| 5014 2992 | Karpat 4X54W T5 | 1 | 145,00 \$ |
| 5014 4882 | Karpat 2X80W T5 | 1 | 105,00 \$ |
| 5014 4962 | Karpat 4X80W T5 | 1 | 184,00 \$ |

Sia

IP65 LED Yüksek Tavan Armatürü

Opsiyonlar

- Dar, geniş, asimetrik lens seçenekleri
- DALI dim
- Siyah, beyaz, gri renk opsiyonu



- Power LED 100.000 saati aşan ömür
- Alüminyum enjeksiyon gövde
- 120 lümen /W' a varan verimlilik
- 1-10V dim standart 2-Step dim standart
- 15-25 metre yüksek tavan uygulaması
- Temperli cam ile güvenli

| | .axbxcmm |
|------|-------------|
| 75W | 342x342x123 |
| 100W | 342x342x123 |
| 125W | 342x342x123 |

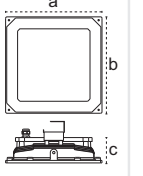

IP 65

| Kod No | Özellikler | Koli Adedi | Fiyat |
|-----------|---------------------|------------|-----------|
| 5616 4421 | Sia 75W 4000/6500K | 1 | 255,00 \$ |
| 5616 4431 | Sia 100W 4000/6500K | 1 | 295,00 \$ |
| 5616 4441 | Sia 125W 4000/6500K | 1 | 340,00 \$ |

Castor

IP65 LED Yüksek Tavan Armatürü



- Alüminyum enjeksiyon gövde
- Hafif gövdesi ile kolay montaj ve kurulum
- >90 lm/W
- 3 farklı boy seçeneği
- PC hammaddeli, kamaşma yapmayan optik difüzör
- 30cm zincir aparatı ile sarkıtılabilir

| | .axbxcmm |
|------|-------------|
| 100W | 295x295x90 |
| 150W | 345x345x95 |
| 200W | 395x395x105 |

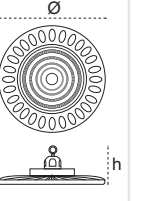

IP 65

| Kod No | Özellikler | Koli Adedi | Fiyat |
|-----------|-------------------|------------|-----------|
| 5616 2810 | Castor 100W 5000K | 6 | 95,00 \$ |
| 5616 2820 | Castor 150W 5000K | 4 | 150,00 \$ |
| 5616 2830 | Castor 200W 5000K | 3 | 199,00 \$ |

Yeni
Ürün

Oriza

IP65 Yüksek Tavan Armatürü

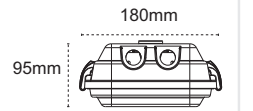

IP 65

| Kod No | Özellikler | Koli Adedi | Fiyat |
|-----------|----------------------------------|------------|-----------|
| 5055 7352 | Oriza 2X54W T5 Elek. Bal. 1285mm | 1 | 73,00 \$ |
| 5055 7362 | Oriza 2X80W T5 Elek. Bal. 1595mm | 1 | 89,00 \$ |
| 5615 3311 | Oriza LED 82W 4000/6500K 1285mm | 1 | 103,00 \$ |

IP 65 ● Basbar askı takımı opsiyonu

Busbar Askı Takımı

Karpat ve Oriza yüksek tavan armatürlerinin her varyasyonu için uygundur.

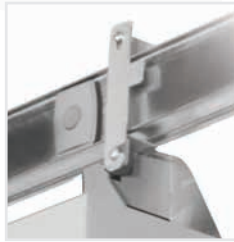

| | .axbmm |
|--------|--------|
| Busbar | 35x55 |
| Busbar | 23x45 |
| Busbar | 28x62 |

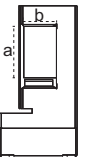

- Basbar askı takımı opsiyonu

| Kod No | Özellikler | Koli Adedi | Fiyat |
|----------|--------------------|------------|---------|
| 4001 449 | Busbar Askı Takımı | 1 | 8,50 \$ |
| 4001 468 | Busbar Askı Takımı | 1 | 8,50 \$ |
| 4001 469 | Busbar Askı Takımı | 1 | 8,50 \$ |



Yüksek Performanslı Pelsan Benzinlik Armatürleri

- Haff gövdesi ile kolay montaj ve kurulum
- İnce alüminyum yapısı ile dayanıklı ve modern görünüm
- Yüksek verimli komponentleri ile ömrü boyunca yüksek ışık çıkışı
- Enerji tasarrufu ve bakım gerektirmeyen yapısı ile ekonomik çözüm
- Temperli cam ile güvenlik sağlar

Piroliz

IP65 LED Kanopi Armatür



- 125 lümen /W 'a varan verimlilik
- Alüminyum gövde
- Temperli cam

Opsiyonlar

- 1-10V dim
- 2-Step dim
- Farklı açılarda lens uygulama

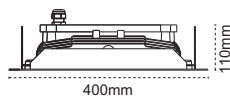

Okta

IP65 LED Kanopi Armatür



- 100 lümen /W 'a varan verimlilik
- Alüminyum gövde
- Temperli cam

Opsiyonlar

- DALI, 1-10V dim opsiyonu
- Siyah, beyaz ve gri renk opsiyonu

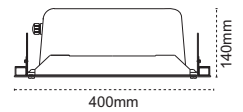

IP 65

| Kod No | Özellikler | Koli Adedi | Fiyat |
|-----------|---------------------------|------------|-----------|
| 5616 4071 | Piroliz 75W 4000 / 6500K | 1 | 255,00 \$ |
| 5616 4081 | Piroliz 100W 4000 / 6500K | 1 | 295,00 \$ |
| 5616 4091 | Piroliz 125W 4000 / 6500K | 1 | 340,00 \$ |

IP 65

| Kod No | Özellikler | Koli Adedi | Fiyat |
|-----------|---------------------------|------------|-----------|
| 5616 4341 | Okta LED 80W 4000 / 6500K | 1 | 199,00 \$ |

ATEX Belgeli

- **Gaz Patlama Koruması: Zone 2**
● II 3G Ex nR IIC T5 Gc
- **Toz Patlama Koruması: Zone 22**
● II 3D Ex tc IIIC (T95 C) Dc
- **Standartlar**
EN 60079-0: 2012, EN 60079-15: 2010,
EN 60079-31:2009
- **Sertifika Numarası**
IEP 16 ATEX 0468
- **Zone Sınıfı**
Zone 2
Zone 22

Ex-Proof armatürler, tehlikeli gaz ve toz maddelerinin bulunduğu, patlama riski olan ortamlarda kullanılan armatürlerdir.



Kimya ve Boya Tesisleri, Petrol Depolama Tesisleri, Petrol Dolum Boşaltım Tesisleri, Liman & Tersaneler, Enerji Santralleri, Endüstriyel Tesisler ve Akaryakıt İstasyonlarında Güvenle Kullanabilirsiniz!

Piroliz – Ex-Proof

IP66 LED Kanopi Armatür

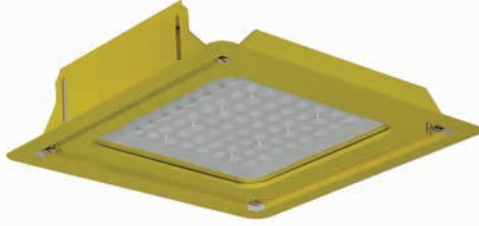

- **Gaz Patlama Koruması:**  II 3G Ex nR IIC T5 Gc
- **Toz Patlama Koruması:**  II 3D Ex tc IIIC (T95 C) Dc

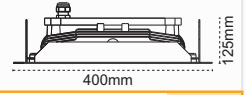

| Kod No | Özellikler | Koli Adedi | Fiyat |
|-----------|-------------------------------------|------------|-----------|
| 5616 4011 | Piroliz Ex 50W 3000 / 4000 / 6500K | 1 | 575,00 \$ |
| 5616 4021 | Piroliz Ex 75W 3000 / 4000 / 6500K | 1 | 650,00 \$ |
| 5616 4031 | Piroliz Ex 100W 3000 / 4000 / 6500K | 1 | 725,00 \$ |
| 5616 4041 | Piroliz Ex 125W 3000 / 4000 / 6500K | 1 | 800,00 \$ |
| 5616 4051 | Piroliz Ex 150W 3000 / 4000 / 6500K | 1 | 875,00 \$ |

Sia – Ex-Proof

IP66 LED Yüksek Tavan Armatürü

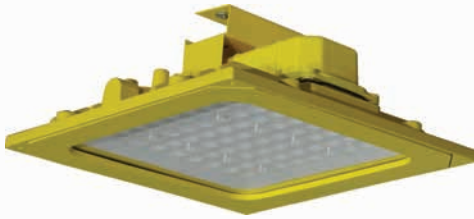

- **Gaz Patlama Koruması:**  II 3G Ex nR IIC T5 Gc
- **Toz Patlama Koruması:**  II 3D Ex tc IIIC (T95 C) Dc

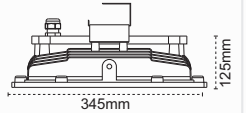

| Kod No | Özellikler | Koli Adedi | Fiyat |
|-----------|---------------------------------|------------|-----------|
| 5616 4251 | Sia Ex 50W 3000 / 4000 / 6500K | 1 | 575,00 \$ |
| 5616 4261 | Sia Ex 75W 3000 / 4000 / 6500K | 1 | 650,00 \$ |
| 5616 4271 | Sia Ex 100W 3000 / 4000 / 6500K | 1 | 725,00 \$ |
| 5616 4281 | Sia Ex 125W 3000 / 4000 / 6500K | 1 | 800,00 \$ |
| 5616 4291 | Sia Ex 150W 3000 / 4000 / 6500K | 1 | 875,00 \$ |

Nairo – Ex-Proof

IP66 LED Projektör



- **Gaz Patlama Koruması:**  II 3G Ex nR IIC T5 Gc
- **Toz Patlama Koruması:**  II 3D Ex tc IIIC (T95 C) Dc

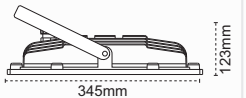

| Kod No | Özellikler | Koli Adedi | Fiyat |
|-----------|-----------------------------------|------------|-----------|
| 5616 3611 | Nairo Ex 50W 3000 / 4000 / 6500K | 1 | 575,00 \$ |
| 5616 3621 | Nairo Ex 75W 3000 / 4000 / 6500K | 1 | 650,00 \$ |
| 5616 3631 | Nairo Ex 100W 3000 / 4000 / 6500K | 1 | 725,00 \$ |
| 5616 3641 | Nairo Ex 125W 3000 / 4000 / 6500K | 1 | 800,00 \$ |
| 5616 3651 | Nairo Ex 150W 3000 / 4000 / 6500K | 1 | 875,00 \$ |



Pelsan LED Projektörler

Ria LED



Otomatik Gece Modu ile Daha Fazla Tasarruf!

- 100lm/W'ın üzerinde verimlilik
- Avrupa LED Çip
- Simetrik ve asimetric ışık dağılımı
- 50.000 saat ömür
- Açı ayarlanabilir konsol

★ Gece Modu
★ Opsiyonlu



Ria IP66 LED Projektör, müşterilerimizin isteğine göre kendini gecenin belirli bir saatinden sonra dimleyebilir. Bu özelliği ile LED'in sağladığı tasarrufa ekstra bir tasarruf sağlayarak enerji sarfiyatını minimuma düşürür.

Ria IP66 Power

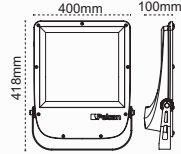

IP 66 ☺

| Kod No | Özellikler | Koli Adedi | Fiyat |
|-----------|---------------------------|------------|-----------|
| 5617 1701 | 100W Simetrik 4000K/6500K | 1 | 179,00 \$ |
| 5617 1711 | 150W Simetrik 4000K/6500K | 1 | 207,00 \$ |

Ria IP66 Power

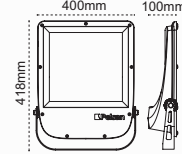

IP 66 ☺

| Kod No | Özellikler | Koli Adedi | Fiyat |
|-----------|---------------------------|------------|-----------|
| 5617 1752 | 100W Simetrik 4000K/6500K | 1 | 215,00 \$ |
| 5617 1762 | 125W Simetrik 4000K/6500K | 1 | 233,00 \$ |
| 5617 1772 | 150W Simetrik 4000K/6500K | 1 | 252,00 \$ |

Ria IP66 Simetrik

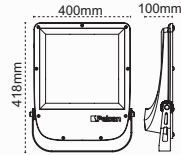

IP 66 ☺

| Kod No | Özellikler | Koli Adedi | Fiyat |
|-----------|---------------------------|------------|-----------|
| 5617 1881 | 180W Simetrik 4000K/6500K | 1 | 292,00 \$ |
| 5617 1891 | 200W Simetrik 4000K/6500K | 1 | 330,00 \$ |
| 5617 1731 | 240W Simetrik 4000K/6500K | 1 | 405,00 \$ |

Ria IP66 Asimetric

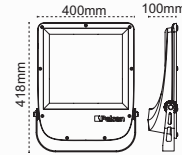

IP 66 ☺

| Kod No | Özellikler | Koli Adedi | Fiyat |
|-----------|----------------------------|------------|-----------|
| 5617 1831 | 180W Asimetric 4000K/6500K | 1 | 292,00 \$ |
| 5617 1841 | 200W Asimetric 4000K/6500K | 1 | 330,00 \$ |
| 5617 1721 | 240W Asimetric 4000K/6500K | 1 | 405,00 \$ |

Ria IP66 Power Lux

- Avrupa Driver

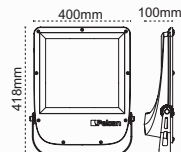

IP 66 ☺

| Kod No | Özellikler | Koli Adedi | Fiyat |
|-----------|---------------------------|------------|-----------|
| 5616 3571 | 140W Simetrik 4000K/6500K | 1 | 420,00 \$ |

Ria IP66 Power Lux

- Avrupa Driver

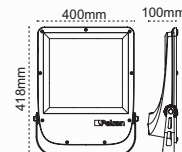

IP 66 ☺

| Kod No | Özellikler | Koli Adedi | Fiyat |
|-----------|---------------------------|------------|-----------|
| 5616 3581 | 215W Simetrik 4000K/6500K | 1 | 475,00 \$ |

Maxled

- 110 lm/W üzerinde etkinlik faktörü
- Avrupa LED çip & LED sürücü
- 15° / 30° / 45+20° lens açısı opsiyonu
- 1-10V Dim
- Sıva üstü açılı montaj, ikili montaj, direk montajına uygun

Opsiyonlar

- DALI Dim
- DMX kontrol



Maxled



axbxcmm
300W630x345x339
500W630x515x339

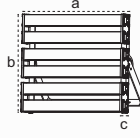

IP 66

| Kod No | Özellikler | Koli Adedi | Fiyat |
|-----------|-----------------|------------|-----------|
| 5617 2131 | 300W 4000/6500K | 1 | 564,00 \$ |
| 5617 2151 | 500W 4000/6500K | 1 | 940,00 \$ |

Inovaled Projektör

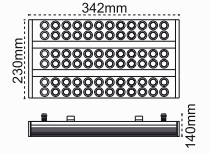

IP 65

| Kod No | Özellikler | Koli Adedi | Fiyat |
|-----------|-----------------|------------|-----------|
| 5614 1211 | 60W 4000K/6500K | 1 | 126,00 \$ |
| 5614 1231 | 90W 4000K/6500K | 1 | 195,00 \$ |

Liya

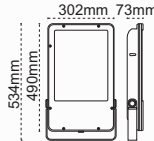

IP 65

| Kod No | Özellikler | Koli Adedi | Fiyat |
|-----------|---------------------------|------------|-----------|
| 5615 6731 | 103W Simetrik 4000K/6500K | 1 | 357,00 \$ |
| 5615 6732 | 154W Simetrik 4000K/6500K | 1 | 394,00 \$ |
| 5615 6733 | 180W Simetrik 4000K/6500K | 1 | 451,00 \$ |

Nairo

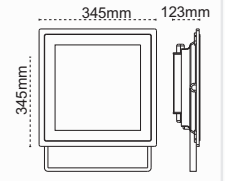

IP 65

| Kod No | Özellikler | Koli Adedi | Fiyat |
|-----------|------------------|------------|-----------|
| 5616 3671 | 75W 4000K/6500K | 1 | 255,00 \$ |
| 5616 3681 | 100W 4000K/6500K | 1 | 295,00 \$ |
| 5616 3791 | 125W 4000K/6500K | 1 | 340,00 \$ |

Forino

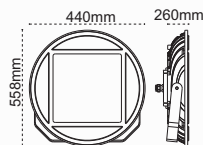

IP 65

| Kod No | Özellikler | Koli Adedi | Fiyat |
|-----------|---------------------------|------------|-----------|
| 5616 3961 | 103W 64 LEDli 4000K/6500K | 1 | 330,00 \$ |

Forino Med

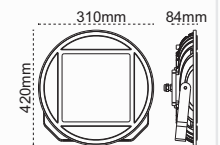

IP 65

| Kod No | Özellikler | Koli Adedi | Fiyat |
|-----------|-----------------------------------|------------|-----------|
| 5616 3972 | 59W 4000K/6500K | 1 | 196,00 \$ |
| 5616 3981 | 65W 4000K/6500K (Prizmatik Camlı) | 1 | 170,00 \$ |

Franko 100W

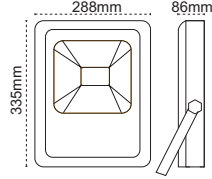

IP 65

| Kod No | Özellikler | Koli Adedi | Fiyat |
|-----------|------------------|------------|----------|
| 5617 1091 | 100W 4000K/6500K | 4 | 75,40 \$ |

Franko 70W

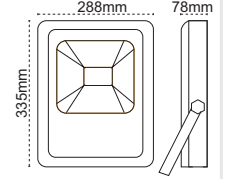

IP 65

| Kod No | Özellikler | Koli Adedi | Fiyat |
|-----------|-----------------|------------|----------|
| 5617 1081 | 70W 4000K/6500K | 4 | 54,60 \$ |

Franko 50W

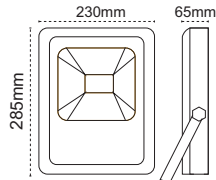

IP 65

| Kod No | Özellikler | Koli Adedi | Fiyat |
|-----------|-----------------|------------|----------|
| 5617 1071 | 50W 4000K/6500K | 6 | 35,80 \$ |

Franko 30W

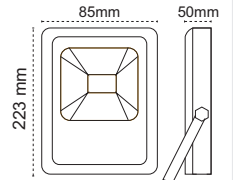

IP 65

| Kod No | Özellikler | Koli Adedi | Fiyat |
|-----------|------------|------------|----------|
| 5617 1051 | 30W 6500K | 10 | 24,50 \$ |

Franko 30-20W Sensörlü

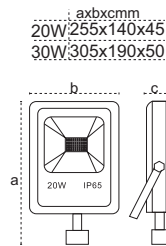

IP 65

| Kod No | Özellikler | Koli Adedi | Fiyat |
|-----------|--------------------|------------|----------|
| 5617 1621 | 20W Sensörlü 6500K | 20 | 28,30 \$ |
| 5617 1631 | 30W Sensörlü 6500K | 10 | 35,90 \$ |

Franko Projektör Ayağı



IP 65

| Kod No | Özellikler | Koli Adedi | Fiyat |
|-----------|------------------|------------|----------|
| 5617 1110 | Projektör Tripot | 4 | 35,00 \$ |

Franko

Beyan Ettiği Güç ve Lümeni Verir!

- Ömrü boyunca aynı lümen çıktısı
- 88 lm/W'ın üzerinde etkinlik faktörü
- 30.000 saat ömür
- Alüminyum gövde
- Ayarlanabilir konsol
- Toz ve su almaz, IP65



Franko 400W

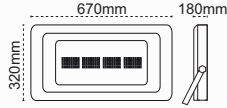

IP 65

| Kod No | Özellikler | Koli Adedi | Fiyat |
|-----------|----------------|------------|-----------|
| 5617 1411 | 400W 5000K | 1 | 452,00 \$ |
| 4065 527 | 400W Tel Kafes | 1 | 13,00 \$ |

Franko 300-250W

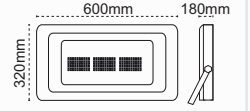

IP 65

| Kod No | Özellikler | Koli Adedi | Fiyat |
|-----------|---------------------|------------|-----------|
| 5617 1401 | 300W 4000K / 5000K | 1 | 340,00 \$ |
| 5617 1391 | 250W 4000K / 5000K | 1 | 255,00 \$ |
| 4065 526 | 300W-250W Tel Kafes | 1 | 13,00 \$ |

Franko 200W

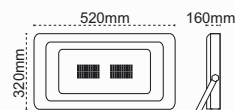

IP 65

| Kod No | Özellikler | Koli Adedi | Fiyat |
|-----------|--------------------|------------|-----------|
| 5617 1381 | 200W 4000K / 5000K | 1 | 177,00 \$ |
| 4065 525 | 200W Tel Kafes | 1 | 13,00 \$ |

Franko 150W

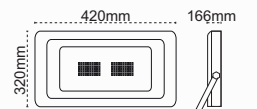

IP 65

| Kod No | Özellikler | Koli Adedi | Fiyat |
|-----------|------------------------------|------------|-----------|
| 5617 1371 | 150W 4000K / 5000K | 2 | 140,00 \$ |
| 5617 1372 | 150W 4000K / 5000K EU Driver | 2 | 160,00 \$ |
| 4065 524 | 150W Tel Kafes | 1 | 13,00 \$ |

Olimpiad 1000W-400w
Simetrik
Fiberglass

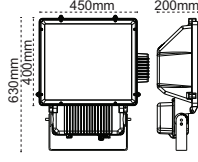

IP 65

| Kod No | Özellikler | Koli Adedi | Fiyat |
|-----------|--------------------|------------|-----------|
| 5611 1081 | 1000W Metal, MH/SB | 1 | 170,00 \$ |
| 5612 1062 | 400W Metal MH | 1 | 85,00 \$ |

Yeno 250-400W Simetrik
Fiberglass

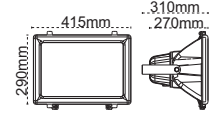

IP 65

| Kod No | Özellikler | Koli Adedi | Fiyat |
|-----------|------------------|------------|----------|
| 5611 1611 | 250W MH/SB HPI-T | 1 | 70,00 \$ |
| 5611 1613 | 400W SB SON-T | 2 | 78,00 \$ |
| 5611 1612 | 400W MH HPI-T | 2 | 73,00 \$ |

Euro 1000W Simetrik
Alüminyum Enjeksiyon

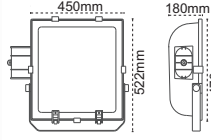

IP 65

| Kod No | Özellikler | Koli Adedi | Fiyat |
|-----------|---------------------|------------|-----------|
| 5611 2701 | 1000 W Metal, HPI-T | 1 | 378,00 \$ |

Tünel 250-400W
Alüminyum Enjeksiyon

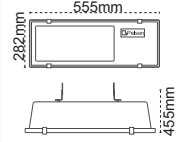

IP 65

| Kod No | Özellikler | Koli Adedi | Fiyat |
|-----------|----------------|------------|-----------|
| 5322 1011 | 250W MH/SB E40 | 1 | 147,00 \$ |
| 5322 1012 | 400W SB E40 | 1 | 153,00 \$ |

Elit Pesato 250-400W Asimetrik
Fiberglass

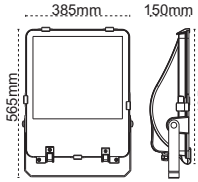

IP 65

| Kod No | Özellikler | Koli Adedi | Fiyat |
|-----------|------------------|------------|----------|
| 5611 1801 | 250W MH/SB HPI-T | 1 | 77,00 \$ |
| 5611 1802 | 400W MH HPI-T | 1 | 78,00 \$ |
| 5611 1803 | 400W SB SON-T | 1 | 83,00 \$ |

Elit Lirad 70-150W Simetrik
Fiberglass

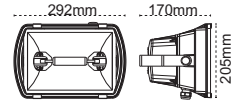

IP 65

| Kod No | Özellikler | Koli Adedi | Fiyat |
|-----------|-------------------|------------|----------|
| 5321 1901 | 70W MH/SB MHN-TD | 6 | 40,00 \$ |
| 5321 1902 | 150W MH/SB MHN-TD | 6 | 44,00 \$ |

Elit Semiad 70-150W Asimetrik
Fiberglass

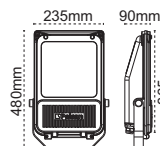

IP 65

| Kod No | Özellikler | Koli Adedi | Fiyat |
|-----------|-------------------|------------|----------|
| 5321 1801 | 70W MH/SB MHN-TD | 4 | 40,00 \$ |
| 5321 1802 | 150W MH/SB MHN-TD | 4 | 44,00 \$ |

Levo
Alüminyum Enjeksiyon

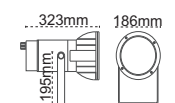

IP 65

| Kod No | Özellikler | Koli Adedi | Fiyat |
|-----------|------------------|------------|-----------|
| 5321 1711 | 70W Metal CDM-T | 4 | 58,75 \$ |
| 5321 1712 | 150W Metal CDM-T | 4 | 62,75 \$ |
| 5999 5071 | 25W Levo LED | 4 | 108,00 \$ |

Uzun Ömürlü, Yüksek Verimli Pelsan IP66 Wallwasher

- Çevre şartlarından etkilenmeyen IP66 alüminyum gövde
- Darbe dayanıklı, UV katkılı su geçirmez difüzör
- Ömrü boyunca sararma yapmayan PMMA Avrupa lens
- Avrupa LED çip
- Pelsan sabit akım driver
- Nem oluşumunu engelleyerek komponent ömrünü uzatan hava ventilli rakor



Işık
Hüzmesi

15°

30°

45°+20°

Ekstra Açısı ile
Homojen Işık Dağılımı

Hem kolon hem duvar aydınlatması

S.Ü. Wallwasher IP66 Inoaled 30 cm 12 LEDli

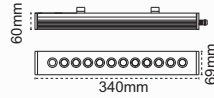

| Konfig | Renk | Fiyat |
|--------|---------|-----------|
| K172 | Mavi | +7,35 \$ |
| K170 | Yeşil | +7,35 \$ |
| K171 | Kırmızı | +7,35 \$ |
| K42 | Amber | +7,35 \$ |
| K69 | RGB | +56,60 \$ |

IP 66

| Kod No | Özellikler | 3000 / 4000 / 6500K | Koli Adedi | Fiyat |
|-----------|-------------------------|---------------------|------------|----------|
| 5614 1011 | 15W 15 Derece | 3000 / 4000 / 6500K | 4 | 47,10 \$ |
| 5614 1041 | 15W 30 Derece | 3000 / 4000 / 6500K | 4 | 47,10 \$ |
| 5614 1071 | 15W 45+20 Derece | 3000 / 4000 / 6500K | 4 | 47,10 \$ |
| 5614 1151 | Çift Modül 30W 24 LEDli | 3000 / 4000 / 6500K | 4 | 59,00 \$ |

S.Ü. Wallwasher IP66 Inoaled 60 cm 24 LEDli

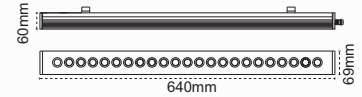

| Konfig | Renk | Fiyat |
|--------|---------|----------|
| K172 | Mavi | +14,70\$ |
| K170 | Yeşil | +14,70\$ |
| K171 | Kırmızı | +14,70\$ |
| K42 | Amber | +14,70\$ |
| K69 | RGB | +64,90\$ |

IP 66

| Kod No | Özellikler | 3000 / 4000 / 6500K | Koli Adedi | Fiyat |
|-----------|-------------------------|---------------------|------------|-----------|
| 5614 1021 | 30W 15 Derece | 3000 / 4000 / 6500K | 4 | 75,40 \$ |
| 5614 1051 | 30W 30 Derece | 3000 / 4000 / 6500K | 4 | 75,40 \$ |
| 5614 1081 | 30W 45+20 Derece | 3000 / 4000 / 6500K | 4 | 75,40 \$ |
| 5614 1161 | Çift Modül 60W 48 LEDli | 3000 / 4000 / 6500K | 4 | 109,00 \$ |

S.Ü. Wallwasher IP66 Inoaled 90 cm 36 LEDli

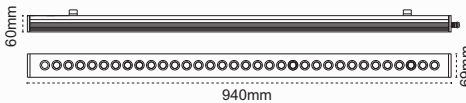

| Konfig | Renk | Fiyat |
|--------|---------|-----------|
| K172 | Mavi | +22,00 \$ |
| K170 | Yeşil | +22,00 \$ |
| K171 | Kırmızı | +22,00 \$ |
| K42 | Amber | +22,00 \$ |
| K69 | RGB | +88,90 \$ |

IP 66

| Kod No | Özellikler | 3000 / 4000 / 6500K | Koli Adedi | Fiyat |
|-----------|-------------------------|---------------------|------------|-----------|
| 5614 1031 | 45W 15 Derece | 3000 / 4000 / 6500K | 4 | 113,10 \$ |
| 5614 1061 | 45W 30 Derece | 3000 / 4000 / 6500K | 4 | 113,10 \$ |
| 5614 1091 | 45W 45+20 Derece | 3000 / 4000 / 6500K | 4 | 113,10 \$ |
| 5614 1171 | Çift Modül 90W 72 LEDli | 3000 / 4000 / 6500K | 4 | 139,00 \$ |

S.Ü. Wallwasher IP66 Inoaled 120 cm 48 LEDli

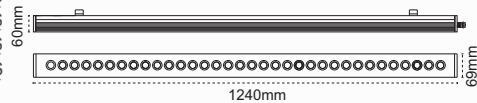

| Konfig | Renk | Fiyat |
|--------|---------|------------|
| K172 | Mavi | +29,40 \$ |
| K170 | Yeşil | +29,40 \$ |
| K171 | Kırmızı | +29,40 \$ |
| K42 | Amber | +29,40 \$ |
| K69 | RGB | +112,90 \$ |

IP 66

| Kod No | Özellikler | 3000 / 4000 / 6500K | Koli Adedi | Fiyat |
|-----------|------------------|---------------------|------------|-----------|
| 5614 1121 | 45W 45+20 Derece | 3000 / 4000 / 6500K | 4 | 130,00 \$ |

Yeni
Ürün

Talin

**3 Farklı Güç, 3 Farklı Boyut.
Şimdi Daha Hesaplı!**

- Alüminyum enjeksiyon gövde
- Toz ve su almaz, IP65
- Darbelere dayanıklı IK08



Talin

Yeni
Ürün



axbxc mm
30W:355x125x55
50W:405x165x55
100W:620x220x75

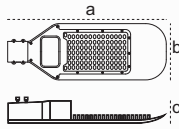

| Kod No | Özellikler | Koli Adedi | Fiyat |
|-----------|------------|------------|-----------|
| 5615 5851 | 30W 4000K | 15 | 47,15 \$ |
| 5615 5861 | 50W 4000K | 10 | 66,00 \$ |
| 5615 5871 | 100W 4000K | 4 | 141,35 \$ |

Bari

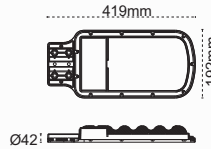

| Kod No | Özellikler | Koli Adedi | Fiyat |
|-----------|------------|------------|----------|
| 5615 5811 | 42W 4000K | 2 | 82,50 \$ |

Lizbon

Yeni
Ürün

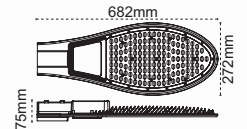

| Kod No | Özellikler | Koli Adedi | Fiyat |
|-----------|------------|------------|-----------|
| 5615 5741 | 150W 4000K | 2 | 212,00 \$ |

Lima

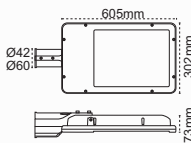

| Kod No | Özellikler | Koli Adedi | Fiyat |
|-----------|-------------------|------------|-----------|
| 5615 6781 | 103W 4000 / 6500K | 1 | 375,00 \$ |
| 5615 6782 | 154W 4000 / 6500K | 1 | 431,00 \$ |
| 5615 6783 | 180W 4000 / 6500K | 1 | 489,00 \$ |

Tokyo / Tokyo MED

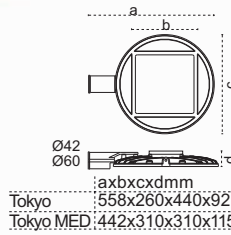

| Kod No | Özellikler | Koli Adedi | Fiyat |
|-----------|-------------------|------------|-----------|
| 5616 3841 | 77W 4000 / 6500K | 1 | 281,00 \$ |
| 5616 3861 | 103W 4000 / 6500K | 1 | 356,00 \$ |
| 5616 3871 | 39W 4000 / 6500K | 1 | 187,00 \$ |
| 5616 3872 | 59W 4000 / 6500K | 1 | 196,00 \$ |

Seul LED

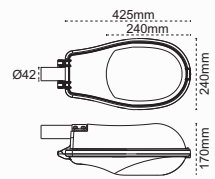

| Kod No | Özellikler | Koli Adedi | Fiyat |
|-----------|------------|------------|----------|
| 5615 6801 | 30W 4000K | 10 | 66,00 \$ |

Rio

**TEDAŞ
Şartnamelerine
Uygun**



M1 - M2 - M3 - M4 - M5 yol sınıflarına uygun.

Otomatik dim programlama opsiyonu ile ayarlanabilir ışık seviyesi

- Avrupa LED çip ve Avrupa driver
- 120 lm/W Etkinlik Faktörü
- 45W'dan 240W'a kadar güç seçeneği
- 0° - 5° - 10° - 15° ayarlanabilir konsol
- -40 / +50 °C ortam koşulunda çalışır
- Toz ve su almaz, IP66
- Darbelere dayanıklı IK09

Rio IP66 120 LEDli

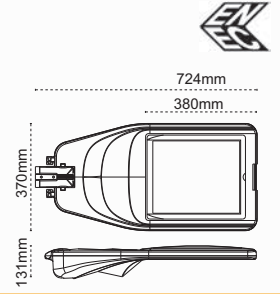

IP 66 ⊕

| Kod No | Özellikler | Koli Adedi | Fiyat |
|-----------|-----------------------------|------------|-----------|
| 5616 5791 | 200W 120 LEDli 4000 / 6500K | 1 | 494,00 \$ |
| 5616 5721 | 240W 120 LEDli 4000 / 6500K | 1 | 538,00 \$ |

Rio IP66 80 LEDli

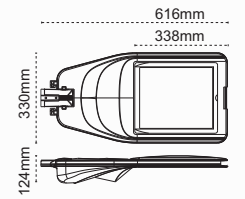

IP 66 ⊕

| Kod No | Özellikler | Koli Adedi | Fiyat |
|-----------|----------------------------|------------|-----------|
| 5616 5751 | 100W 80 LEDli 4000 / 6500K | 1 | 329,00 \$ |
| 5616 5741 | 140W 80 LEDli 4000 / 6500K | 1 | 373,00 \$ |

Rio IP66 36 LEDli

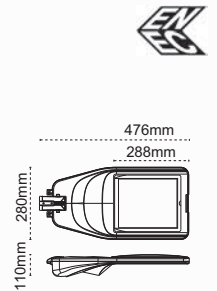

IP 66 ⊕

| Kod No | Özellikler | Koli Adedi | Fiyat |
|-----------|---------------------------|------------|-----------|
| 5616 5611 | 45W 36 LEDli 4000 / 6500K | 1 | 208,00 \$ |
| 5616 5621 | 65W 36 LEDli 4000 / 6500K | 1 | 230,00 \$ |

TEDAŞ
Şartnamelerine
Uygun



- Toz ve su almaz, IP66
- Polimer enjeksiyon gövde
- Darbelere dayanıklı IK08 koruma sınıfına sahip temperli cam
- 42 – 60 mm çaplı alttan veya yandan montaja uygun giriş konsolu
- Isıl anahtarlı, bakır sargılı balast
- Gün ışığına duyarlı fotosel uygulaması

Roma Polimer Enjeksiyon

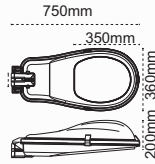

IP 66

| Kod No | Özellikler | Koli Adedi | Fiyat |
|-----------|---------------|------------|----------|
| 5211 6313 | 250W SB SON-T | 1 | 86,00 \$ |
| 5211 6314 | 400W SB SON-T | 1 | 94,50 \$ |

Sofia Polimer Enjeksiyon

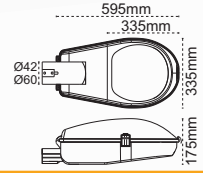

IP 65

| Kod No | Özellikler | Koli Adedi | Fiyat |
|-----------|--------------------------|------------|----------|
| 5211 6211 | Sofia 100 W Sodyum SON-T | 2 | 49,50 \$ |
| 5211 6212 | Sofia 150 W Sodyum SON-T | 2 | 55,50 \$ |

Riga Polimer Enjeksiyon

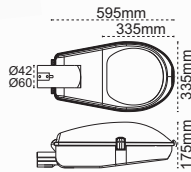

IP 65

| Kod No | Özellikler | Koli Adedi | Fiyat |
|-----------|------------------------|------------|----------|
| 5211 6011 | Riga 50 W Sodyum SON-T | 2 | 41,50 \$ |
| 5211 6012 | Riga 70 W Sodyum SON-T | 2 | 44,00 \$ |

Seul Polimer Enjeksiyon

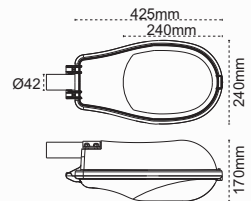

IP 65

| Kod No | Özellikler | Koli Adedi | Fiyat |
|-----------|-------------|------------|----------|
| 5211 6411 | 65W Boş PLE | 5 | 11,60 \$ |

Lyon Alüminyum Enjeksiyon

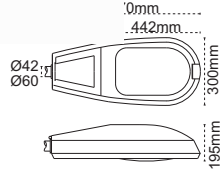

IP 65 / 43 ☺

| Kod No | Özellikler | Koli Adedi | Fiyat |
|-----------|--------------------|------------|-----------|
| 5211 5011 | 100 W Sodyum SON-T | 1 | 125,50 \$ |
| 5211 5012 | 150 W Sodyum SON-T | 1 | 129,50 \$ |
| 5211 5013 | 250 W Sodyum SON-T | 1 | 133,50 \$ |
| 5211 5014 | 400 W Sodyum SON-T | 1 | 137,50 \$ |

Bakü Temperli Camlı Alüminyum

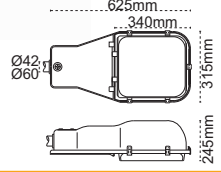

IP 65 / 43 ☺

| Kod No | Özellikler | Koli Adedi | Fiyat |
|-----------|-------------------|------------|----------|
| 5211 1613 | 150W Sodyum SON-T | 1 | 82,50 \$ |
| 5211 1614 | 250W Sodyum SON-T | 1 | 90,50 \$ |
| 5211 1616 | 400W Sodyum SON-T | 1 | 94,50 \$ |

Parma Alüminyum

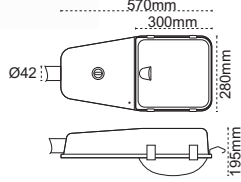

IP 54 / 43 ☺

| Kod No | Özellikler | Koli Adedi | Fiyat |
|-----------|-------------------|------------|----------|
| 5211 1010 | 160W Boş ML | 5 | 35,50 \$ |
| 5211 1014 | 150W Sodyum SON-T | 5 | 64,50 \$ |

Ibiza Fiberglass

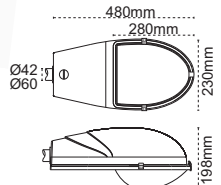

IP 54 / 43 ☺

| Kod No | Özellikler | Koli Adedi | Fiyat |
|-----------|--------------|------------|----------|
| 5211 3242 | 85 W Boş PLE | 5 | 18,50 \$ |
| 5211 3240 | 160 W Boş ML | 5 | 18,50 \$ |
| 5211 3244 | 70 W Son-T | 5 | 38,50 \$ |

Corfu Fiberglass

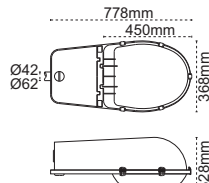

IP 54 / 43 ☺

| Kod No | Özellikler | Koli Adedi | Fiyat |
|-----------|-------------------|------------|----------|
| 5211 1110 | 250W Boş ML | 1 | 41,50 \$ |
| 5211 1115 | 250W Sodyum SON-T | 1 | 69,50 \$ |
| 5211 1118 | 400W Sodyum SON-T | 1 | 79,50 \$ |

Konsollar

IP 40 ☺

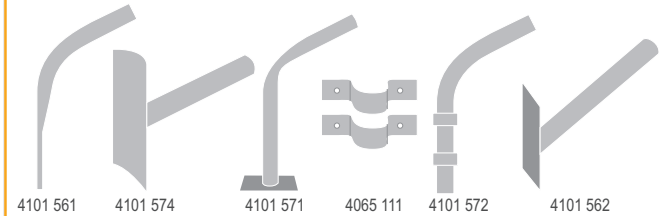

| Kod No | Özellikler | Koli Adedi | Fiyat |
|----------|---------------------------------|------------|---------|
| 4101 561 | | | |
| 4101 574 | | | |
| 4101 571 | | | |
| 4065 111 | | | |
| 4101 572 | | | |
| 4101 562 | | | |
| 4101 551 | Konsol Boru 60cm | 25 | 4,40 \$ |
| 4101 561 | Duvar Tipi Konsol Boru 60cm Ø42 | 25 | 6,60 \$ |
| 4101 574 | Ø60 Direk Tipi Konsol Boru | 1 | 8,00 \$ |
| 4101 571 | Set Üstü Konsol 60cm | 1 | 8,00 \$ |
| 4101 572 | Kelepçeli Konsol | 1 | 6,60 \$ |
| 4101 562 | Duvar Tipi Konsol Boru 30cm Ø42 | 1 | 8,00 \$ |
| 3035 451 | 60/42 Konsol Adaptörü | 1 | 8,60 \$ |
| 4065 111 | Boru Kelepçe | 1 | 1,75 \$ |

Rio Solar

Doğadan Gelen Güç!

- Enerji hatlarının bulunmadığı mekanlara ekonomik çözüm
- Gün içinde depoladığı enerji ile 2 gün aydınlatma
- Komple sistem çözümü

Rio Solar

| Kod No | Özellikler | Koli Adedi | Fiyat |
|-----------|-----------------------------|------------|-----------|
| 5616 5651 | 20W 36 LEDli Sokak Armatürü | 1 | 209,00 \$ |
| 5616 5661 | 40W 36 LEDli Sokak Armatürü | 1 | 229,00 \$ |

Rio Solar Armatür

- ▶ Avrupa LED Çip
- ▶ Yüksek verimli driver
- ▶ Avrupa lens

Rio Solar Sistem

| Kod No | Özellikler | Koli Adedi | Fiyat |
|-----------|-----------------------------------|------------|------------|
| 5616 5671 | 20W Solar Sistem (Armatür-Sistem) | 1 | 1078,00 \$ |
| 5616 5681 | 40W Solar Sistem (Armatür-Sistem) | 1 | 1778,00 \$ |

Solar Panel

- ▶ Yüksek verimli monokristal panel
- ▶ Çevre şartlarına dayanımlı IP65 terminal kutusu
- ▶ Güneşi toplayan özel yüzey
- ▶ Kendisini temizleyen, kir tutmayan panel dokusu
- ▶ Yaşlanmaya karşı EVA film koruma

Batarya

- ▶ Uzun ömürlü, bakım gerektirmeyen JEL batarya
- ▶ Düşük iç direnci sayesinde yüksek performans
- ▶ Çevre şartlarına dayanımlı yapı

Solar Şarj Cihazı

- ▶ Özel yazılımı ile en ideal şarj modunu seçer.
- ▶ Voltaj - akım kontrolü sağlar, sistem ömrünü uzatır.
- ▶ Solar panelden gelen akımı kontrol eder. Akü ömrünü uzatır.

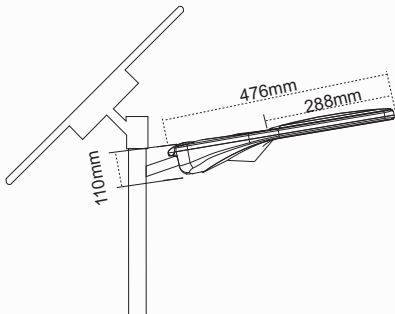

Soho

**Park Bahçe
Yönetmeliğine
Uygun**

- Gece 2'den sonra otomatik %50 dim opsiyonu
- Avrupa LED Çip , Avrupa driver
- Modüler Tasarım

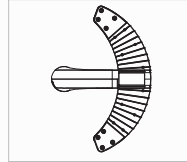

Soho 1
Tekli Modül Montaj

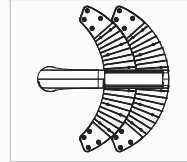

Soho 2
İkili Modül Montaj

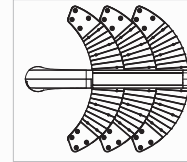

Soho 3
Üçlü Modül Montaj

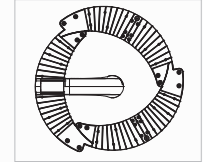

Soho 4
Üçlü Modül Montaj

| | |
|------------------------------|----------------|
| IP Sınıfı | IP65 |
| Gövde | Alüminyum |
| Önerilen Uygulama Yüksekliği | 4 - 6 m |
| LED Çip | Avrupa LED Çip |
| LED Driver | Avrupa Driver |
| Konsol Çapı | 76 mm |

Zaman Ayarı Opsiyonu

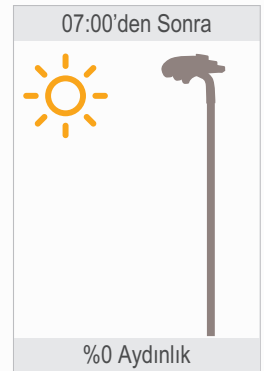

Soho

IP 65 ☺

| Kod No | Özellikler | Koli Adedi | Fiyat |
|-----------|--|------------|-----------|
| 5714 1501 | Soho 1 25W LED 4000 / 6500K 4m direkli | 1 | 575,00 \$ |
| 5714 1521 | Soho 2 50W LED 4000 / 6500K 4m direkli | 1 | 630,00 \$ |
| 5714 1541 | Soho 3 75W LED 4000 / 6500K 4m direkli | 1 | 690,00 \$ |
| 5714 1561 | Soho 4 75W LED 4000 / 6500K 4m direkli | 1 | 660,00 \$ |

Evaled

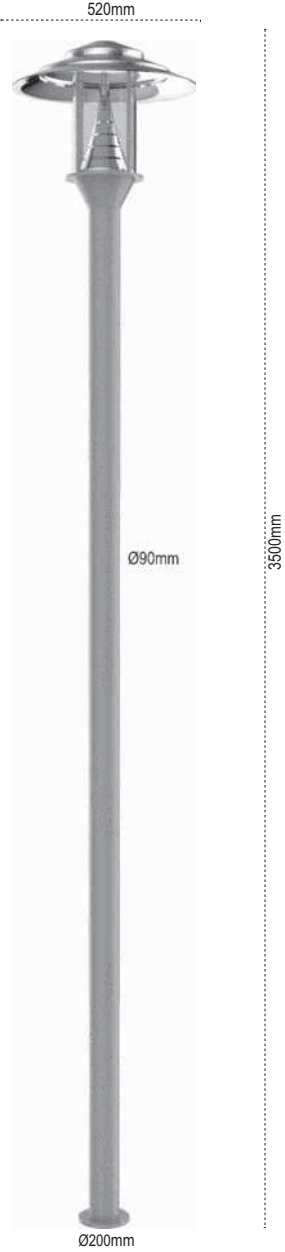

IP 54 ☺

| Kod No | Özellikler | Koli Adedi | Fiyat |
|-----------|------------|------------|-----------|
| 5711 3061 | 40W LEDli | 1 | 378,00 \$ |

Mesaled

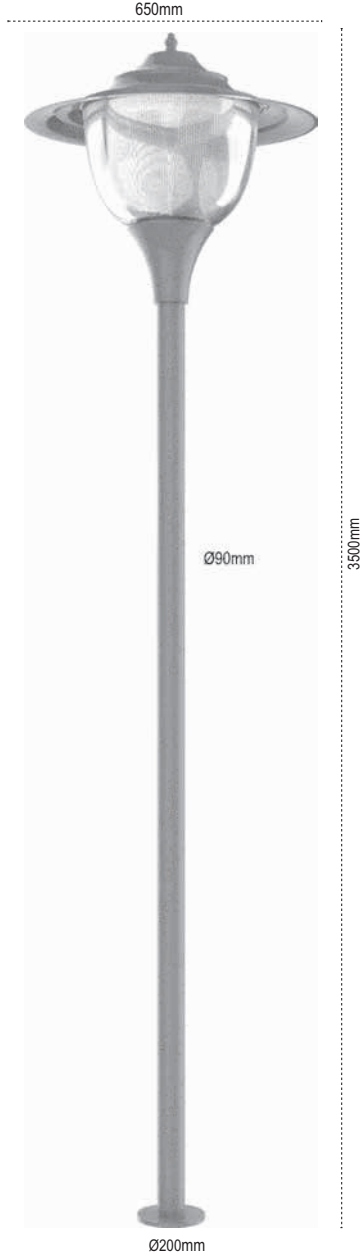

IP 54 ☺

| Kod No | Özellikler | Koli Adedi | Fiyat |
|-----------|----------------|------------|-----------|
| 5711 3081 | 30W LEDli | 1 | 283,00 \$ |
| 5711 3091 | 60W LEDli | 1 | 305,00 \$ |
| 5711 3101 | 60 / 30W LEDli | 1 | 340,00 \$ |

Datça

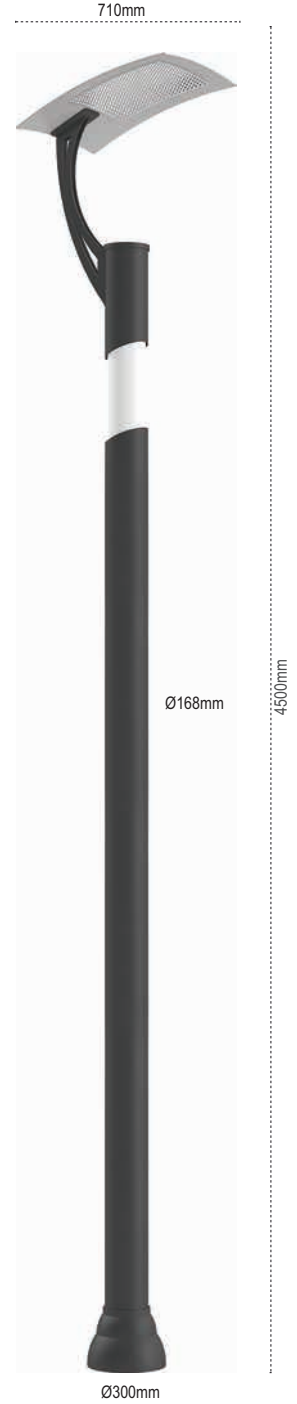

IP 65 ☺

| Kod No | Özellikler | Koli Adedi | Fiyat |
|-----------|--------------------|------------|-----------|
| 5723 1011 | 150W G12 | 1 | 494,00 \$ |
| 5723 0810 | 30W LEDli | 1 | 672,00 \$ |
| 5985 9810 | RGB Kontrol Cihazı | 1 | 20,40 \$ |

LEDli Park Bahçe Aydınlatma Armatürleri

Limra LED

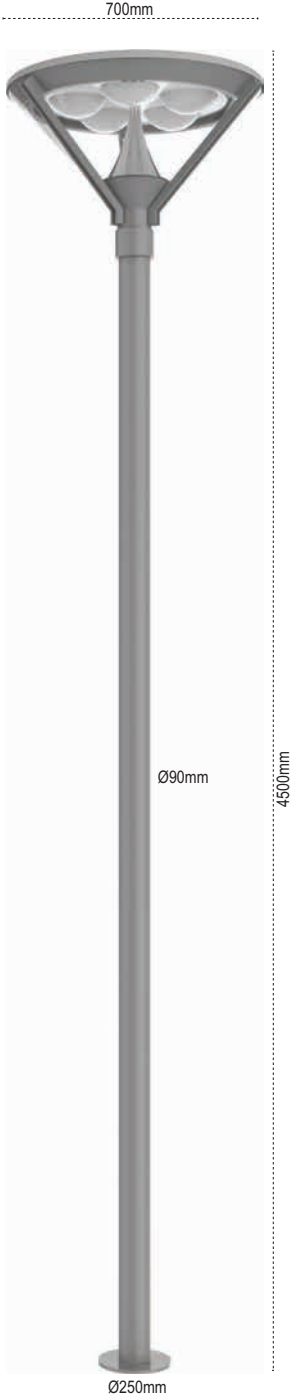

IP 54

| Kod No | Özellikler | Koli Adedi | Fiyat |
|-----------|-------------|------------|-----------|
| 5711 2632 | 150W E40 | 1 | 410,00 \$ |
| 5711 3051 | 38W 3 LEDli | 1 | 525,00 \$ |
| 5711 3021 | 80W 5 LEDli | 1 | 614,00 \$ |

Patras LED

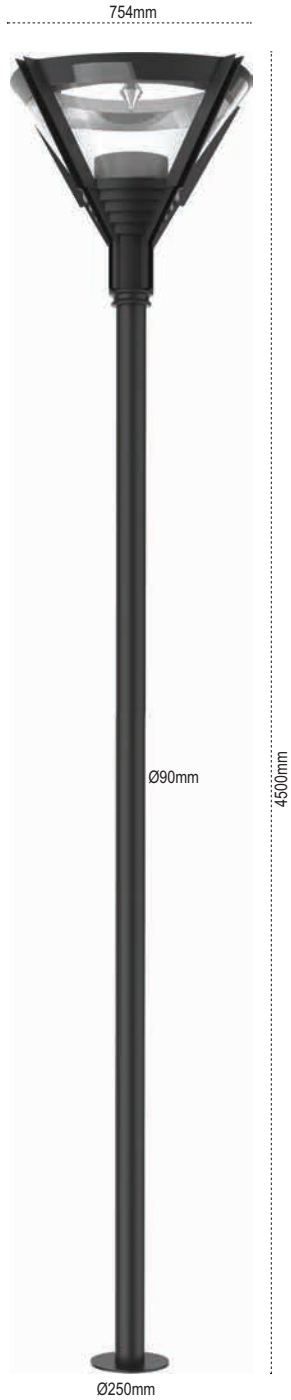

IP 65

| Kod No | Özellikler | Koli Adedi | Fiyat |
|-----------|------------|------------|-----------|
| 5740 1031 | 150W Rx7S | 1 | 614,00 \$ |
| 5615 6824 | 68W LEDli | 1 | 650,00 \$ |

Verde

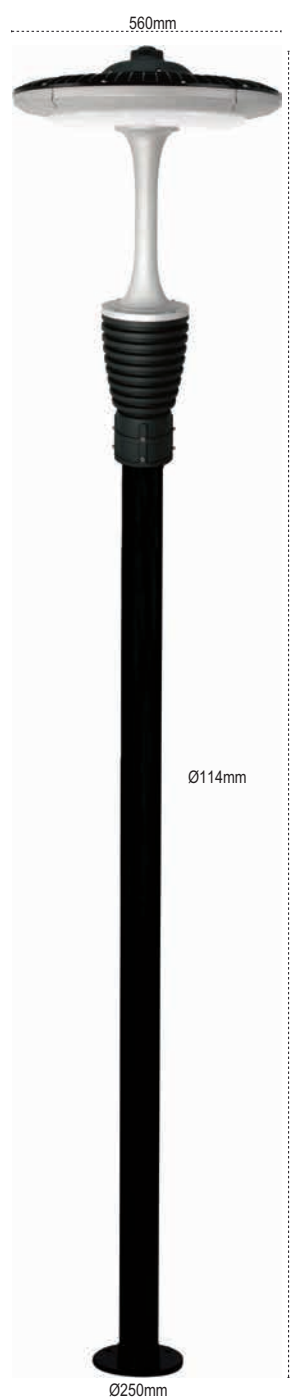

IP 65

| Kod No | Özellikler | Koli Adedi | Fiyat |
|-----------|-----------------|------------|-----------|
| 5616 5411 | 68W LEDli 6500K | 1 | 659,00 \$ |

Samos

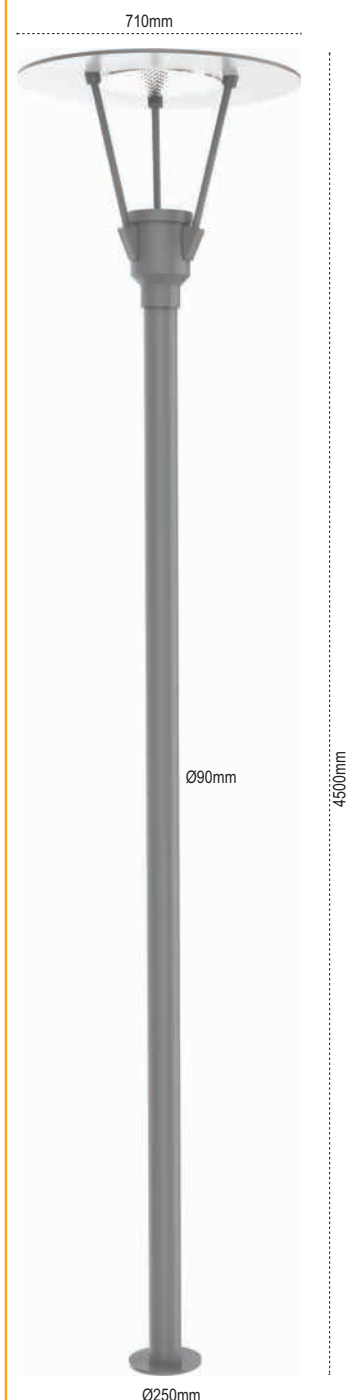

IP 65

| Kod No | Özellikler | Koli Adedi | Fiyat |
|-----------|-------------|------------|-----------|
| 5740 1321 | 150W G12 | 1 | 451,00 \$ |
| 5740 1330 | 50W COB LED | 1 | 529,00 \$ |

Pelsan LEDli Park Bahçe Aydınlatma Armatürleri

Olimpos R



Size özel Olimpos tasarımlar için satış temsilcimize danışınız.

IP 65

| Kod No | Özellikler | Koli Adedi | Fiyat |
|-----------|------------|------------|-----------|
| 5714 1371 | 75W LEDli | 1 | 755,00 \$ |
| 5714 1381 | 50W LEDli | 1 | 695,00 \$ |

Olimpos T

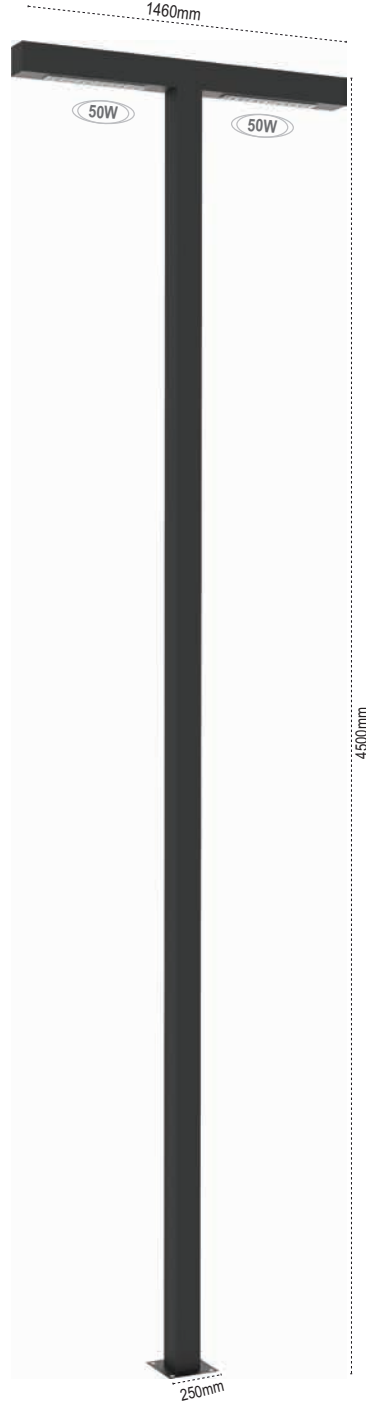

Size özel Olimpos tasarımlar için satış temsilcimize danışınız.

IP 65

| Kod No | Özellikler | Koli Adedi | Fiyat |
|-----------|------------|------------|-----------|
| 5714 1391 | 100W LEDli | 1 | 815,00 \$ |

Olimpos T

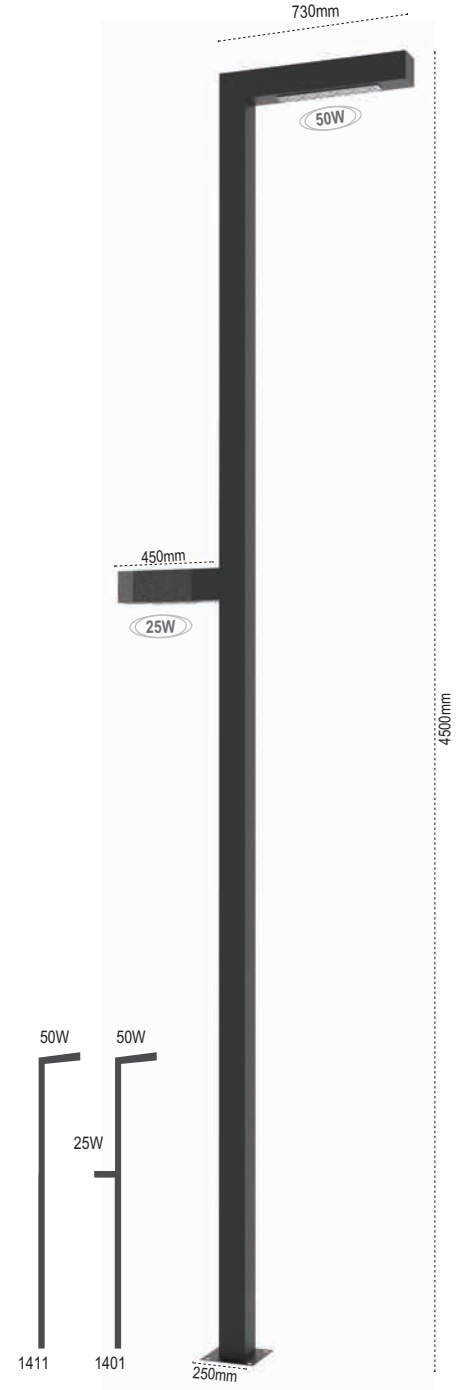

Size özel Olimpos tasarımlar için satış temsilcimize danışınız.

IP 65

| Kod No | Özellikler | Koli Adedi | Fiyat |
|-----------|------------|------------|-----------|
| 5714 1401 | 75W LEDli | 1 | 755,00 \$ |
| 5714 1411 | 50W LEDli | 1 | 695,00 \$ |

LEDli Park Bahçe Aydınlatma Armatürleri

Alinda

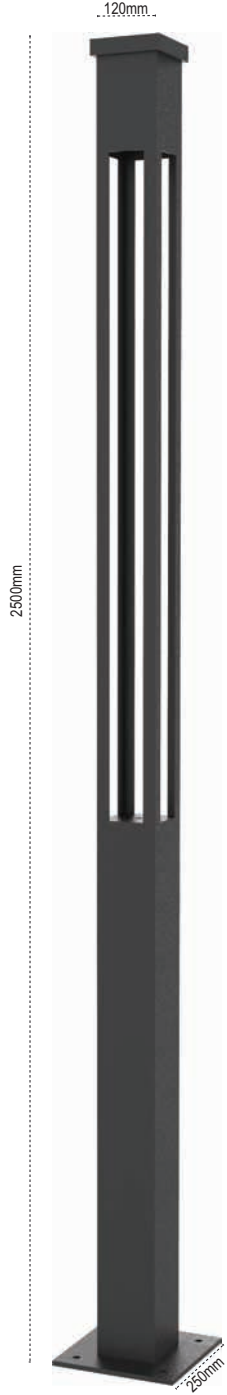

IP 65

| Kod No | Özellikler | Koli Adedi | Fiyat |
|-----------|------------|------------|-----------|
| 5714 1311 | 25W LEDli | 1 | 510,00 \$ |

Assos

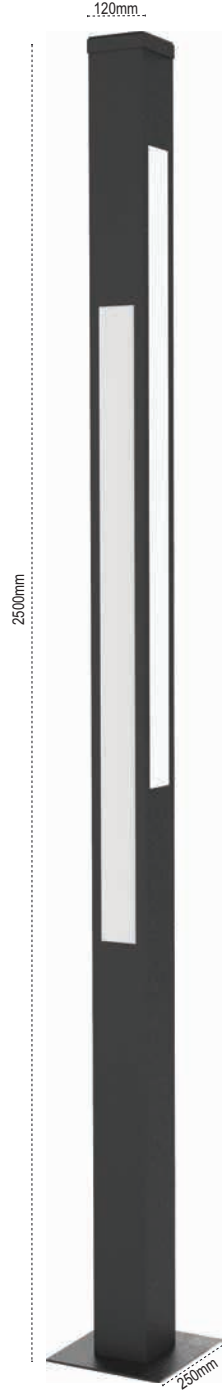

IP 65

| Kod No | Özellikler | Koli Adedi | Fiyat |
|-----------|------------|------------|-----------|
| 5714 1321 | 100W LEDli | 1 | 650,00 \$ |

Milas

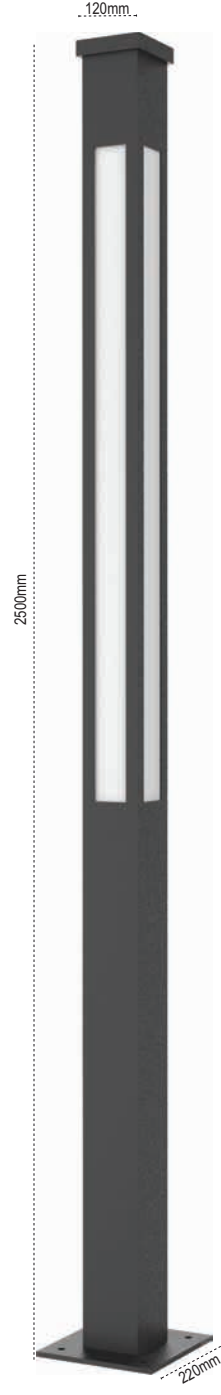

IP 65

| Kod No | Özellikler | Koli Adedi | Fiyat |
|-----------|------------|------------|-----------|
| 5615 4731 | 100W LEDli | 1 | 570,00 \$ |

Patara



IP 65

| Kod No | Özellikler | Koli Adedi | Fiyat |
|-----------|------------|------------|-----------|
| 5714 1351 | 125W LEDli | 1 | 650,00 \$ |

Pelsan LEDli Park Bahçe Aydınlatma Armatürleri

Milet

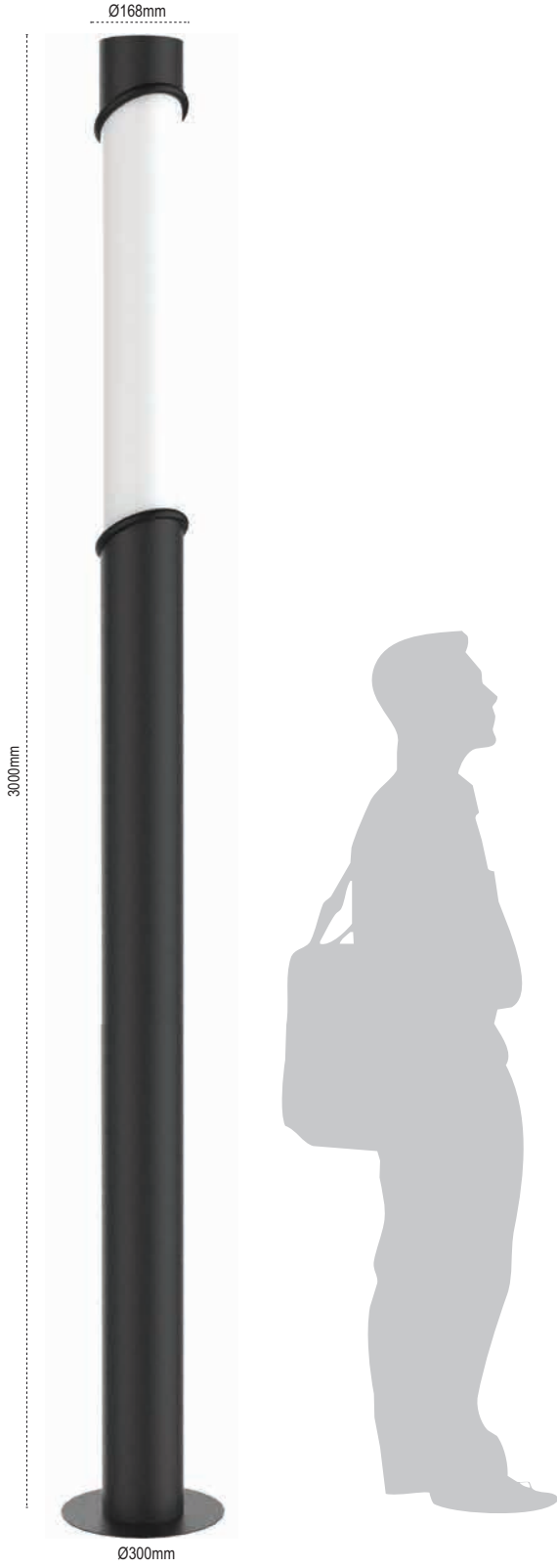

IP 65

| Kod No | Özellikler | Koli Adedi | Fiyat |
|-----------|------------|------------|-----------|
| 5615 4761 | 40W LEDli | 1 | 475,00 \$ |

Bitez



IP 65

| Kod No | Özellikler | Koli Adedi | Fiyat |
|-----------|------------|------------|-----------|
| 5615 4711 | 100W LEDli | 1 | 410,00 \$ |

Temi

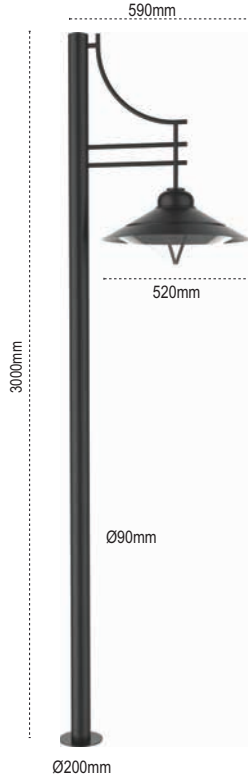

IP 54

| Kod No | Özellikler | Koli Adedi | Fiyat |
|-----------|----------------|------------|-----------|
| 5715 1260 | Temi Direk E27 | 1 | 119,00 \$ |

Ruso

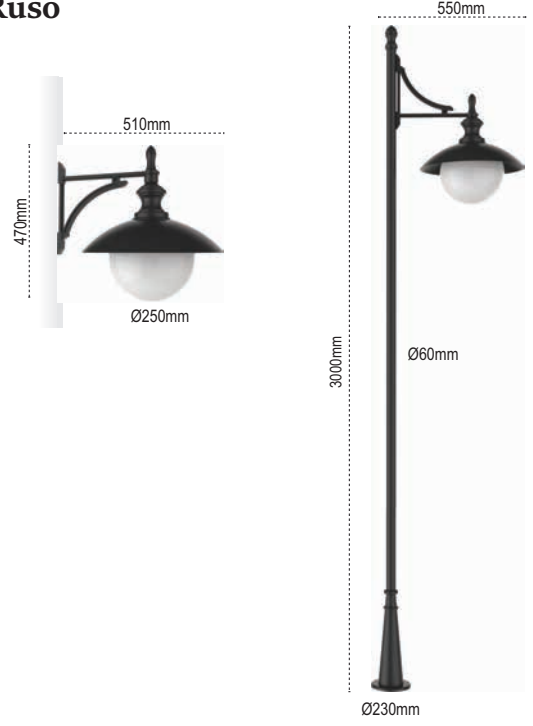

IP 54

| Kod No | Özellikler | Koli Adedi | Fiyat |
|-----------|----------------------------------|------------|-----------|
| 5714 1200 | Ruso Tekli Döküm Dipli Direk E27 | 1 | 199,00 \$ |
| 5714 1210 | Ruso İkili Döküm Dipli Direk E27 | 1 | 266,00 \$ |
| 5711 1670 | Ruso Duvar Aplik E27 | 1 | 66,00 \$ |

Açelya



IP 54

| Kod No | Özellikler | Koli Adedi | Fiyat |
|-----------|---------------------------|------------|----------|
| 5730 1730 | Açelya Fener Aplik E27 | 10 | 13,65 \$ |
| 5730 1740 | Açelya Fener Set Üstü E27 | 10 | 13,65 \$ |

Karo



IP 54

| Kod No | Özellikler | Koli Adedi | Fiyat |
|-----------|-------------------------|------------|----------|
| 5730 1610 | Karo Fener Aplik E27 | 10 | 13,65 \$ |
| 5730 1620 | Karo Fener Set Üstü E27 | 10 | 13,65 \$ |

Perge



IP 54

| Kod No | Özellikler | Koli Adedi | Fiyat |
|-----------|----------------------|------------|-----------|
| 5716 1110 | Perge Direk Arm. E27 | 1 | 137,00 \$ |
| 5718 1720 | Perge Çimen Arm. E27 | 1 | 63,00 \$ |
| 5711 1180 | Perge Aplik E27 | 1 | 63,00 \$ |

Uruse

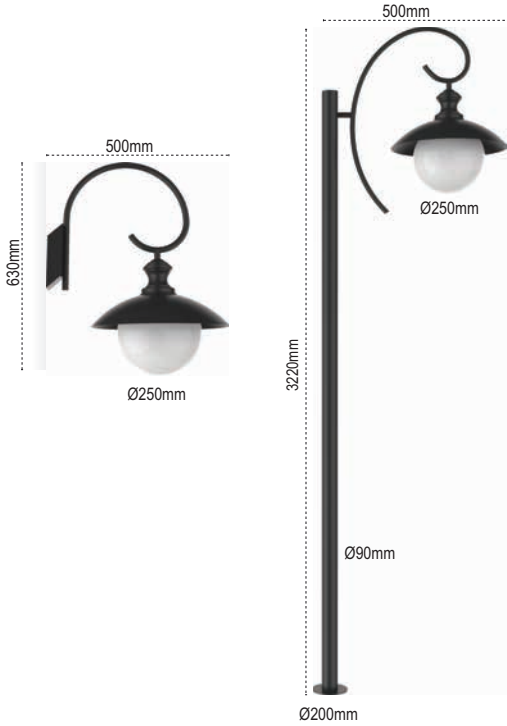

IP 54

| Kod No | Özellikler | Koli Adedi | Fiyat |
|-----------|-----------------------|------------|-----------|
| 5714 1420 | Uruse Boru Direk E27 | 1 | 131,00 \$ |
| 5711 1790 | Uruse Duvar Aplik E27 | 1 | 69,00 \$ |

Pedesa

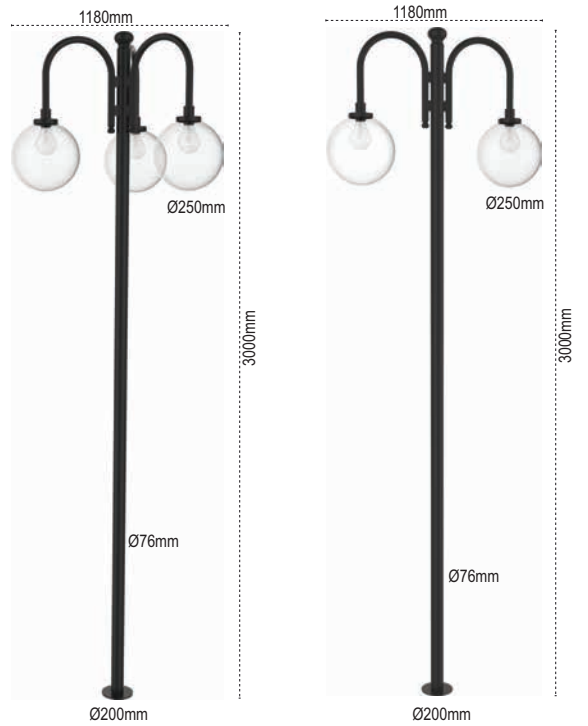

IP 54

| Kod No | Özellikler | Koli Adedi | Fiyat |
|-----------|----------------------------------|------------|-----------|
| 5715 3060 | Pedesa Şeffaf 1 Gloplu Direk E27 | 1 | 100,00 \$ |
| 5715 1060 | Pedesa Şeffaf 2 Gloplu Direk E27 | 1 | 168,00 \$ |
| 5715 1370 | Pedesa Şeffaf 3 Gloplu Direk E27 | 1 | 236,00 \$ |

Antalya (Alüminyum)

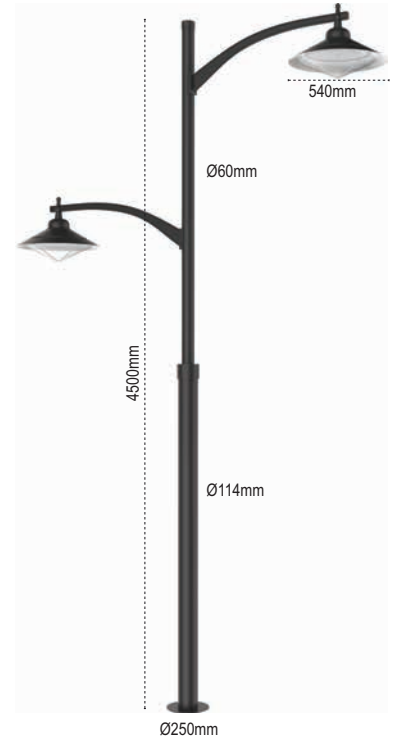
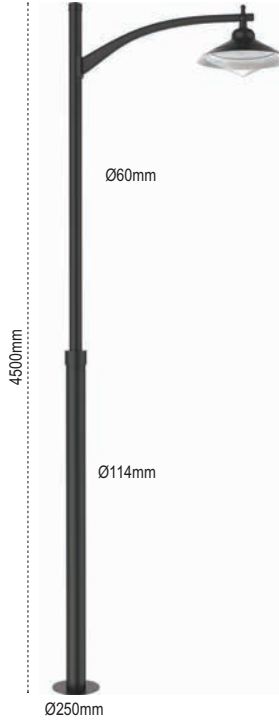

IP 54

| Kod No | Özellikler | Koli Adedi | Fiyat |
|-----------|------------------------|------------|-----------|
| 5715 1380 | Antalya 1'li Direk E27 | 1 | 192,00 \$ |
| 5715 1390 | Antalya 2'li Direk E27 | 1 | 244,00 \$ |
| 5718 1850 | Antalya Çimen Arm. E27 | 1 | 107,00 \$ |
| 5711 2300 | Antalya Aplik E27 | 1 | 79,00 \$ |

Eva

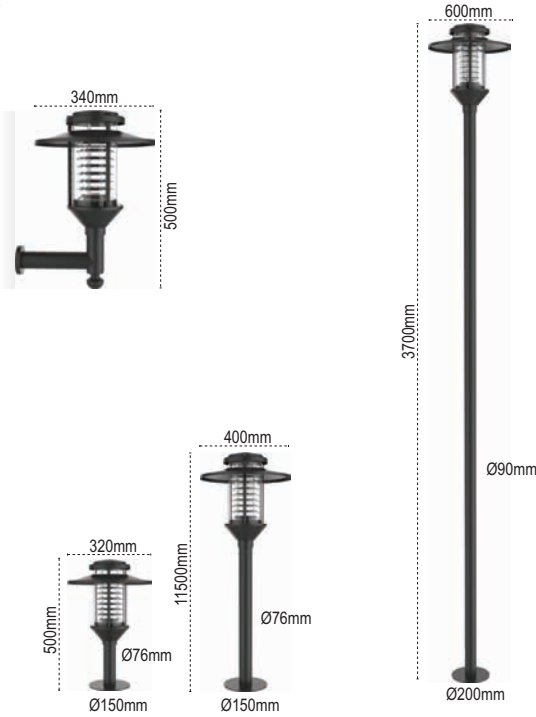

Arta



IP 54

| Kod No | Özellikler | Koli Adedi | Fiyat |
|-----------|-------------------------|------------|-----------|
| 5715 1290 | Eva Boru Direk Arm. E27 | 1 | 203,00 \$ |
| 5718 1310 | Eva Çimen Arm. E27 | 1 | 116,00 \$ |
| 5712 1340 | Eva Set Üstü E27 | 1 | 116,00 \$ |
| 5711 2510 | Eva Aplik E27 | 1 | 116,00 \$ |

IP 54

| Kod No | Özellikler | Koli Adedi | Fiyat |
|-----------|--------------------------|------------|-----------|
| 5719 1110 | Arta Boru Direk Arm. E27 | 1 | 203,00 \$ |
| 5718 1430 | Arta Boru Çimen Arm. E27 | 1 | 116,00 \$ |
| 5712 1220 | Arta Boru Set Üstü E27 | 1 | 116,00 \$ |
| 5711 2500 | Arta Aplik E27 | 1 | 116,00 \$ |

Milas

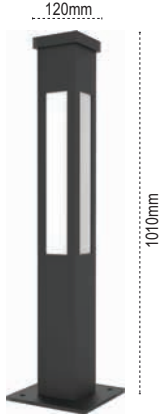

IP 54

| Kod No | Özellikler | Koli Adedi | Fiyat |
|-----------|------------------------------|------------|-----------|
| 5718 1710 | Milas Çimen Armatürü E27 | 1 | 121,00 \$ |
| 5718 1730 | Milas LED Çimen Armatürü 20W | 1 | 189,00 \$ |

Milet - Arta



5615 4721



5718 1430

IP 54

| Kod No | Özellikler | Koli Adedi | Fiyat |
|-----------|------------------------------|------------|-----------|
| 5615 4721 | Milet LEDli Çimen Armatürü | 1 | 221,00 \$ |
| 5718 1430 | Arta Boru Çimen Armatürü E27 | 1 | 116,00 \$ |

Briled



5730 4680

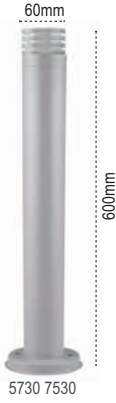

5730 7530



5730 4670

IP 54

| Kod No | Özellikler | Koli Adedi | Fiyat |
|-----------|-------------------------|------------|----------|
| 5730 4680 | 5W Aplik 4000K | 6 | 30,00 \$ |
| 5730 7530 | 5W Çimen Armatürü 4000K | 6 | 55,00 \$ |
| 5730 4670 | 2x5W Aplik 4000K | 6 | 38,00 \$ |

Noa - Fia



5718 1580



5718 1250

IP 54

| Kod No | Özellikler | Koli Adedi | Fiyat |
|-----------|------------------------|------------|-----------|
| 5718 1580 | Noa Çimen Armatürü E27 | 1 | 79,00 \$ |
| 5718 1250 | Fia Çimen Armatürü E27 | 1 | 116,00 \$ |

Pedesa - Perge

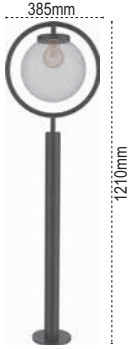

5718 1330



5718 1720

IP 54

| Kod No | Özellikler | Koli Adedi | Fiyat |
|-----------|---------------------------|------------|----------|
| 5718 1330 | Pedesa Çimen Armatürü E27 | 1 | 63,00 \$ |
| 5718 1720 | Perge Çimen Armatürü E27 | 1 | 63,00 \$ |

Eva

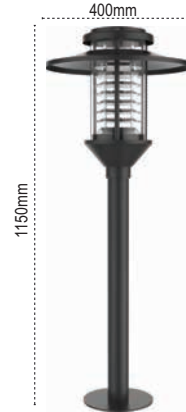

IP 54

| Kod No | Özellikler | Koli Adedi | Fiyat |
|-----------|------------------------|------------|-----------|
| 5718 1310 | Eva Çimen Armatürü E27 | 1 | 116,00 \$ |

Mezzo

Alüminyum
Enjeksiyon

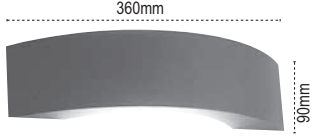

IP 54

| Kod No | Özellikler | Koli Adedi | Fiyat |
|-----------|--------------|------------|----------|
| 5616 3310 | 6W LED 3000K | 6 | 47,30 \$ |
| 5616 3340 | 9W LED 3000K | 10 | 51,60 \$ |

Cono

Alüminyum
Enjeksiyon

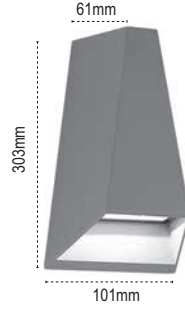

IP 54

| Kod No | Özellikler | Koli Adedi | Fiyat |
|-----------|--------------|------------|----------|
| 5615 7851 | 6W LED 3000K | 6 | 41,50 \$ |

Verso

Alüminyum
Enjeksiyon

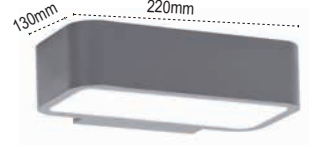

IP 54

| Kod No | Özellikler | Koli Adedi | Fiyat |
|-----------|--------------|------------|----------|
| 5616 3350 | Verso E27 | 8 | 47,80 \$ |
| 5616 3320 | 6W LED 3000K | 12 | 56,80 \$ |

Cubo

Alüminyum
Enjeksiyon

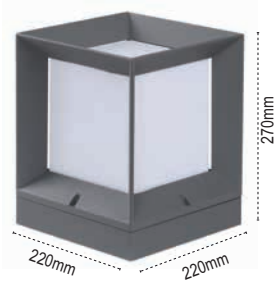

IP 54

| Kod No | Özellikler | Koli Adedi | Fiyat |
|-----------|------------|------------|----------|
| 5712 1410 | Cubo E27 | 6 | 71,50 \$ |

Rayo

Alüminyum
Enjeksiyon



IP 54

| Kod No | Özellikler | Koli Adedi | Fiyat |
|-----------|------------|------------|----------|
| 5712 1440 | Rayo E27 | 8 | 71,50 \$ |

Işıközü Sensörlü Aplik

Paslanmaz
Çelik

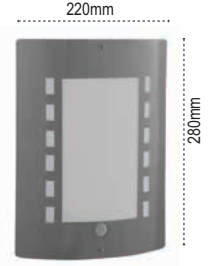

IP 44

| Kod No | Özellikler | Koli Adedi | Fiyat |
|-----------|----------------------|------------|----------|
| 5730 3420 | Işıközü Sensörlü E27 | 12 | 37,80 \$ |

Dora LED

Alüminyum
Enjeksiyon



IP 44

| Kod No | Özellikler | Koli Adedi | Fiyat |
|-----------|------------|------------|----------|
| 5732 5110 | 3W 4000K | 24 | 39,00 \$ |

Briled

Alüminyum
Enjeksiyon

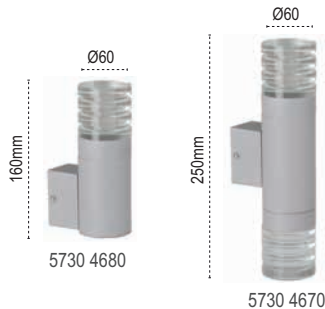

IP 54

| Kod No | Özellikler | Koli Adedi | Fiyat |
|-----------|------------------|------------|----------|
| 5730 4670 | 2x5W Aplik 4000K | 6 | 38,00 \$ |
| 5730 4680 | 5W Aplik 4000K | 6 | 30,00 \$ |

Işılray

Alüminyum
Enjeksiyon

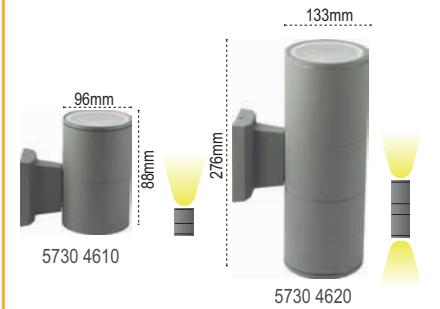

IP 44

| Kod No | Özellikler | Koli Adedi | Fiyat |
|-----------|--------------|------------|----------|
| 5730 4610 | Işılray1 E27 | 18 | 30,50 \$ |
| 5730 4620 | Işılray2 E27 | 12 | 38,00 \$ |

Pelsan Duvar Gömme & Havuz Armatürleri

Escaled S
Duvar Gömme Armatürü

Alüminyum Enjeksiyon



65x65mm

70mm
70mm
60mm

IP 54

| Kod No | Özellikler | Koli Adedi | Fiyat |
|-----------|-------------------------|------------|---------|
| 5730 9060 | Escaled S 9 LEDli 4000K | 50 | 9,50 \$ |

Escaled
Duvar Gömme Armatürü

Alüminyum Enjeksiyon

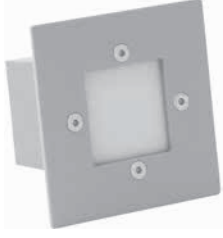

95x95mm

105mm
105mm
60mm

IP 54

| Kod No | Özellikler | Koli Adedi | Fiyat |
|-----------|------------------------|------------|----------|
| 5730 9080 | Escaled 12 LEDli 4000K | 50 | 12,60 \$ |

Leraled S

Alüminyum Enjeksiyon



98x33mm

110mm
45mm
90mm

IP 54

| Kod No | Özellikler | Koli Adedi | Fiyat |
|-----------|--------------------------|------------|---------|
| 5730 9040 | Leraled S 14 LEDli 4000K | 24 | 9,50 \$ |

Dialed
Duvar Gömme Armatürü

Alüminyum Enjeksiyon

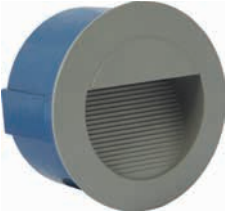

Ø115mm

Ø125mm
65mm

IP 54

| Kod No | Özellikler | Koli Adedi | Fiyat |
|-----------|--------------|------------|----------|
| 5730 9030 | Dialed 4000K | 24 | 15,80 \$ |

Pialed
Duvar Gömme Armatürü

Alüminyum Enjeksiyon

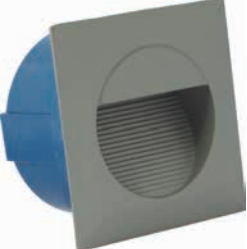

Ø115mm

125mm
65mm
125mm

IP 54

| Kod No | Özellikler | Koli Adedi | Fiyat |
|-----------|--------------|------------|----------|
| 5730 9010 | Pialed 4000K | 24 | 15,80 \$ |

İndiled
Duvar Gömme Armatürü

Alüminyum Enjeksiyon



134x81mm

162mm
98mm
66mm

IP 44

| Kod No | Özellikler | Koli Adedi | Fiyat |
|-----------|---------------|------------|----------|
| 5732 1690 | İndiled 4000K | 20 | 12,70 \$ |

Erbaled

Yeni Ürün

Alüminyum Enjeksiyon



4000K
6500K
Amber
Yeşil

70mm
Ø155mm
270mm
90mm

IP 65

| Kod No | Özellikler | Koli Adedi | Fiyat |
|-----------|----------------------|------------|----------|
| 5615 4021 | Erbaled 20W | 10 | 78,00 \$ |
| 5732 7030 | Saplama Aparatı 21cm | 1 | 7,00 \$ |

Grassled
Çimen Armatürü

Alüminyum Enjeksiyon



115mm
311mm

IP 65

| Kod No | Özellikler | Koli Adedi | Fiyat |
|-----------|-------------------|------------|----------|
| 5732 7010 | GrassLED 3W 6500K | 20 | 17,00 \$ |
| 5732 7090 | GrassLED 3W Yeşil | 20 | 17,00 \$ |
| 5730 7020 | Saplama Aparatı | 1 | 5,00 \$ |

LEDli Gömme Havuz Armatürü
24V AC

Alüminyum Enjeksiyon



Ø360mm
150mm
240mm

IP 68

| Kod No | Özellikler | Koli Adedi | Fiyat |
|-----------|-------------------------|------------|-----------|
| 5412 1270 | Havuz Armatürü12x1W RGB | 1 | 102,00 \$ |

LEDli Yer Gömme 20 15 LED'li

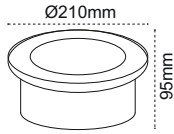

IP65

| Kod No | Özellikler | Koli Adedi | Fiyat |
|-----------|------------------------------|------------|-----------|
| 5732 3120 | 15W LEDli Yer Gömme 20 4000K | 8 | 115,00 \$ |

LEDli Yer Gömme 15 9 LED'li

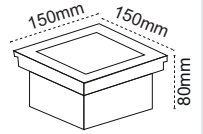

IP65

| Kod No | Özellikler | Koli Adedi | Fiyat |
|-----------|-----------------------------|------------|----------|
| 5732 3020 | 9W LEDli Yer Gömme 15 4000K | 12 | 76,00 \$ |

Midiled 3 LEDli

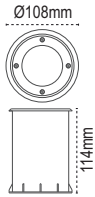

IP65

| Kod No | Özellikler | Koli Adedi | Fiyat |
|-----------|------------------|------------|----------|
| 5732 1670 | 3W Midiled 4000K | 20 | 89,00 \$ |

Miniled

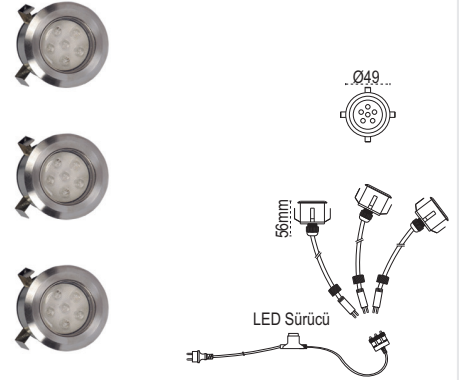

Sürücü ile Birlikte Üçlü Satılmaktadır.

IP65

| Kod No | Özellikler | Koli Adedi | Fiyat |
|-----------|------------------------|------------|----------|
| 5732 1020 | Miniled Yer Gömme Mavi | 12 | 25,00 \$ |

Yer Gömme 11 GU10 Duylu (Lamba Hariç)

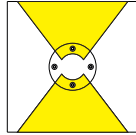

Duoled

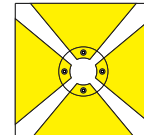

Tetraled

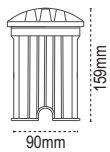

IP 67

| Kod No | Özellikler | Koli Adedi | Fiyat |
|-----------|---------------------------------|------------|----------|
| 5732 2520 | Duoled Yer Gömme - Çift Yönlü | 30 | 25,60 \$ |
| 5732 2530 | Tetraled Yer Gömme - Dört Yönlü | 30 | 25,60 \$ |

2 Kere Kazan Hem Alırken Hem Kullanırken



• Diğer Lambalara Göre 15 Kat Daha Çevreci



• %90 'a Varan Enerji Tasarrufu



LED Glop Lambalar

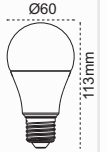

| Kod No | Özellikler | Koli Adedi | Fiyat |
|-----------|--------------|------------|---------|
| 5981 2660 | 5W 2700K E27 | 100 | 2,30 \$ |
| 5981 2650 | 5W 6400K E27 | 100 | 2,30 \$ |
| 5981 2680 | 7W 2700K E27 | 100 | 2,50 \$ |
| 5981 2690 | 7W 6400K E27 | 100 | 2,50 \$ |

| Kod No | Özellikler | Koli Adedi | Fiyat |
|-----------|---------------|------------|---------|
| 5981 2790 | 10W 6400K E27 | 100 | 2,65 \$ |

Dim Edilebilir LED Lamba

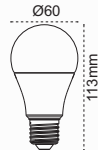

| Kod No | Özellikler | Koli Adedi | Fiyat |
|-----------|---------------|------------|---------|
| 5981 4010 | 10W 6500K E27 | 50 | 8,70 \$ |

Şarj Edilebilir LED Lamba

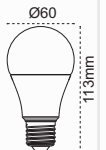

| Kod No | Özellikler | Koli Adedi | Fiyat |
|-----------|---------------|------------|---------|
| 5981 4050 | 10W 6500K E27 | 50 | 9,00 \$ |

Buji LED Lamba (E14-E27)

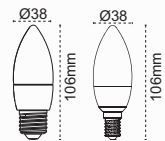

| Kod No | Özellikler | Koli Adedi | Fiyat |
|-----------|--------------|------------|---------|
| 5981 2530 | 4W 2700K E14 | 100 | 2,30 \$ |
| 5981 2540 | 4W 6500K E27 | 100 | 2,30 \$ |

Kapsül Lamba (G4-G9)

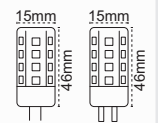

| Kod No | Özellikler | Koli Adedi | Fiyat |
|-----------|-------------------------|------------|---------|
| 5983 1410 | 3W Kapsül 3000K G4 12V | 100 | 3,00 \$ |
| 5983 1420 | 3W Kapsül 3000K G9 220V | 100 | 3,00 \$ |
| 5983 1430 | 3W Kapsül 3000K G4 220V | 100 | 3,00 \$ |



Buji Filament Lamba

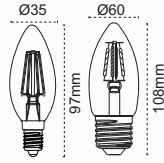

| Kod No | Özellikler | Koli Adedi | Fiyat |
|-----------|-------------------------|------------|---------|
| 5982 2040 | 4W Buji Lamba E27 3000K | 100 | 4,60 \$ |
| 5982 2060 | 4W Buji Lamba E27 6500K | 100 | 4,60 \$ |
| 5982 2130 | 4W Buji Lamba E14 3000K | 100 | 4,60 \$ |
| 5982 2140 | 4W Buji Lamba E14 6500K | 100 | 4,60 \$ |

Kıvrık Buji Filament Lamba

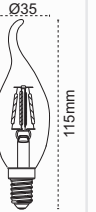

| Kod No | Özellikler | Koli Adedi | Fiyat |
|-----------|--------------------------------|------------|---------|
| 5982 2030 | 4W Buji Kıvrık Lamba E14 3000K | 100 | 4,60 \$ |
| 5982 2020 | 4W Buji Kıvrık Lamba E14 6500K | 100 | 4,60 \$ |

Filament Lamba (Ø60)

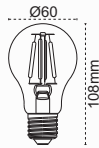

| Kod No | Özellikler | Koli Adedi | Fiyat |
|-----------|-----------------------------|------------|---------|
| 5982 2050 | 4W Filament Lamba E27 3000K | 100 | 4,80 \$ |
| 5982 2120 | 4W Filament Lamba E27 6500K | 100 | 4,80 \$ |

Filament Lamba (Ø95)

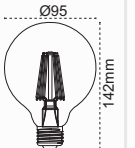

| Kod No | Özellikler | Koli Adedi | Fiyat |
|-----------|-----------------------|------------|---------|
| 5982 2080 | 6W Filament E27 3000K | 20 | 8,90 \$ |

Filament Lamba (Ø125)



| Kod No | Özellikler | Koli Adedi | Fiyat |
|-----------|-----------------------|------------|----------|
| 5982 2090 | 6W Filament E27 3000K | 20 | 10,00 \$ |

Filament Lamba (Ø64)

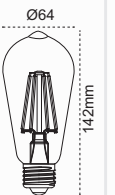

| Kod No | Özellikler | Koli Adedi | Fiyat |
|-----------|-----------------------|------------|---------|
| 5982 2070 | 6W Filament E27 3000K | 40 | 6,50 \$ |

LED Tüp Lambalar

24w

18w

9w

Değiştirmeden Dönüştürün

LED Tüp Lambalar

130 lm/W **Yeni Ürün**



axbxcmm
9W : 602x597x29
18W : 1214x1209x30
24W : 1510x1505x30

| Kod No | Özellikler | Koli Adedi | Fiyat | Kod No | Özellikler | Koli Adedi | Fiyat |
|-----------|-----------------------|------------|---------|-----------|-----------------------------|------------|----------|
| 5985 5180 | 9W 4000K LED Tüp G13 | 25 | 4,90 \$ | 5985 5290 | 24W 6500K Pro LED Tüp G13 | 25 | 21,50 \$ |
| 5985 5190 | 9W 6500K LED Tüp G13 | 25 | 4,90 \$ | 5985 5260 | 24W 4000K LED Tüp G13 | 25 | 9,40 \$ |
| 5985 5220 | 18W 4000K LED Tüp G13 | 25 | 6,10 \$ | 5985 5250 | 24W 6500K LED Tüp G13 | 25 | 9,40 \$ |
| 5985 5210 | 18W 6500K LED Tüp G13 | 25 | 6,10 \$ | 5913 1460 | 9-18W LED Tüp Konvertör Kit | 100 | 52,60 \$ |

30-40-50w LED Lamba

Yeni Ürün



30W

5981 2860



40W

5981 2870



50W

5981 2880



Øxh mm
30W : 1214x1209x30
40W : 1510x1505x30
50W : 1510x1505x30

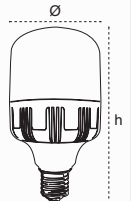

| Kod No | Özellikler | Koli Adedi | Fiyat | Kod No | Özellikler | Koli Adedi | Fiyat |
|-----------|---------------|------------|----------|-----------|---------------|------------|----------|
| 5981 2860 | 30W 6500K E27 | 20 | 14,90 \$ | 5981 2870 | 40W 6500K E27 | 20 | 18,70 \$ |
| | | | | 5981 2880 | 50W 6500K E27 | 20 | 23,40 \$ |

24w LED Lamba



Alüminyum DİP



| Kod No | Özellikler | Koli Adedi | Fiyat |
|-----------|---------------|------------|----------|
| 5981 2840 | 24W 6500K E27 | 25 | 46,90 \$ |

Dairesel LED Lamba

Alüminyum DİP

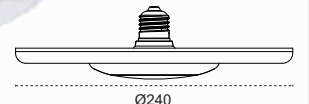

| Kod No | Özellikler | Koli Adedi | Fiyat |
|-----------|----------------------------|------------|----------|
| 5981 3010 | 18W Dairesel Ø24 E27 6500K | 20 | 11,00 \$ |

Sodyum Lambalar

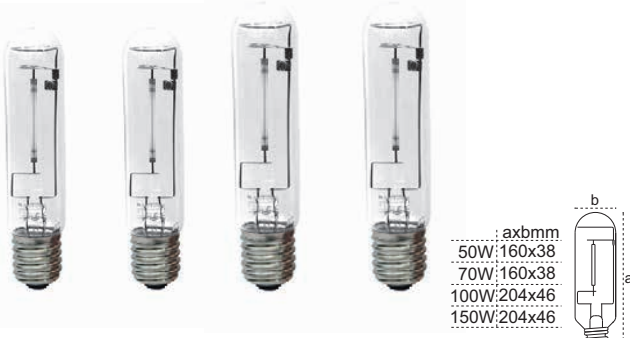

| Kod No | Özellikler | Koli Adedi | Fiyat |
|-----------|----------------|------------|---------|
| 5984 5010 | 50 2000K E27 | 25 | 6,50 \$ |
| 5984 5020 | 70W 2000K E27 | 25 | 6,50 \$ |
| 5984 5030 | 100W 2000K E40 | 24 | 7,50 \$ |
| 5984 5040 | 150W 2000K E40 | 24 | 8,00 \$ |

Sodyum Lambalar



| Kod No | Özellikler | Koli Adedi | Fiyat |
|-----------|-----------------|------------|----------|
| 5984 5050 | 250W 2000K E40 | 24 | 10,20 \$ |
| 5984 5060 | 400W 2000K E40 | 24 | 11,30 \$ |
| 5984 5070 | 1000W 2000K E40 | 20 | 56,70 \$ |

Metal Lambalar



| Kod No | Özellikler | Koli Adedi | Fiyat |
|-----------|----------------|------------|----------|
| 5984 6560 | 150W 5500K E40 | 24 | 11,30 \$ |
| 5984 6070 | 250W 5500K E40 | 24 | 11,30 \$ |

Metal Lambalar



| Kod No | Özellikler | Koli Adedi | Fiyat |
|-----------|-----------------|------------|----------|
| 5984 6080 | 400W 5500K E40 | 24 | 11,30 \$ |
| 5984 6020 | 1000W 5500K E40 | 20 | 56,70 \$ |

Metal Lambalar

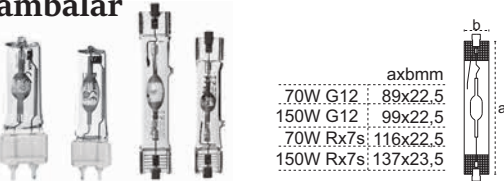

| Kod No | Özellikler | Koli Adedi | Fiyat |
|-----------|-----------------|------------|----------|
| 5984 6510 | 70W 5500K G12 | 100 | 10,50 \$ |
| 5984 6520 | 150W 5500K G12 | 100 | 11,50 \$ |
| 5984 6540 | 70W 3000K G12 | 100 | 10,50 \$ |
| 5984 6550 | 150W 3000K G12 | 100 | 11,50 \$ |
| 5984 6010 | 70W 5500K Rx7s | 100 | 9,00 \$ |
| 5981 6110 | 150W 5500K Rx7s | 100 | 9,00 \$ |

Par Lamba



| Kod No | Özellikler | Koli Adedi | Fiyat |
|-----------|-----------------------------|------------|----------|
| 5981 2710 | 12X1W PAR38 Lamba 4000K E27 | 20 | 10,40 \$ |
| 5981 2720 | 12X1W PAR38 Lamba 6500K E27 | 20 | 10,40 \$ |

Power LED Lamba & COB LED Lamba



| Kod No | Özellikler | Koli Adedi | Fiyat |
|-----------|-------------------|------------|---------|
| 5981 1120 | 3X1W 6500K GU10 | 100 | 3,45 \$ |
| 5981 2920 | 5W COB 3000K GU10 | 200 | 4,20 \$ |

Power LED Lamba



| Kod No | Özellikler | Koli Adedi | Fiyat |
|-----------|------------------|------------|---------|
| 5981 1170 | 3X1W 4000K GU10 | 200 | 1,60 \$ |
| 5981 1320 | 3X1W 3000K GU5,3 | 200 | 1,60 \$ |
| 5981 1310 | 3X1W 6500K GU5,3 | 200 | 1,60 \$ |

Ömrü Boyunca Aynı Işık Çıktısı

- 30.000 saat ömür
- Etkin ısı tekniği sağlayan özel LED kilidi
- 3M Bant
- Her 3 modülde bir kesilebilme
- 12V DC ile çalışır

| Sürücü | LED Şerit |
|--------|-----------|
| 2,5 A | max 2,5m |
| 5 A | max 5m |
| 8 A | max 8m |
| 12,5 A | max 12m |
| 17 A | max 15m |
| 30 A | max 30m |

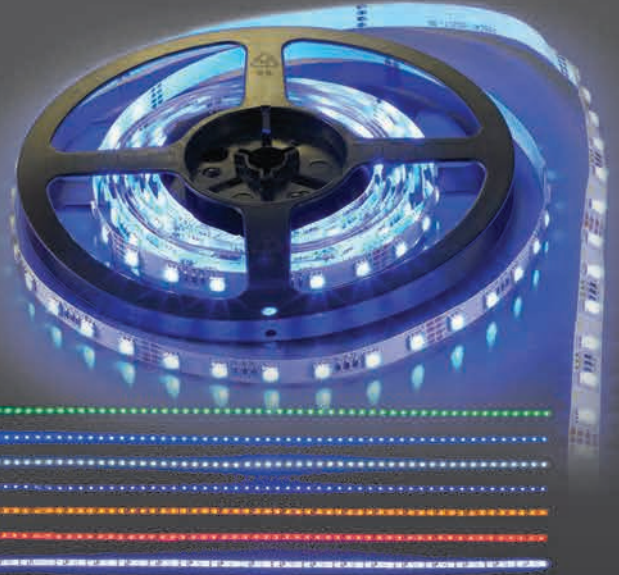

İç Mekan LED Şerit Üç Çip IP20



• 2,26 \$/m

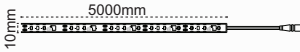

12V DC IP 20

| Kod No | Özellikler | Koli Adedi | Fiyat |
|-----------|---------------------------------|------------|----------|
| 5985 3210 | IP20 SMD LED Beyaz 5 metre | 1 | 11,30 \$ |
| 5985 3220 | IP20 SMD LED Sarı 5 metre | 1 | 11,30 \$ |
| 5985 3230 | IP20 SMD LED Kırmızı 5 metre | 1 | 11,30 \$ |
| 5985 3240 | IP20 SMD LED Yeşil 5 metre | 1 | 11,30 \$ |
| 5985 3250 | IP20 SMD LED Mavi 5 metre | 1 | 11,30 \$ |
| 5985 3260 | IP20 SMD LED Ilık Beyaz 5 metre | 1 | 11,30 \$ |
| 5985 3270 | IP20 SMD LED RGB 5 metre | 1 | 15,10 \$ |

Dış Mekan LED Şerit Üç Çip IP55

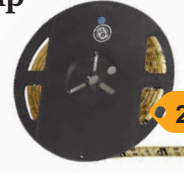

• 2,82 \$/m

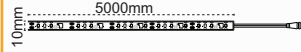

12V DC IP 65

| Kod No | Özellikler | Koli Adedi | Fiyat |
|-----------|---------------------------------|------------|----------|
| 5985 2510 | IP55 SMD LED Beyaz 5 metre | 1 | 14,10 \$ |
| 5985 2520 | IP55 SMD LED Sarı 5 metre | 1 | 14,10 \$ |
| 5985 2530 | IP55 SMD LED Kırmızı 5 metre | 1 | 14,10 \$ |
| 5985 2540 | IP55 SMD LED Yeşil 5 metre | 1 | 14,10 \$ |
| 5985 2550 | IP55 SMD LED Mavi 5 metre | 1 | 14,10 \$ |
| 5985 2560 | IP55 SMD LED Ilık Beyaz 5 metre | 1 | 14,10 \$ |
| 5985 2580 | IP55 SMD LED Amber 5 metre | 1 | 14,10 \$ |
| 5985 2570 | IP55 SMD LED RGB 5 metre | 1 | 18,85 \$ |

12V IP20 Sabit Gerilim Sürücüler

ultra slim



| Kod No | Özellikler | Koli Adedi | Fiyat |
|-----------|----------------|------------|----------|
| 5918 2411 | 36W 12V 3A | 100 | 5,75 \$ |
| 5918 2421 | 60W 12V 5A | 120 | 8,50 \$ |
| 5981 2431 | 100W 12V 8,5A | 80 | 9,45 \$ |
| 5981 2441 | 150W 12V 12,5A | 60 | 14,15 \$ |
| 5918 2451 | 200W 12V 16,5A | 36 | 15,10 \$ |
| 5918 2461 | 360W 12V 30A | 36 | 20,75 \$ |

12V IP67 Sabit Gerilim Sürücüler



| Kod No | Özellikler | Koli Adedi | Fiyat |
|-----------|---------------|------------|----------|
| 5918 2470 | 60W 12V 5A | 70 | 18,85 \$ |
| 5918 2480 | 100W 12V 8,5A | 72 | 33,95 \$ |



Neon LED ve Zincir Modül



Neon LED

- 7 farklı renk seçeneği
- Esnekliği sayesinde uygulama kolaylığı
- Metrede bir kesilebilme
- 50 metreye kadar kesintisiz kullanım
- 220V AC ile çalışma
- IP65 koruma sınıfı



Neon LED



Yeni
Ürün

IP 65

| Kod No | Özellikler | Koli Adedi | Fiyat |
|-----------|---|------------|-----------|
| 5985 4010 | Neon LED Sarı | 1 | 307,50 \$ |
| 5985 4020 | Neon LED Kırmızı | 1 | 307,50 \$ |
| 5985 4030 | Neon LED Mavi | 1 | 307,50 \$ |
| 5985 4040 | Neon LED Yeşil | 1 | 307,50 \$ |
| 5985 4050 | Neon LED Beyaz | 1 | 307,50 \$ |
| 5985 4060 | Neon LED Ilık Beyaz | 1 | 307,50 \$ |
| 5985 4070 | Neon LED RGB | 1 | 525,50 \$ |
| 5985 4110 | Neon LED Bağlantı Aparatı (Fişli Kablolu) | 1 | 7,60 \$ |
| 5985 4120 | Neon LED RGB Bağlantı Aparatı (RGB Fişli Kablo) | 1 | 8,60 \$ |
| 5985 4130 | Neon LED Alüminyum Montaj Aparatı (5 cm) | 1 | 0,80 \$ |
| 5985 4090 | Neon LED Birleştirme Aparatı | 1 | 0,20 \$ |
| 5985 4080 | Neon LED Sonlandırma Aparatı | 1 | 0,20 \$ |

3'lü Zincir Modül

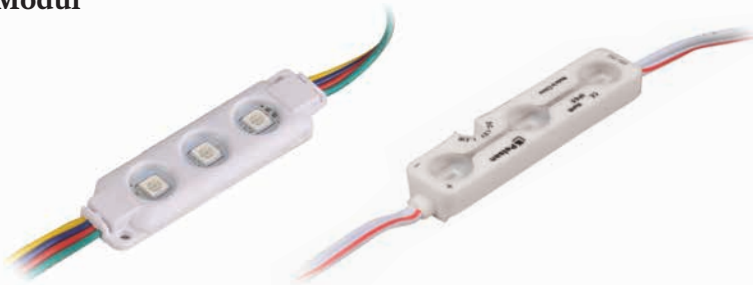

- 3M bant ile kolay montaj
- 6 farklı renk seçeneği
- 12V DC ile çalışma
- IP 65 koruma sınıfı

Yeni
Ürün

IP 65

| Kod No | Özellikler | Koli Adedi | Fiyat |
|-----------|----------------------------|------------|-----------|
| 5985 1030 | 1,2W 12V Beyaz 100'lü | 2000 | 67,00 \$ |
| 5985 1040 | 1,2W 12V Ilık Beyaz 100'lü | 2000 | 67,00 \$ |
| 5985 1050 | 1,2W 12V Kırmızı 100'lü | 2000 | 75,00 \$ |
| 5985 1060 | 1,2W 12V Sarı 100'lü | 2000 | 75,00 \$ |
| 5985 1070 | 1,2W 12V Amber 100'lü | 2000 | 75,00 \$ |
| 5985 1080 | 0,72W 12V RGB 100'lü | 2000 | 100,00 \$ |



LED Bar ve Sürücüler

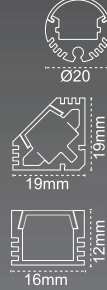

Her Mekana Özel Çözüm!

- Sıva altı, sıva üstü ve köşe seçeneği
- IP67 dış mekan, IP20 iç mekan uygulaması
- 30 / 50 / 100 / 200 cm boy opsiyonu
- 2700 / 3000 / 4000 / 6500K Kırmızı / Yeşil / Mavi / Amber
- 60 / 120 adet LED opsiyonu

İç Mekan LED Bar IP20



IP 20

| Kod No | Ozellikler | Koli Adedi | Fiyat |
|-----------|-----------------------------------|------------|----------|
| 5618 1114 | LED Bar S.Ü. 19W 60 LED/m 100 cm | 1 | 27,30 \$ |
| 5618 3114 | LED Bar Köşe 19W 60 LED/m 100 cm | 1 | 27,30 \$ |
| 5618 2114 | LED Bar S.A. 19W 60 LED/m 100 cm | 1 | 27,30 \$ |
| 5618 1314 | LED Bar S.Ü. 29W 120 LED/m 100 cm | 1 | 33,90 \$ |
| 5618 3314 | LED Bar Köşe 29W 120 LED/m 100 cm | 1 | 33,90 \$ |
| 5618 2314 | LED Bar S.A. 29W 120 LED/m 100 cm | 1 | 33,90 \$ |

Dış Mekan LED Bar IP67



IP 67

| Kod No | Ozellikler | Koli Adedi | Fiyat |
|-----------|-----------------------------------|------------|----------|
| 5618 1124 | LED Bar S.Ü. 19W 60 LED/m 100 cm | 1 | 35,00 \$ |
| 5618 3124 | LED Bar Köşe 19W 60 LED/m 100 cm | 1 | 35,00 \$ |
| 5618 2124 | LED Bar S.A. 19W 60 LED/m 100 cm | 1 | 35,00 \$ |
| 5618 1324 | LED Bar S.Ü. 29W 120 LED/m 100 cm | 1 | 42,60 \$ |
| 5618 3324 | LED Bar Köşe 29W 120 LED/m 100 cm | 1 | 42,60 \$ |
| 5618 2324 | LED Bar S.A. 29W 120 LED/m 100 cm | 1 | 42,60 \$ |

İç Mekan LED Bar Sürücüler



ultra slim

IP 20

| Kod No | Ozellikler | 60 LED/m | 120 LED/m | Koli Adedi | Fiyat |
|-----------|---------------|----------|-----------|------------|----------|
| 5918 2611 | 60W 24V 2,5A | max 3m | max 2m | 120 | 11,40 \$ |
| 5918 2620 | 120W 24V 5A | max 6m | max 4m | 80 | 26,50 \$ |
| 5918 2630 | 200W 24V 8,5A | max 9m | max 6m | 36 | 27,40 \$ |
| 5918 2640 | 360W 24V 15A | max 16m | max 12m | 36 | 28,40 \$ |

Dış Mekan LED Bar Sürücüler



IP 67

| Kod No | Ozellikler | 60 LED/m | 120 LED/m | Koli Adedi | Fiyat |
|-----------|---------------|----------|-----------|------------|----------|
| 5918 2650 | 150W 24V 6A | max 6m | max 4m | 1 | 47,30 \$ |
| 5918 2660 | 200W 24V 8,5A | max 9m | max 6m | 1 | 56,80 \$ |

Difüzör Çeşitleri

| Kod No | Ozellikler | Koli Adedi | Fiyat |
|----------|--|------------|---------|
| 4301 662 | Buzlu Bombeli (Sıva Üstü LED Bar) 100 cm Difüzör | 1 | 2,50 \$ |
| 4301 652 | Şeffaf Bombeli (Sıva Üstü LED Bar) 100 cm Difüzör | 1 | 2,50 \$ |
| 4301 642 | Opal Bombeli (Sıva Üstü LED Bar) 100 cm Difüzör | 1 | 2,50 \$ |
| 4301 692 | Buzlu Düz (Sıva Altı / Köşe LED Bar) 100 cm Difüzör | 1 | 2,50 \$ |
| 4301 682 | Şeffaf Düz (Sıva Altı / Köşe LED Bar) 100 cm Difüzör | 1 | 2,50 \$ |
| 4301 672 | Opal Düz (Sıva Altı / Köşe LED Bar) 100 cm Difüzör | 1 | 2,50 \$ |

Y.B Metal Halide

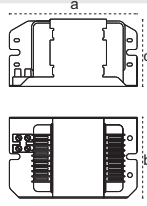

IP 40 ☺

| Kod No | Özellikler | axbxcmm | Koli Adedi | Fiyat |
|-----------|---------------------------|-------------|------------|----------|
| 5912 1181 | Metal Halide 35W | 155x42x33 | 24 | 8,15 \$ |
| 5912 1211 | Metal Halide 70W | 116x64x54 | 16 | 9,05 \$ |
| 5912 1221 | Metal Halide 150W | 122x78x66 | 8 | 13,30 \$ |
| 5912 1231 | Metal Halide 250W | 135x93x79 | 4 | 20,70 \$ |
| 5912 1241 | Metal Halide 400W | 135x93x79 | 4 | 22,90 \$ |
| 5912 1251 | Metal Halide 1000W | 197x126x138 | 2 | 59,10 \$ |
| 5912 1261 | Metal Halide 2000W (380V) | 225x126x138 | 1 | 92,30 \$ |

Y.B Sodyum Buharlı

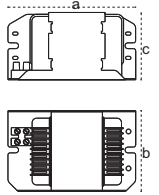

IP 40 ☺

| Kod No | Özellikler | axbxcmm | Koli Adedi | Fiyat |
|-----------|----------------------|-------------|------------|----------|
| 5912 1071 | Sodyum Buharlı 50W | 116x64x54 | 16 | 8,15 \$ |
| 5912 1101 | Sodyum Buharlı 70W | 116x64x54 | 16 | 9,05 \$ |
| 5912 1081 | Sodyum Buharlı 100W | 116x64x54 | 16 | 9,65 \$ |
| 5912 1111 | Sodyum Buharlı 150W | 122x78x66 | 4 | 13,30 \$ |
| 5912 1121 | Sodyum Buharlı 250W | 135x93x72 | 4 | 20,70 \$ |
| 5912 1131 | Sodyum Buharlı 400W | 156x93x69 | 2 | 26,70 \$ |
| 5912 1161 | Sodyum Buharlı 600W | 178x126x138 | 2 | 46,20 \$ |
| 5912 1141 | Sodyum Buharlı 1000W | 197x126x138 | 2 | 59,10 \$ |

Metal Kitler

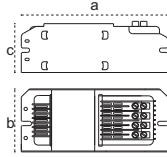

IP 20 ☺

| Kod No | Özellikler | axbxcmm | Koli Adedi | Fiyat |
|-----------|---------------------------------|-------------|------------|----------|
| 5511 2481 | Metal Kit 35W Balast + ignitör | 185x115x88 | 4 | 17,50 \$ |
| 5511 2431 | Metal Kit 70W Balast + ignitör | 150x64x54 | 4 | 18,50 \$ |
| 5511 2441 | Metal Kit 150W Balast + ignitör | 166x77x65 | 4 | 26,90 \$ |
| 5511 2451 | Metal Kit 250W Balast + ignitör | 205x93x79 | 4 | 34,60 \$ |
| 5511 2461 | Metal Kit 400W Balast + ignitör | 232x93x79 | 4 | 36,90 \$ |
| 5611 2981 | Olimpiad Kiti 1000W | 246x126x138 | 1 | 93,50 \$ |

Sera Kitler

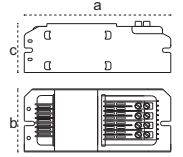

IP 20 ☺

| Kod No | Özellikler | axbxcmm | Koli Adedi | Fiyat |
|-----------|--------------------------|-------------|------------|----------|
| 5511 2391 | Sera 400W SB Balast Kiti | 232x93x79 | 4 | 43,50 \$ |
| 5511 2401 | Sera 600W SB Balast Kiti | 246x126x138 | 1 | 71,60 \$ |

Silver Floresant Balast

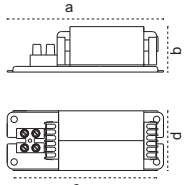

IP 40 ☺

| Kod No | Özellikler | axbxcxmm | Koli Adedi | Fiyat |
|-----------|------------|----------------|------------|---------|
| 5911 3001 | 15W TLD | 100x32,2x87x42 | 36 | 3,10 \$ |
| 5911 3061 | 20W TLD | 100x32,2x87x42 | 36 | 3,10 \$ |
| 5911 3091 | 32W TLD | 100x32,2x87x42 | 36 | 3,10 \$ |
| 5911 3071 | 36-40W TLD | 100x32,2x87x42 | 36 | 3,10 \$ |

Elektronik Balast

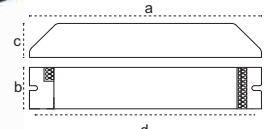

IP 40 ☺

| Kod No | Özellikler | axbxcxmm | Koli Adedi | Fiyat |
|-----------|------------|---------------|------------|----------|
| 5917 1010 | 1X18W TLD | 295x31x29x285 | 10 | 11,60 \$ |
| 5917 1030 | 2X18W TLD | 295x31x29x285 | 10 | 12,60 \$ |
| 5917 1020 | 1X36W TLD | 295x31x29x285 | 10 | 11,60 \$ |
| 5917 1040 | 2X36W TLD | 295x31x29x285 | 10 | 12,60 \$ |
| 5917 1620 | 4X14W T5 | 332x34x32x322 | 10 | 15,00 \$ |

Konvertör Kitler

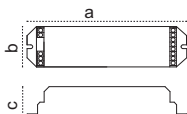

IP 20 ☺

| Kod No | Özellikler | axbxcmm | Koli Adedi | Fiyat |
|-----------|--------------------------------------|-----------|------------|----------|
| 5913 1090 | 18-36W Mekanik Balast için 1 Saat | 170x43x31 | 10 | 37,80 \$ |
| 5913 1120 | 18-36W Mekanik Balast için 3 Saat | 170x43x31 | 10 | 37,80 \$ |
| 5913 1580 | 18-36W Elektronik Balast için 1 Saat | 170x43x31 | 10 | 42,00 \$ |
| 5913 1590 | 18-36W Elektronik Balast için 3 Saat | 170x43x31 | 10 | 42,00 \$ |

LED Konvertör Kitler



5913 1470



5913 1460

IP 20 ☺

| Kod No | Özellikler | Koli Adedi | Fiyat |
|-----------|------------------------------|------------|----------|
| 5913 1460 | 9-18W LED Tube Konvertör Kit | 100 | 52,60 \$ |
| 5913 1470 | 12-110V LED Konvertör Kit | 100 | 29,00 \$ |

Zaman Ayarlı Ateşleyici

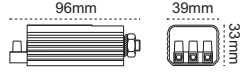

IP 20

| Kod No | Özellikler | Koli Adedi | Fiyat |
|----------|----------------------|------------|---------|
| 3140 132 | Zaman Ayarlı 50-400W | 10 | 5,80 \$ |
| 3140 101 | İgnitör 70-400W | 10 | 9,00 \$ |

Uzaktan Ateşleyici

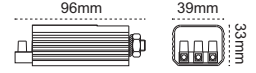

IP 20

| Kod No | Özellikler | Koli Adedi | Fiyat |
|----------|------------------------|------------|----------|
| 3140 141 | 600-1000W (25 m kadar) | 10 | 16,00 \$ |
| 3140 125 | İgnitör 600-1000W | 10 | 16,00 \$ |

Starter

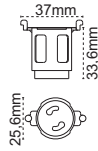

IP 20

| Kod No | Özellikler | Koli Adedi | Fiyat |
|----------|------------|------------|---------|
| 3120 106 | 4-65W | 25 | 0,19 \$ |
| 3120 107 | Seri 4-22W | 25 | 0,22 \$ |

Asma Duy



IP 20

| Kod No | Özellikler | Koli Adedi | Fiyat |
|----------|-------------------------|------------|---------|
| 3170 131 | Pelsan Asma Duy E27 | 50 | 0,80 \$ |
| 3170 133 | Porselen Tij Takımı E27 | 50 | 0,80 \$ |

Lamba Duyları

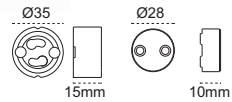

IP 40

| Kod No | Özellikler | Koli Adedi | Fiyat |
|----------|--------------------|------------|---------|
| 3110 120 | GU10 Porselen Duy | 100 | 0,55 \$ |
| 3110 201 | GX5.3 Porselen Duy | 100 | 0,25 \$ |
| 3110 122 | G12 Porselen Duy | 100 | 1,90 \$ |

Porselen Duylar

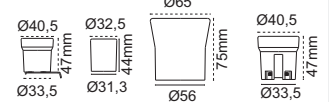

IP 40

| Kod No | Özellikler | Koli Adedi | Fiyat |
|----------|-------------------------|------------|---------|
| 3110 102 | E14 Porselen Duy | 480 | 0,30 \$ |
| 3110 112 | E14 Lamalı Porselen Duy | 400 | 0,26 \$ |
| 3110 103 | E27 Porselen Duy | 400 | 0,23 \$ |
| 3110 113 | E27 Lamalı Porselen Duy | 400 | 0,26 \$ |
| 3110 115 | E40 Porselen Duy | 100 | 2,10 \$ |

IP20 Sabit Akım LED Sürücüler

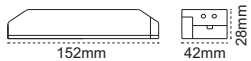

IP 20

| Kod No | Özellikler | Koli Adedi | Fiyat |
|-----------|-------------------------------------|------------|----------|
| 5918 1710 | 25W 400 mA 25-63 Vdc Çıkış Gerilimi | 100 | 21,80 \$ |
| 5918 1610 | 40W 600 mA 33-68 Vdc Çıkış Gerilimi | 100 | 29,60 \$ |

IP20 Sabit Akım LED Sürücüler

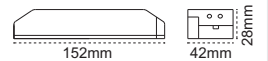

IP 20

| Kod No | Özellikler | Koli Adedi | Fiyat |
|-----------|-------------------------------------|------------|----------|
| 5918 1720 | 20W 600 mA 16-42 Vdc Çıkış Gerilimi | 100 | 22,60 \$ |
| 5918 1730 | 15W 700 mA 11-25 Vdc Çıkış Gerilimi | 100 | 13,25 \$ |

Opak Pano

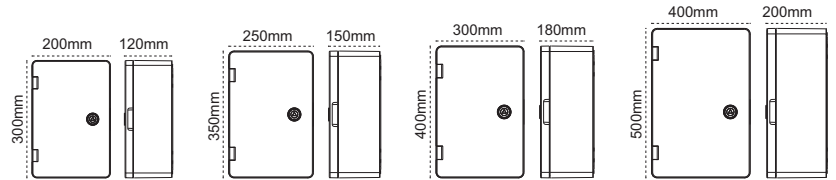

IP 40

| Kod No | Özellikler | Koli Adedi | Fiyat |
|-----------|--|------------|-----------|
| 5921 1711 | ABS Taban Saçlı 200X300X120 mm Opak Pano | 1 | 12,00 \$ |
| 5921 1721 | ABS Taban Saçlı 250X350X150 mm Opak Pano | 1 | 15,25 \$ |
| 5921 1731 | ABS Taban Saçlı 300X400X180 mm Opak Pano | 1 | 20,10 \$ |
| 5921 1741 | ABS Taban Saçlı 400X500X210mm Opak Pano | 1 | 31,0 0 \$ |

Şeffaf Pano

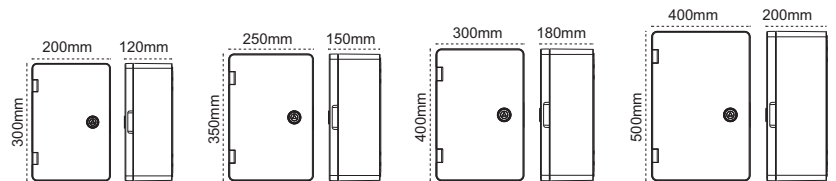

IP 40

| Kod No | Özellikler | Koli Adedi | Fiyat |
|-----------|--|------------|----------|
| 5921 1751 | ABS Taban Saçlı 200X300X120 mm Şeffaf Pano | 1 | 13,00 \$ |
| 5921 1761 | ABS Taban Saçlı 250X350X150 mm Şeffaf Pano | 1 | 16,25 \$ |
| 5921 1771 | ABS Taban Saçlı 300X400X180 mm Şeffaf Pano | 1 | 22,40 \$ |

Keira Antibakteriyel Anahtar ve Priz Serisi



Antibakteriyel K13

| Kod No | Cinsi | Koli Ad. | Keira Antibakteriyel Seri |
|-----------------------|--------------------------------------|----------|---------------------------|
| Anahtar Grubu | | | |
| 5963 1001 | Anahtar | 120 | 6,10 ₺ |
| 5963 1002 | Light | 120 | 6,40 ₺ |
| 5963 1003 | Kapı otomatığı | 120 | 6,40 ₺ |
| 5963 1004 | Zil anahtarı | 120 | 6,40 ₺ |
| 5963 1005 | Komitatör | 120 | 7,40 ₺ |
| 5963 1006 | Vavien | 120 | 7,40 ₺ |
| 5963 1007 | Permitatör | 120 | 9,20 ₺ |
| 5963 1008 | Komitatör vavien | 120 | 10,10 ₺ |
| 5963 1009 | Jaluzi anahtarı | 120 | 11,80 ₺ |
| 5963 1010 | Şofben anahtarı | 120 | 19,10 ₺ |
| 5963 1011 | 3'lü anahtar | 120 | 16,30 ₺ |
| Priz Grubu | | | |
| 5963 1014 | Priz | 120 | 6,10 ₺ |
| 5963 1015 | Topraklı priz | 120 | 7,20 ₺ |
| 5963 1016 | Çocuk korumalı topraklı priz | 120 | 9,80 ₺ |
| 5963 1017 | UPS topraklı priz | 120 | 9,20 ₺ |
| 5963 1018 | UPS çocuk korumalı topraklı priz | 120 | 9,70 ₺ |
| 5963 1019 | Kapaklı topraklı priz | 120 | 8,30 ₺ |
| 5963 1020 | Çocuk korumalı kapaklı topraklı priz | 120 | 11,20 ₺ |
| 5963 1021 | UPS kapaklı topraklı priz | 120 | 15,00 ₺ |
| 5963 1023 | İkili priz | 100 | 8,10 ₺ |
| 5963 1024 | İkili topraklı priz | 70 | 8,80 ₺ |
| TV/Radyo Grubu | | | |
| 5963 1030 | TV priz geçişli | 120 | 11,10 ₺ |
| 5963 1031 | TV priz sonlu | 120 | 11,10 ₺ |
| 5963 1032 | TV priz dirençsiz | 120 | 11,10 ₺ |
| 5963 1033 | Uydu prizi F konnektörlü geçişli | 120 | 16,50 ₺ |
| 5963 1034 | Uydu prizi F konnektörlü sonlu | 120 | 16,50 ₺ |
| 5963 1035 | TV - Radyo priz geçişli | 120 | 30,40 ₺ |
| 5963 1036 | TV - Radyo priz sonlu | 120 | 30,40 ₺ |
| 5963 1037 | TV - Sat priz geçişli | 120 | 46,70 ₺ |
| 5963 1038 | TV - Sat priz sonlu | 120 | 46,70 ₺ |

| Kod No | Cinsi | Koli Ad. | Keira Antibakteriyel Seri |
|-----------------------------|--------------------------------|----------|---------------------------|
| iletişim Grubu | | | |
| 5963 1040 | Telefon prizi | 120 | 6,10 ₺ |
| 5963 1041 | Numeris telefon prizi (RJ11) | 120 | 8,00 ₺ |
| 5963 1042 | İkili numeris (RJ11) | 120 | 12,50 ₺ |
| 5963 1043 | Data numeris (RJ45CAT5-RJ11) | 120 | 31,10 ₺ |
| 5963 1044 | Data priz (RJ45CAT5) | 120 | 30,40 ₺ |
| 5963 1045 | İkili data priz (RJ45CAT5) | 120 | 50,00 ₺ |
| 5963 1046 | Data jaksız | 120 | 7,40 ₺ |
| 5963 1047 | Data priz (RJ45CAT6) | 120 | 30,40 ₺ |
| 5963 1048 | İkili data priz (RJ45CAT6) | 120 | 50,00 ₺ |
| 5963 1049 | Data - Numeris (RJ45CAT6-RJ11) | 120 | 31,10 ₺ |
| 5963 1050 | Müzik Yayın Prizi | 80 | 61,70 ₺ |
| 5963 1052 | VGA Prizi | 80 | 96,20 ₺ |
| 5963 1059 | Müzik yayın anahtarı | 80 | 43,40 ₺ |
| Dimmer Grubu | | | |
| 5963 1055 | Dimmer 600W | 80 | 36,30 ₺ |
| 5963 1056 | Dimmer 1000W | 80 | 39,40 ₺ |
| 5963 1057 | Dimmer vavien 600W | 80 | 72,50 ₺ |
| 5963 1058 | Dimmer RC 300W | 80 | 79,00 ₺ |
| İşıkli Anahtar Grubu | | | |
| 5963 1070 | İşıkli anahtar | 120 | 8,90 ₺ |
| 5963 1071 | İşıkli light | 120 | 9,10 ₺ |
| 5963 1072 | İşıkli komitatör | 120 | 10,40 ₺ |
| 5963 1073 | İşıkli vavien | 120 | 10,40 ₺ |
| 5963 1074 | İşıkli etiketli zil | 120 | 10,20 ₺ |
| 5963 1075 | İşıkli dimmer 600W | 80 | 37,90 ₺ |
| 5963 1076 | İşıkli dimmer 1000W | 80 | 37,90 ₺ |
| 5963 1077 | İşıkli dimmer vavien 600W | 80 | 74,10 ₺ |
| 5963 1078 | İşıkli dimmer RC 300W | 80 | 80,50 ₺ |
| Çerçeveler | | | |
| 5963 1081 | 2'li çerçeve yatay-dikey | 200 | 4,40 ₺ |
| 5963 1082 | 3'lü çerçeve yatay-dikey | 150 | 5,50 ₺ |
| 5963 1083 | 4'lü çerçeve yatay-dikey | 50 | 7,10 ₺ |
| 5963 1084 | 5'li çerçeve yatay-dikey | 50 | 8,80 ₺ |
| 5963 1085 | 6'lı çerçeve yatay-dikey | 50 | 10,40 ₺ |

Keira Beyaz Anahtar ve Priz Serisi

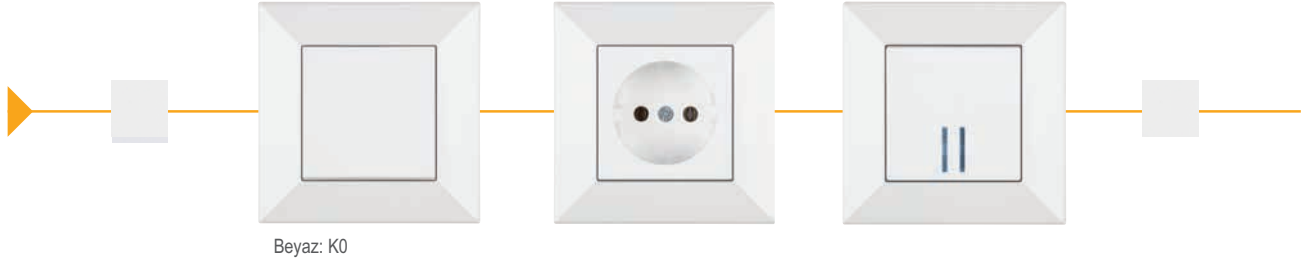

Keira Krem Anahtar ve Priz Serisi

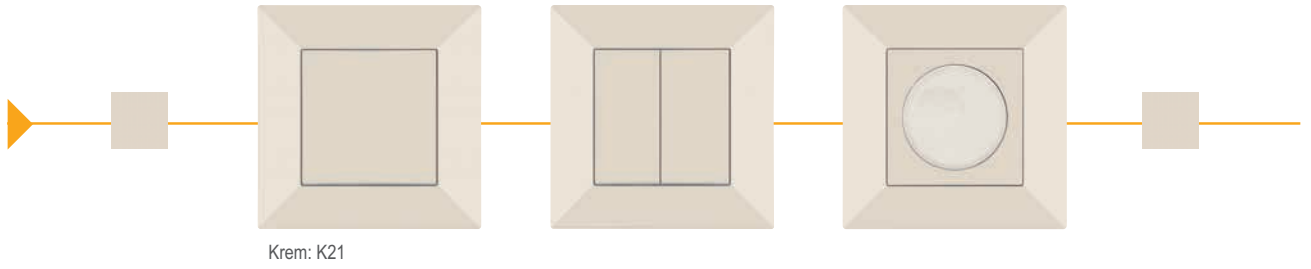

| Kod No | Cinsi | Koli Ad. | Keira Beyaz & Krem Seri |
|-----------------------|--------------------------------------|----------|----------------------------|
| Anahtar Grubu | | | |
| 5963 1001 | Anahtar | 120 | 5,70 ₺ |
| 5963 1002 | Light | 120 | 6,00 ₺ |
| 5963 1003 | Kapı otomatığı | 120 | 6,00 ₺ |
| 5963 1004 | Zil anahtarı | 120 | 6,00 ₺ |
| 5963 1005 | Komitatör | 120 | 6,90 ₺ |
| 5963 1006 | Vavien | 120 | 6,90 ₺ |
| 5963 1007 | Permitatör | 120 | 8,90 ₺ |
| 5963 1008 | Komitatör vavien | 120 | 9,70 ₺ |
| 5963 1009 | Jaluzi anahtarı | 120 | 11,40 ₺ |
| 5963 1010 | Şofben anahtarı | 120 | 18,30 ₺ |
| 5963 1011 | 3'lü anahtar | 120 | 15,50 ₺ |
| Priz Grubu | | | |
| 5963 1014 | Priz | 120 | 5,70 ₺ |
| 5963 1015 | Topraklı priz | 120 | 6,80 ₺ |
| 5963 1016 | Çocuk korumalı topraklı priz | 120 | 9,20 ₺ |
| 5963 1017 | UPS topraklı priz | 120 | 8,90 ₺ |
| 5963 1018 | UPS çocuk korumalı topraklı priz | 120 | 9,20 ₺ |
| 5963 1019 | Kapaklı topraklı priz | 120 | 7,90 ₺ |
| 5963 1020 | Çocuk korumalı kapaklı topraklı priz | 120 | 10,90 ₺ |
| 5963 1021 | UPS kapaklı topraklı priz | 120 | 14,50 ₺ |
| 5963 1023 | İkili priz | 100 | 7,80 ₺ |
| 5963 1024 | İkili topraklı priz | 70 | 8,40 ₺ |
| TV/Radyo Grubu | | | |
| 5963 1030 | TV priz geçişli | 120 | 10,70 ₺ |
| 5963 1031 | TV priz sonlu | 120 | 10,70 ₺ |
| 5963 1032 | TV priz dirençsiz | 120 | 10,70 ₺ |
| 5963 1033 | Uydu prizi F konektörlü geçişli | 120 | 16,10 ₺ |
| 5963 1034 | Uydu prizi F konektörlü sonlu | 120 | 16,10 ₺ |
| 5963 1035 | TV - Radyo priz geçişli | 120 | 29,10 ₺ |
| 5963 1036 | TV - Radyo priz sonlu | 120 | 29,10 ₺ |
| 5963 1037 | TV - Sat priz geçişli | 120 | 45,10 ₺ |
| 5963 1038 | TV - Sat priz sonlu | 120 | 45,10 ₺ |

| Kod No | Cinsi | Koli Ad. | Keira Beyaz & Krem Seri |
|-----------------------------|--------------------------------|----------|----------------------------|
| iletişim Grubu | | | |
| 5963 1040 | Telefon prizi | 120 | 5,70 ₺ |
| 5963 1041 | Numeris telefon prizi (RJ11) | 120 | 7,60 ₺ |
| 5963 1042 | İkili numeris (RJ11) | 120 | 12,10 ₺ |
| 5963 1043 | Data numeris (RJ45CAT5-RJ11) | 120 | 30,30 ₺ |
| 5963 1044 | Data priz (RJ45CAT5) | 120 | 29,10 ₺ |
| 5963 1045 | İkili data priz (RJ45CAT5) | 120 | 48,30 ₺ |
| 5963 1046 | Data jaksız | 120 | 6,90 ₺ |
| 5963 1047 | Data priz (RJ45CAT6) | 120 | 29,10 ₺ |
| 5963 1048 | İkili data priz (RJ45CAT6) | 120 | 48,30 ₺ |
| 5963 1049 | Data - Numeris (RJ45CAT6-RJ11) | 120 | 30,30 ₺ |
| 5963 1050 | Müzik Yayın Prizi | 80 | 60,00 ₺ |
| 5963 1052 | VGA Prizi | 80 | 94,60 ₺ |
| 5963 1059 | Müzik yayın anahtarı | 80 | 42,60 ₺ |
| Dimmer Grubu | | | |
| 5963 1055 | Dimmer 600W | 80 | 35,50 ₺ |
| 5963 1056 | Dimmer 1000W | 80 | 38,60 ₺ |
| 5963 1057 | Dimmer vavien 600W | 80 | 70,90 ₺ |
| 5963 1058 | Dimmer RC 300W | 80 | 77,30 ₺ |
| Işıklı Anahtar Grubu | | | |
| 5963 1070 | Işıklı anahtar | 120 | 8,40 ₺ |
| 5963 1071 | Işıklı light | 120 | 8,80 ₺ |
| 5963 1072 | Işıklı komitatör | 120 | 10,10 ₺ |
| 5963 1073 | Işıklı vavien | 120 | 10,10 ₺ |
| 5963 1074 | Işıklı etiketli zil | 120 | 9,80 ₺ |
| 5963 1075 | Işıklı dimmer 600W | 80 | 37,10 ₺ |
| 5963 1076 | Işıklı dimmer 1000W | 80 | 40,30 ₺ |
| 5963 1077 | Işıklı dimmer vavien 600W | 80 | 72,50 ₺ |
| 5963 1078 | Işıklı dimmer RC 300W | 80 | 79,00 ₺ |
| Çerçeveler | | | |
| 5963 1081 | 2'li çerçeve yatay-dikey | 200 | 4,00 ₺ |
| 5963 1082 | 3'lü çerçeve yatay-dikey | 150 | 5,00 ₺ |
| 5963 1083 | 4'lü çerçeve yatay-dikey | 50 | 6,70 ₺ |
| 5963 1084 | 5'li çerçeve yatay-dikey | 50 | 8,30 ₺ |
| 5963 1085 | 6'lı çerçeve yatay-dikey | 50 | 9,90 ₺ |

Konfigürasyon: Beyaz: K0
Krem: K21



Keira Füme Anahtar ve Priz Serisi



Keira Saten Anahtar ve Priz Serisi

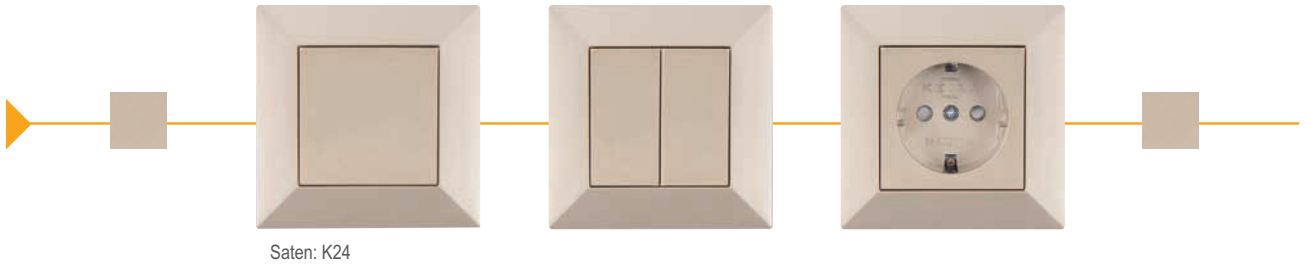

| Kod No | Cinsi | Koli Ad. | Keira Metalik Seri |
|-----------------------|--------------------------------------|----------|--------------------|
| Anahtar Grubu | | | |
| 5963 1001 | Anahtar | 120 | 10,20 ₺ |
| 5963 1002 | Light | 120 | 10,60 ₺ |
| 5963 1003 | Kapı otomatığı | 120 | 10,60 ₺ |
| 5963 1004 | Zil anahtarı | 120 | 10,60 ₺ |
| 5963 1005 | Komitatör | 120 | 11,50 ₺ |
| 5963 1006 | Vavien | 120 | 11,50 ₺ |
| 5963 1007 | Permitatör | 120 | 13,60 ₺ |
| 5963 1008 | Komitatör vavien | 120 | 14,40 ₺ |
| 5963 1009 | Jaluzi anahtarı | 120 | 16,00 ₺ |
| 5963 1010 | Şofben anahtarı | 120 | 24,00 ₺ |
| 5963 1011 | 3'lü anahtar | 120 | 21,00 ₺ |
| Priz Grubu | | | |
| 5963 1014 | Priz | 120 | 10,20 ₺ |
| 5963 1015 | Topraklı priz | 120 | 11,40 ₺ |
| 5963 1016 | Çocuk korumalı topraklı priz | 120 | 14,00 ₺ |
| 5963 1017 | UPS topraklı priz | 120 | 13,60 ₺ |
| 5963 1018 | UPS çocuk korumalı topraklı priz | 120 | 13,80 ₺ |
| 5963 1019 | Kapaklı topraklı priz | 120 | 12,60 ₺ |
| 5963 1020 | Çocuk korumalı kapaklı topraklı priz | 120 | 15,60 ₺ |
| 5963 1021 | UPS kapaklı topraklı priz | 120 | 19,30 ₺ |
| 5963 1023 | İkili priz | 100 | 12,40 ₺ |
| 5963 1024 | İkili topraklı priz | 70 | 13,00 ₺ |
| TV/Radyo Grubu | | | |
| 5963 1030 | TV priz geçişli | 120 | 15,40 ₺ |
| 5963 1031 | TV priz sonlu | 120 | 15,40 ₺ |
| 5963 1032 | TV priz dirençsiz | 120 | 15,40 ₺ |
| 5963 1033 | Uydu prizi F konnektörlü geçişi | 120 | 21,00 ₺ |
| 5963 1034 | Uydu prizi F konnektörlü sonlu | 120 | 21,00 ₺ |
| 5963 1035 | TV - Radyo priz geçişli | 120 | 34,40 ₺ |
| 5963 1036 | TV - Radyo priz sonlu | 120 | 34,40 ₺ |
| 5963 1037 | TV - Sat priz geçişli | 120 | 51,10 ₺ |
| 5963 1038 | TV - Sat priz sonlu | 120 | 51,10 ₺ |

| Kod No | Cinsi | Koli Ad. | Keira Metalik Seri |
|-----------------------------|--------------------------------|----------|--------------------|
| İletişim Grubu | | | |
| 5963 1040 | Telefon prizi | 120 | 10,20 ₺ |
| 5963 1041 | Numeris telefon prizi (RJ11) | 120 | 12,20 ₺ |
| 5963 1042 | İkili numeris (RJ11) | 120 | 16,80 ₺ |
| 5963 1043 | Data numeris (RJ45CAT5-RJ11) | 120 | 35,70 ₺ |
| 5963 1044 | Data priz (RJ45CAT5) | 120 | 34,40 ₺ |
| 5963 1045 | İkili data priz (RJ45CAT5) | 120 | 54,40 ₺ |
| 5963 1046 | Data jaksız | 120 | 11,50 ₺ |
| 5963 1047 | Data priz (RJ45CAT6) | 120 | 34,40 ₺ |
| 5963 1048 | İkili data priz (RJ45CAT6) | 120 | 54,40 ₺ |
| 5963 1049 | Data - Numeris (RJ45CAT6-RJ11) | 120 | 35,70 ₺ |
| 5963 1050 | Müzik Yayın Prizi | 80 | 67,10 ₺ |
| 5963 1052 | VGA Prizi | 80 | 104,00 ₺ |
| 5963 1059 | Müzik yayın anahtarı | 80 | 48,30 ₺ |
| Dimmer Grubu | | | |
| 5963 1055 | Dimmer 600W | 80 | 42,10 ₺ |
| 5963 1056 | Dimmer 1000W | 80 | 39,70 ₺ |
| 5963 1057 | Dimmer vavien 600W | 80 | 77,70 ₺ |
| 5963 1058 | Dimmer RC 300W | 80 | 84,50 ₺ |
| İşıkli Anahtar Grubu | | | |
| 5963 1070 | İşıkli anahtar | 120 | 13,20 ₺ |
| 5963 1071 | İşıkli light | 120 | 13,50 ₺ |
| 5963 1072 | İşıkli komitatör | 120 | 14,80 ₺ |
| 5963 1073 | İşıkli vavien | 120 | 14,80 ₺ |
| 5963 1074 | İşıkli etiketli zil | 120 | 14,40 ₺ |
| 5963 1075 | İşıkli dimmer 600W | 80 | 42,60 ₺ |
| 5963 1076 | İşıkli dimmer 1000W | 80 | 46,00 ₺ |
| 5963 1077 | İşıkli dimmer vavien 600W | 80 | 72,70 ₺ |
| 5963 1078 | İşıkli dimmer RC 300W | 80 | 86,10 ₺ |
| Çerçeveler | | | |
| 5963 1081 | 2'li çerçeve yatay-dikey | 200 | 8,40 ₺ |
| 5963 1082 | 3'lü çerçeve yatay-dikey | 150 | 9,50 ₺ |
| 5963 1083 | 4'lü çerçeve yatay-dikey | 50 | 11,20 ₺ |
| 5963 1084 | 5'li çerçeve yatay-dikey | 50 | 12,90 ₺ |
| 5963 1085 | 6'lı çerçeve yatay-dikey | 50 | 14,70 ₺ |

Keira Kiraz Anahtar ve Priz Serisi



Keira Meşe Anahtar ve Priz Serisi

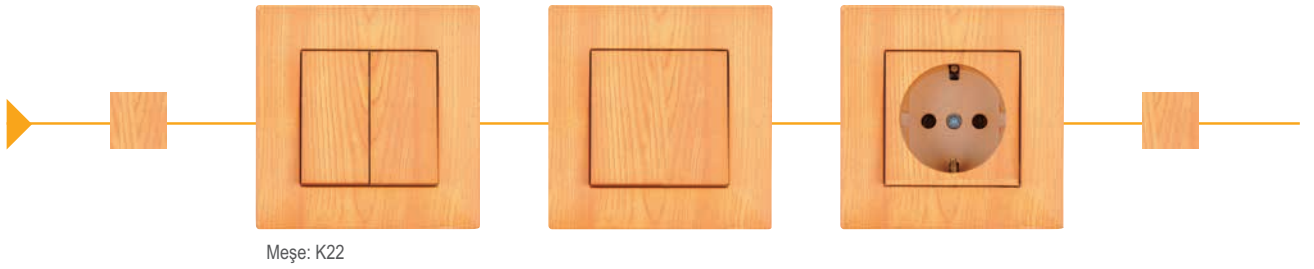

| Kod No | Cinsi | Koli Ad. | Keira Ahşap Serisi |
|-----------------------|--------------------------------------|----------|--------------------|
| Anahtar Grubu | | | |
| 5963 1001 | Anahtar | 120 | 10,70 ₺ |
| 5963 1002 | Light | 120 | 14,30 ₺ |
| 5963 1003 | Kapı otomatığı | 120 | 14,30 ₺ |
| 5963 1004 | Zil anahtarı | 120 | 14,30 ₺ |
| 5963 1005 | Komitatör | 120 | 15,60 ₺ |
| 5963 1006 | Vavien | 120 | 15,60 ₺ |
| 5963 1007 | Permitatör | 120 | 13,80 ₺ |
| 5963 1008 | Komitatör vavien | 120 | 14,80 ₺ |
| 5963 1009 | Jaluzi anahtarı | 120 | 16,30 ₺ |
| 5963 1010 | Şofben anahtarı | 120 | 24,10 ₺ |
| 5963 1011 | 3'lü anahtar | 120 | 21,20 ₺ |
| Priz Grubu | | | |
| 5963 1014 | Priz | 120 | 10,70 ₺ |
| 5963 1015 | Topraklı priz | 120 | 11,90 ₺ |
| 5963 1016 | Çocuk korumalı topraklı priz | 120 | 14,30 ₺ |
| 5963 1017 | UPS topraklı priz | 120 | 13,80 ₺ |
| 5963 1018 | UPS çocuk korumalı topraklı priz | 120 | 14,20 ₺ |
| 5963 1019 | Kapaklı topraklı priz | 120 | 12,90 ₺ |
| 5963 1020 | Çocuk korumalı kapaklı topraklı priz | 120 | 15,90 ₺ |
| 5963 1021 | UPS kapaklı topraklı priz | 120 | 19,40 ₺ |
| 5963 1023 | İkili priz | 100 | 12,80 ₺ |
| 5963 1024 | İkili topraklı priz | 70 | 13,30 ₺ |
| TV/Radyo Grubu | | | |
| 5963 1030 | TV priz geçişli | 120 | 15,60 ₺ |
| 5963 1031 | TV priz sonlu | 120 | 15,60 ₺ |
| 5963 1032 | TV priz dirençsiz | 120 | 15,60 ₺ |
| 5963 1033 | Uydu prizi F konnektörlü geçişli | 120 | 21,20 ₺ |
| 5963 1034 | Uydu prizi F konnektörlü sonlu | 120 | 21,20 ₺ |
| 5963 1035 | TV - Radyo priz geçişli | 120 | 48,70 ₺ |
| 5963 1036 | TV - Radyo priz sonlu | 120 | 48,70 ₺ |
| 5963 1037 | TV - Sat priz geçişli | 120 | 50,20 ₺ |
| 5963 1038 | TV - Sat priz sonlu | 120 | 50,20 ₺ |

| Kod No | Cinsi | Koli Ad. | Keira Ahşap Serisi |
|-----------------------------|--------------------------------|----------|--------------------|
| iletişim Grubu | | | |
| 5963 1040 | Telefon prizi | 120 | 10,70 ₺ |
| 5963 1041 | Numeris telefon prizi (RJ11) | 120 | 12,50 ₺ |
| 5963 1042 | İkili numeris (RJ11) | 120 | 17,10 ₺ |
| 5963 1043 | Data numeris (RJ45CAT5-RJ11) | 120 | 35,20 ₺ |
| 5963 1044 | Data priz (RJ45CAT5) | 120 | 48,70 ₺ |
| 5963 1045 | İkili data priz (RJ45CAT5) | 120 | 53,30 ₺ |
| 5963 1046 | Data jaksız | 120 | 12,00 ₺ |
| 5963 1047 | Data priz (RJ45CAT6) | 120 | 48,70 ₺ |
| 5963 1048 | İkili data priz (RJ45CAT6) | 120 | 53,30 ₺ |
| 5963 1049 | Data - Numeris (RJ45CAT6-RJ11) | 120 | 35,20 ₺ |
| 5963 1050 | Müzik Yayın Prizi | 80 | 65,70 ₺ |
| 5963 1052 | VGA Prizi | 80 | 99,50 ₺ |
| 5963 1059 | Müzik yayın anahtarı | 80 | 47,50 ₺ |
| Dimmer Grubu | | | |
| 5963 1055 | Dimmer 600W | 80 | 40,40 ₺ |
| 5963 1056 | Dimmer 1000W | 80 | 43,70 ₺ |
| 5963 1057 | Dimmer vavien 600W | 80 | 75,80 ₺ |
| 5963 1058 | Dimmer RC 300W | 80 | 82,30 ₺ |
| Işıkli Anahtar Grubu | | | |
| 5963 1070 | Işıkli anahtar | 120 | 13,40 ₺ |
| 5963 1071 | Işıkli light | 120 | 13,80 ₺ |
| 5963 1072 | Işıkli komitatör | 120 | 15,00 ₺ |
| 5963 1073 | Işıkli vavien | 120 | 15,00 ₺ |
| 5963 1074 | Işıkli etiketli zil | 120 | 14,80 ₺ |
| 5963 1075 | Işıkli dimmer 600W | 80 | 42,10 ₺ |
| 5963 1076 | Işıkli dimmer 1000W | 80 | 45,20 ₺ |
| 5963 1077 | Işıkli dimmer vavien 600W | 80 | 71,00 ₺ |
| 5963 1078 | Işıkli dimmer RC 300W | 80 | 83,90 ₺ |
| Çerçeveler | | | |
| 5963 1081 | 2'li çerçeve yatay-dikey | 200 | 8,90 ₺ |
| 5963 1082 | 3'lü çerçeve yatay-dikey | 150 | 9,90 ₺ |
| 5963 1083 | 4'lü çerçeve yatay-dikey | 50 | 11,70 ₺ |
| 5963 1084 | 5'li çerçeve yatay-dikey | 50 | 13,30 ₺ |
| 5963 1085 | 6'lı çerçeve yatay-dikey | 50 | 14,90 ₺ |

Konfigürasyon: Kiraz: K23
Meşe: K22



Keira Cam-Corian



Keira Mermer Anahtar ve Priz Serisi



| Kod No | Cinsi | Koli Ad. | Keira Cam ve Mermer Serisi |
|-----------------------|--------------------------------------|----------|----------------------------|
| Anahtar Grubu | | | |
| 5963 1001 | Anahtar | 120 | 41,20 ₺ |
| 5963 1002 | Light | 120 | 41,60 ₺ |
| 5963 1003 | Kapı otomatığı | 120 | 41,60 ₺ |
| 5963 1004 | Zil anahtarı | 120 | 41,60 ₺ |
| 5963 1005 | Komitatör | 120 | 42,60 ₺ |
| 5963 1006 | Vavien | 120 | 42,60 ₺ |
| 5963 1007 | Permitatör | 120 | 44,90 ₺ |
| 5963 1008 | Komitatör vavien | 120 | 45,80 ₺ |
| 5963 1009 | Jaluzi anahtarı | 120 | 47,70 ₺ |
| 5963 1010 | Şofben anahtarı | 120 | 47,70 ₺ |
| Priz Grubu | | | |
| 5963 1014 | Priz | 120 | 41,20 ₺ |
| 5963 1015 | Topraklı priz | 120 | 42,50 ₺ |
| 5963 1016 | Çocuk korumalı topraklı priz | 120 | 45,50 ₺ |
| 5963 1017 | UPS topraklı priz | 120 | 44,90 ₺ |
| 5963 1018 | UPS çocuk korumalı topraklı priz | 120 | 45,20 ₺ |
| 5963 1019 | Kapaklı topraklı priz | 120 | 43,70 ₺ |
| 5963 1020 | Çocuk korumalı kapaklı topraklı priz | 120 | 47,20 ₺ |
| 5963 1021 | UPS kapaklı topraklı priz | 120 | 51,50 ₺ |
| TV/Radyo Grubu | | | |
| 5963 1030 | TV priz geçişli | 120 | 47,00 ₺ |
| 5963 1031 | TV priz sonlu | 120 | 47,00 ₺ |
| 5963 1032 | TV priz dirençsiz | 120 | 47,00 ₺ |
| 5963 1033 | Uydu prizi F komnektörü geçişli | 120 | 53,40 ₺ |
| 5963 1034 | Uydu prizi F komnektörü sonlu | 120 | 53,40 ₺ |
| 5963 1035 | TV - Radyo priz geçişli | 120 | 68,20 ₺ |
| 5963 1036 | TV - Radyo priz sonlu | 120 | 68,20 ₺ |
| 5963 1037 | TV - Sat priz geçişli | 120 | 87,00 ₺ |
| 5963 1038 | TV - Sat priz sonlu | 120 | 87,00 ₺ |

| Kod No | Cinsi | Koli Ad. | Keira Cam ve Mermer Serisi |
|-----------------------------|--------------------------------|----------|----------------------------|
| iletişim Grubu | | | |
| 5963 1040 | Telefon prizi | 120 | 41,20 ₺ |
| 5963 1041 | Numeris telefon prizi (RJ11) | 120 | 43,30 ₺ |
| 5963 1042 | İkili numeris (RJ11) | 120 | 48,70 ₺ |
| 5963 1043 | Data numeris (RJ45CAT5-RJ11) | 120 | 69,90 ₺ |
| 5963 1044 | Data priz (RJ45CAT5) | 120 | 68,20 ₺ |
| 5963 1045 | İkili data priz (RJ45CAT5) | 120 | 90,80 ₺ |
| 5963 1046 | Data jaksız | 120 | 42,60 ₺ |
| 5963 1047 | Data priz (RJ45CAT6) | 120 | 68,20 ₺ |
| 5963 1048 | İkili data priz (RJ45CAT6) | 120 | 90,80 ₺ |
| 5963 1049 | Data - Numeris (RJ45CAT6-RJ11) | 120 | 69,90 ₺ |
| 5963 1050 | Müzik Yayın Prizi | 80 | 94,60 ₺ |
| 5963 1052 | VGA Prizi | 80 | 110,40 ₺ |
| 5963 1059 | Müzik yayın anahtarı | 80 | 84,00 ₺ |
| Dimmer Grubu | | | |
| 5963 1055 | Dimmer 600W | 80 | 75,80 ₺ |
| 5963 1056 | Dimmer 1000W | 80 | 79,60 ₺ |
| 5963 1057 | Dimmer vavien 600W | 80 | 117,00 ₺ |
| 5963 1058 | Dimmer RC 300W | 80 | 124,60 ₺ |
| Işıkli Anahtar Grubu | | | |
| 5963 1070 | Işıkli anahtar | 120 | 44,40 ₺ |
| 5963 1071 | Işıkli light | 120 | 44,80 ₺ |
| 5963 1072 | Işıkli komitatör | 120 | 46,30 ₺ |
| 5963 1073 | Işıkli vavien | 120 | 46,30 ₺ |
| 5963 1074 | Işıkli etiketli zil | 120 | 45,90 ₺ |
| 5963 1075 | Işıkli dimmer 600W | 80 | 77,70 ₺ |
| 5963 1076 | Işıkli dimmer 1000W | 80 | 81,40 ₺ |
| 5963 1077 | Işıkli dimmer vavien 600W | 80 | 118,90 ₺ |
| 5963 1078 | Işıkli dimmer RC 300W | 80 | 126,30 ₺ |
| Çerçeveler | | | |
| 5963 1081 | 2'li çerçeve yatay-dikey | 200 | 43,20 ₺ |
| 5963 1082 | 3'lü çerçeve yatay-dikey | 150 | 46,90 ₺ |

Onyx Beyaz Anahtar ve Priz Serisi



Onyx Krem Anahtar ve Priz Serisi



| Kod No | Cinsi | Koli Ad. | Beyaz ve Krem Serisi |
|-----------------------|--------------------------------------|----------|----------------------|
| Anahtar Grubu | | | |
| 5963 3001 | Anahtar | 120 | 5,70 ₺ |
| 5963 3002 | Light | 120 | 6,00 ₺ |
| 5963 3003 | Kapı otomatığı | 120 | 6,00 ₺ |
| 5963 3004 | Zil anahtarı | 120 | 6,00 ₺ |
| 5963 3005 | Komitatör | 120 | 6,90 ₺ |
| 5963 3006 | Vavien | 120 | 6,90 ₺ |
| 5963 3007 | Permitatör | 120 | 8,90 ₺ |
| 5963 3008 | Komitatör vavien | 120 | 9,70 ₺ |
| 5963 3009 | Jaluzi anahtarı | 120 | 11,40 ₺ |
| 5963 3010 | Şofben anahtarı | 120 | 18,30 ₺ |
| 5963 3011 | 3'lü anahtar | 120 | 15,50 ₺ |
| Priz Grubu | | | |
| 5963 3014 | Priz | 120 | 5,70 ₺ |
| 5963 3015 | Topraklı priz | 120 | 6,80 ₺ |
| 5963 3016 | Çocuk korumalı topraklı priz | 120 | 9,20 ₺ |
| 5963 3017 | UPS topraklı priz | 120 | 8,90 ₺ |
| 5963 3018 | UPS çocuk korumalı topraklı priz | 120 | 9,20 ₺ |
| 5963 3019 | Kapaklı topraklı priz | 120 | 7,90 ₺ |
| 5963 3020 | Çocuk korumalı kapaklı topraklı priz | 120 | 10,90 ₺ |
| 5963 3021 | UPS kapaklı topraklı priz | 120 | 14,50 ₺ |
| 5963 3023 | İkili priz | 100 | 7,80 ₺ |
| 5963 3024 | İkili topraklı priz | 70 | 8,40 ₺ |
| TV/Radyo Grubu | | | |
| 5963 3030 | TV priz geçişi | 120 | 10,70 ₺ |
| 5963 3031 | TV priz sonlu | 120 | 10,70 ₺ |
| 5963 3032 | TV priz dirençsiz | 120 | 10,70 ₺ |
| 5963 3033 | Uydu prizi F komnektörlü geçişi | 120 | 16,10 ₺ |
| 5963 3034 | Uydu prizi F komnektörlü sonlu | 120 | 16,10 ₺ |
| 5963 3035 | TV - Radyo priz geçişi | 120 | 29,10 ₺ |
| 5963 3036 | TV - Radyo priz sonlu | 120 | 29,10 ₺ |
| 5963 3037 | TV - Sat priz geçişi | 120 | 45,10 ₺ |
| 5963 3038 | TV - Sat priz sonlu | 120 | 45,10 ₺ |

| Kod No | Cinsi | Koli Ad. | Beyaz ve Krem Serisi |
|-----------------------------|--------------------------------|----------|----------------------|
| İletişim Grubu | | | |
| 5963 3040 | Telefon prizi | 120 | 5,70 ₺ |
| 5963 3041 | Numeris telefon prizi (RJ11) | 120 | 7,60 ₺ |
| 5963 3042 | İkili numeris (RJ11) | 120 | 12,10 ₺ |
| 5963 3043 | Data numeris (RJ45CAT5-RJ11) | 120 | 30,30 ₺ |
| 5963 3044 | Data priz (RJ45CAT5) | 120 | 29,10 ₺ |
| 5963 3045 | İkili data priz (RJ45CAT5) | 120 | 48,30 ₺ |
| 5963 3046 | Data jaksız | 120 | 6,90 ₺ |
| 5963 3047 | Data priz (RJ45CAT6) | 120 | 29,10 ₺ |
| 5963 3048 | İkili data priz (RJ45CAT6) | 120 | 48,30 ₺ |
| 5963 3049 | Data - Numeris (RJ45CAT6-RJ11) | 120 | 30,30 ₺ |
| 5963 3050 | Müzik Yayın Prizi | 80 | 60,00 ₺ |
| 5963 3052 | VGA Prizi | 80 | 94,60 ₺ |
| 5963 3059 | Müzik yayın anahtarı | 80 | 42,60 ₺ |
| Dimmer Grubu | | | |
| 5963 3055 | Dimmer 600W | 80 | 35,50 ₺ |
| 5963 3056 | Dimmer 1000W | 80 | 38,60 ₺ |
| 5963 3057 | Dimmer vavien 600W | 80 | 70,90 ₺ |
| 5963 3058 | Dimmer RC 300W | 80 | 77,30 ₺ |
| İşıkli Anahtar Grubu | | | |
| 5963 3070 | İşıkli anahtar | 120 | 8,40 ₺ |
| 5963 3071 | İşıkli light | 120 | 8,80 ₺ |
| 5963 3072 | İşıkli komitatör | 120 | 10,10 ₺ |
| 5963 3073 | İşıkli vavien | 120 | 10,10 ₺ |
| 5963 3074 | İşıkli etiketli zil | 120 | 9,80 ₺ |
| 5963 3075 | İşıkli dimmer 600W | 80 | 37,10 ₺ |
| 5963 3076 | İşıkli dimmer 1000W | 80 | 40,30 ₺ |
| 5963 3077 | İşıkli dimmer vavien 600W | 80 | 72,50 ₺ |
| 5963 3078 | İşıkli dimmer RC 300W | 80 | 79,00 ₺ |
| Çerçeveler | | | |
| 5963 3081 | 2'li çerçeve yatay-dikey | 200 | 4,00 ₺ |
| 5963 3082 | 3'lü çerçeve yatay-dikey | 150 | 5,00 ₺ |
| 5963 3083 | 4'lü çerçeve yatay-dikey | 50 | 6,70 ₺ |
| 5963 3084 | 5'li çerçeve yatay-dikey | 50 | 8,30 ₺ |
| 5963 3085 | 6'lı çerçeve yatay-dikey | 50 | 9,90 ₺ |

Konfigürasyon: Beyaz: K0
Krem: K21



Onyx Füme Anahtar ve Priz Serisi



Füme: K25

Onyx Saten Anahtar ve Priz Serisi



Saten: K24

| Kod No | Cinsi | Koli Ad. | Onyx Metalik Seri |
|-----------------------|--------------------------------------|----------|-------------------|
| Anahtar Grubu | | | |
| 5963 3001 | Anahtar | 120 | 10,20 ₺ |
| 5963 3002 | Light | 120 | 10,60 ₺ |
| 5963 3003 | Kapı otomatığı | 120 | 10,60 ₺ |
| 5963 3004 | Zil anahtarı | 120 | 10,60 ₺ |
| 5963 3005 | Komitatör | 120 | 11,50 ₺ |
| 5963 3006 | Vavien | 120 | 11,50 ₺ |
| 5963 3007 | Permitatör | 120 | 13,60 ₺ |
| 5963 3008 | Komitatör vavien | 120 | 14,40 ₺ |
| 5963 3009 | Jaluzi anahtarı | 120 | 16,00 ₺ |
| 5963 3010 | Şofben anahtarı | 120 | 24,00 ₺ |
| 5963 3011 | 3'lü anahtar | 120 | 21,00 ₺ |
| Priz Grubu | | | |
| 5963 3014 | Priz | 120 | 10,20 ₺ |
| 5963 3015 | Topraklı priz | 120 | 11,40 ₺ |
| 5963 3016 | Çocuk korumalı topraklı priz | 120 | 14,00 ₺ |
| 5963 3017 | UPS topraklı priz | 120 | 13,60 ₺ |
| 5963 3018 | UPS çocuk korumalı topraklı priz | 120 | 13,80 ₺ |
| 5963 3019 | Kapaklı topraklı priz | 120 | 12,60 ₺ |
| 5963 3020 | Çocuk korumalı kapaklı topraklı priz | 120 | 15,60 ₺ |
| 5963 3021 | UPS kapaklı topraklı priz | 120 | 19,30 ₺ |
| 5963 3023 | İkili priz | 100 | 12,40 ₺ |
| 5963 3024 | İkili topraklı priz | 70 | 13,00 ₺ |
| TV/Radyo Grubu | | | |
| 5963 3030 | TV priz geçişli | 120 | 15,40 ₺ |
| 5963 3031 | TV priz sonlu | 120 | 15,40 ₺ |
| 5963 3032 | TV priz dirençsiz | 120 | 15,40 ₺ |
| 5963 3033 | Uydu prizi F komnektörlü geçişli | 120 | 21,00 ₺ |
| 5963 3034 | Uydu prizi F komnektörlü sonlu | 120 | 21,00 ₺ |
| 5963 3035 | TV - Radyo priz geçişli | 120 | 34,40 ₺ |
| 5963 3036 | TV - Radyo priz sonlu | 120 | 34,40 ₺ |
| 5963 3037 | TV - Sat priz geçişli | 120 | 51,10 ₺ |
| 5963 3038 | TV - Sat priz sonlu | 120 | 51,10 ₺ |

| Kod No | Cinsi | Koli Ad. | Onyx Metalik Seri |
|-----------------------------|--------------------------------|----------|-------------------|
| İletişim Grubu | | | |
| 5963 3040 | Telefon prizi | 120 | 10,20 ₺ |
| 5963 3041 | Numeris telefon prizi (RJ11) | 120 | 12,20 ₺ |
| 5963 3042 | İkili numeris (RJ11) | 120 | 16,80 ₺ |
| 5963 3043 | Data numeris (RJ45CAT5-RJ11) | 120 | 35,70 ₺ |
| 5963 3044 | Data priz (RJ45CAT5) | 120 | 34,40 ₺ |
| 5963 3045 | İkili data priz (RJ45CAT5) | 120 | 54,40 ₺ |
| 5963 3046 | Data jaksız | 120 | 11,50 ₺ |
| 5963 3047 | Data priz (RJ45CAT6) | 120 | 34,40 ₺ |
| 5963 3048 | İkili data priz (RJ45CAT6) | 120 | 54,40 ₺ |
| 5963 3049 | Data - Numeris (RJ45CAT6-RJ11) | 120 | 35,70 ₺ |
| 5963 3050 | Müzik Yayın Prizi | 80 | 67,10 ₺ |
| 5963 3052 | VGA Prizi | 80 | 104,00 ₺ |
| 5963 3059 | Müzik yayın anahtarı | 80 | 48,30 ₺ |
| Dimmer Grubu | | | |
| 5963 3055 | Dimmer 600W | 80 | 42,10 ₺ |
| 5963 3056 | Dimmer 1000W | 80 | 39,70 ₺ |
| 5963 3057 | Dimmer vavien 600W | 80 | 77,70 ₺ |
| 5963 3058 | Dimmer RC 300W | 80 | 84,50 ₺ |
| İşiklı Anahtar Grubu | | | |
| 5963 3070 | İşiklı anahtar | 120 | 13,20 ₺ |
| 5963 3071 | İşiklı light | 120 | 13,50 ₺ |
| 5963 3072 | İşiklı komitatör | 120 | 14,80 ₺ |
| 5963 3073 | İşiklı vavien | 120 | 14,80 ₺ |
| 5963 3074 | İşiklı etiketli zil | 120 | 14,40 ₺ |
| 5963 3075 | İşiklı dimmer 600W | 80 | 42,60 ₺ |
| 5963 3076 | İşiklı dimmer 1000W | 80 | 46,00 ₺ |
| 5963 3077 | İşiklı dimmer vavien 600W | 80 | 72,70 ₺ |
| 5963 3078 | İşiklı dimmer RC 300W | 80 | 86,10 ₺ |
| Çerçeveler | | | |
| 5963 3081 | 2'li çerçeve yatay-dikey | 200 | 8,40 ₺ |
| 5963 3082 | 3'lü çerçeve yatay-dikey | 150 | 9,50 ₺ |
| 5963 3083 | 4'lü çerçeve yatay-dikey | 50 | 11,20 ₺ |
| 5963 3084 | 5'li çerçeve yatay-dikey | 50 | 12,90 ₺ |
| 5963 3085 | 6'li çerçeve yatay-dikey | 50 | 14,70 ₺ |



Anahtar ve Prizler Pelsan

Onyx Kiraz Anahtar ve Priz Serisi



Kiraz: K23

Onyx Meşe Anahtar ve Priz Serisi

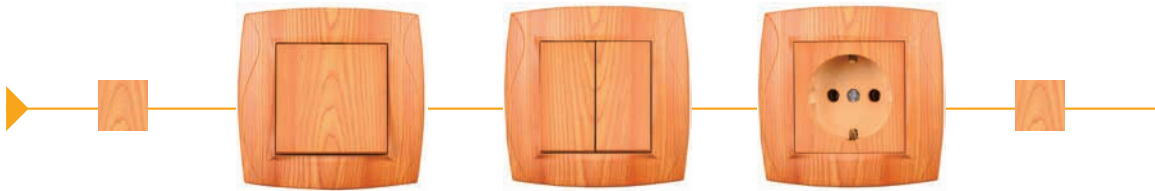

Meşe: K22

| Kod No | Cinsi | Koli Ad, | Onyx Aşşap Seri |
|-----------------------|--------------------------------------|----------|--------------------|
| Anahtar Grubu | | | |
| 5963 3001 | Anahtar | 120 | 10,70 ₺ |
| 5963 3002 | Light | 120 | 14,30 ₺ |
| 5963 3003 | Kapı otomatığı | 120 | 14,30 ₺ |
| 5963 3004 | Zil anahtarı | 120 | 14,30 ₺ |
| 5963 3005 | Komitatör | 120 | 15,60 ₺ |
| 5963 3006 | Vavien | 120 | 15,60 ₺ |
| 5963 3007 | Permitatör | 120 | 13,80 ₺ |
| 5963 3008 | Komitatör vavien | 120 | 14,80 ₺ |
| 5963 3009 | Jaluzi anahtarı | 120 | 16,30 ₺ |
| 5963 3010 | Şofben anahtarı | 120 | 24,10 ₺ |
| 5963 3011 | 3'lü anahtar | 120 | 21,20 ₺ |
| Priz Grubu | | | |
| 5963 3014 | Priz | 120 | 10,70 ₺ |
| 5963 3015 | Topraklı priz | 120 | 11,90 ₺ |
| 5963 3016 | Çocuk korumalı topraklı priz | 120 | 14,30 ₺ |
| 5963 3017 | UPS topraklı priz | 120 | 13,80 ₺ |
| 5963 3018 | UPS çocuk korumalı topraklı priz | 120 | 14,20 ₺ |
| 5963 3019 | Kapaklı topraklı priz | 120 | 12,90 ₺ |
| 5963 3020 | Çocuk korumalı kapaklı topraklı priz | 120 | 15,90 ₺ |
| 5963 3021 | UPS kapaklı topraklı priz | 120 | 19,40 ₺ |
| 5963 3023 | İkili priz | 100 | 12,80 ₺ |
| 5963 3024 | İkili topraklı priz | 70 | 13,30 ₺ |
| TV/Radyo Grubu | | | |
| 5963 3030 | TV priz geçişli | 120 | 15,60 ₺ |
| 5963 3031 | TV priz sonlu | 120 | 15,60 ₺ |
| 5963 3032 | TV priz dirençsiz | 120 | 15,60 ₺ |
| 5963 3033 | Uydu prizi F komnektörlü geçişli | 120 | 21,20 ₺ |
| 5963 3034 | Uydu prizi F komnektörlü sonlu | 120 | 21,20 ₺ |
| 5963 3035 | TV - Radyo priz geçişli | 120 | 48,70 ₺ |
| 5963 3036 | TV - Radyo priz sonlu | 120 | 48,70 ₺ |
| 5963 3037 | TV - Sat priz geçişli | 120 | 50,20 ₺ |
| 5963 3038 | TV - Sat priz sonlu | 120 | 50,20 ₺ |

| Kod No | Cinsi | Koli Ad, | Onyx Aşşap Seri |
|-----------------------------|--------------------------------|----------|--------------------|
| İletişim Grubu | | | |
| 5963 3040 | Telefon prizi | 120 | 10,70 ₺ |
| 5963 3041 | Numeris telefon prizi (RJ11) | 120 | 12,50 ₺ |
| 5963 3042 | İkili numeris (RJ11) | 120 | 17,10 ₺ |
| 5963 3043 | Data numeris (RJ45CAT5-RJ11) | 120 | 35,20 ₺ |
| 5963 3044 | Data priz (RJ45CAT5) | 120 | 48,70 ₺ |
| 5963 3045 | İkili data priz (RJ45CAT5) | 120 | 53,30 ₺ |
| 5963 3046 | Data jaksız | 120 | 12,00 ₺ |
| 5963 3047 | Data priz (RJ45CAT6) | 120 | 48,70 ₺ |
| 5963 3048 | İkili data priz (RJ45CAT6) | 120 | 53,30 ₺ |
| 5963 3049 | Data - Numeris (RJ45CAT6-RJ11) | 120 | 35,20 ₺ |
| 5963 3050 | Müzik Yayın Prizi | 80 | 65,70 ₺ |
| 5963 3052 | VGA Prizi | 80 | 99,50 ₺ |
| 5963 3059 | Müzik yayın anahtarı | 80 | 47,50 ₺ |
| Dimmer Grubu | | | |
| 5963 3055 | Dimmer 600W | 80 | 40,40 ₺ |
| 5963 3056 | Dimmer 1000W | 80 | 43,70 ₺ |
| 5963 3057 | Dimmer vavien 600W | 80 | 75,80 ₺ |
| 5963 3058 | Dimmer RC 300W | 80 | 82,30 ₺ |
| İşıkli Anahtar Grubu | | | |
| 5963 3070 | İşıkli anahtar | 120 | 13,40 ₺ |
| 5963 3071 | İşıkli light | 120 | 13,80 ₺ |
| 5963 3072 | İşıkli komitatör | 120 | 15,00 ₺ |
| 5963 3073 | İşıkli vavien | 120 | 15,00 ₺ |
| 5963 3074 | İşıkli etiketli zil | 120 | 14,80 ₺ |
| 5963 3075 | İşıkli dimmer 600W | 80 | 42,10 ₺ |
| 5963 3076 | İşıkli dimmer 1000W | 80 | 45,20 ₺ |
| 5963 3077 | İşıkli dimmer vavien 600W | 80 | 71,00 ₺ |
| 5963 3078 | İşıkli dimmer RC 300W | 80 | 83,90 ₺ |
| Çerçeveler | | | |
| 5963 3081 | 2'li çerçeve yatay-dikey | 200 | 8,90 ₺ |
| 5963 3082 | 3'lü çerçeve yatay-dikey | 150 | 9,90 ₺ |
| 5963 3083 | 4'lü çerçeve yatay-dikey | 50 | 11,70 ₺ |
| 5963 3084 | 5'li çerçeve yatay-dikey | 50 | 13,30 ₺ |
| 5963 3085 | 6'li çerçeve yatay-dikey | 50 | 14,90 ₺ |

Konfigürasyon: Kiraz: K23
Meşe: K22



Urla

Çocuk Korumalı Topraklı Grup Priz Serisi



| Kod No | Cinsi | Koli Ad. | Urla Seri |
|--------|-------|----------|-----------|
|--------|-------|----------|-----------|

Urla Çocuk Korumalı

| | | | |
|-----------|------------------------|----|---------|
| 5951 4433 | 3'lü 2m Çocuk Korumalı | 48 | 19,30 ₺ |
| 5951 4533 | 3'lü 3m Çocuk Korumalı | 48 | 22,50 ₺ |
| 5951 4633 | 3'lü 5m Çocuk Korumalı | 24 | 28,90 ₺ |

Urla Çocuk Korumalı

| | | | |
|-----------|------------------------|----|---------|
| 5951 4455 | 5'li 2m Çocuk Korumalı | 36 | 27,80 ₺ |
| 5951 4555 | 5'li 3m Çocuk Korumalı | 36 | 30,90 ₺ |
| 5951 4655 | 5'li 5m Çocuk Korumalı | 24 | 37,50 ₺ |

Urla Anahtarlı Çocuk Korumalı

| | | | |
|-----------|----------------------------------|----|---------|
| 5951 4733 | 3'lü Anahtarlı 2m Çocuk Korumalı | 48 | 25,10 ₺ |
| 5951 4833 | 3'lü Anahtarlı 3m Çocuk Korumalı | 48 | 28,30 ₺ |
| 5951 4933 | 3'lü Anahtarlı 5m Çocuk Korumalı | 24 | 34,80 ₺ |

Urla Anahtarlı Çocuk Korumalı

| | | | |
|-----------|----------------------------------|----|---------|
| 5951 4755 | 5'li Anahtarlı 2m Çocuk Korumalı | 36 | 33,60 ₺ |
| 5951 4855 | 5'li Anahtarlı 3m Çocuk Korumalı | 36 | 36,70 ₺ |
| 5951 4955 | 5'li Anahtarlı 5m Çocuk Korumalı | 24 | 43,40 ₺ |

UPS

Grup Priz Serisi



| Kod No | Cinsi | Koli Ad. | UPS Seri |
|--------|-------|----------|----------|
|--------|-------|----------|----------|

UPS Çeşme

| | | | |
|-----------|----------------------------------|-----|---------|
| 5951 1633 | 3'lü UPS Serisi Priz (klemensli) | 100 | 11,40 ₺ |
| 5951 1733 | 3'lü UPS Serisi Priz (2m) | 36 | 20,40 ₺ |
| 5951 1833 | 3'lü UPS Serisi Priz (3m) | 36 | 23,60 ₺ |
| 5951 1933 | 3'lü UPS Serisi Priz (5m) | 24 | 30,10 ₺ |

UPS Çeşme

| | | | |
|-----------|-----------------------------|-----|---------|
| 5951 1644 | 4'lü UPS Serisi (klemensli) | 100 | 17,40 ₺ |
| 5951 1744 | 4'lü UPS Serisi Priz (2m) | 36 | 26,40 ₺ |
| 5951 1844 | 4'lü UPS Serisi Priz (3m) | 36 | 29,60 ₺ |
| 5951 1944 | 4'lü UPS Serisi Priz (5m) | 24 | 36,00 ₺ |

UPS Çeşme

| | | | |
|-----------|----------------------------------|-----|---------|
| 5951 1666 | 6'lı UPS Serisi Priz (klemensli) | 100 | 22,70 ₺ |
| 5951 1766 | 6'lı UPS Serisi Priz (2m) | 36 | 31,70 ₺ |
| 5951 1866 | 6'lı UPS Serisi Priz (3m) | 36 | 34,90 ₺ |
| 5951 1966 | 6'lı UPS Serisi Priz (5m) | 24 | 41,30 ₺ |

UPS Foça Anahtarlı

| | | | |
|-----------|----------------------------------|-----|---------|
| 5951 2955 | 5'li UPS Serisi Priz (klemensli) | 100 | 27,20 ₺ |
| 5951 2965 | 5'li UPS Serisi Priz (2m) | 36 | 36,20 ₺ |
| 5951 2975 | 5'li UPS Serisi Priz (3m) | 36 | 39,30 ₺ |
| 5951 2985 | 5'li UPS Serisi Priz (5m) | 24 | 45,90 ₺ |

Çeşme

Grup Priz Serisi



| Kod No | Cinsi | Koli Ad. | Çeşme Seri |
|-----------|------------------|----------|------------|
| 5951 1012 | 2'li klemensli | 100 | 7,50 ₺ |
| 5951 1023 | 3'lü klemensli | 100 | 9,10 ₺ |
| 5951 1034 | 4'lü klemensli | 100 | 14,20 ₺ |
| 5951 1045 | 5'li klemensli | 100 | 17,30 ₺ |
| 5951 1056 | 6'lı klemensli | 100 | 18,10 ₺ |
| 5951 1112 | 2'li 2 m kablolu | 48 | 16,50 ₺ |
| 5951 1123 | 3'lü 2 m kablolu | 48 | 18,10 ₺ |
| 5951 1134 | 4'lü 2 m kablolu | 36 | 23,20 ₺ |
| 5951 1145 | 5'li 2 m kablolu | 36 | 26,30 ₺ |
| 5951 1156 | 6'lı 2 m kablolu | 36 | 27,10 ₺ |
| 5951 1212 | 2'li 3 m kablolu | 48 | 19,60 ₺ |
| 5951 1223 | 3'lü 3 m kablolu | 48 | 21,30 ₺ |
| 5951 1234 | 4'lü 3 m kablolu | 36 | 26,40 ₺ |
| 5951 1245 | 5'li 3 m kablolu | 36 | 29,40 ₺ |
| 5951 1256 | 6'lı 3 m kablolu | 36 | 30,30 ₺ |
| 5951 1312 | 2'li 5 m kablolu | 24 | 26,30 ₺ |
| 5951 1323 | 3'lü 5 m kablolu | 24 | 27,80 ₺ |
| 5951 1334 | 4'lü 5 m kablolu | 24 | 32,80 ₺ |
| 5951 1345 | 5'li 5 m kablolu | 24 | 36,00 ₺ |
| 5951 1356 | 6'lı 5 m kablolu | 24 | 36,70 ₺ |

Foça

Anahtarlı Grup Priz Serisi



| Kod No | Cinsi | Koli Ad. | Foça Seri |
|-----------|----------------------------|----------|-----------|
| 5951 3022 | 2'li klemensli anahtarlı | 100 | 13,40 ₺ |
| 5951 3033 | 3'lü klemensli anahtarlı | 100 | 15,00 ₺ |
| 5951 3044 | 4'lü klemensli anahtarlı | 100 | 20,10 ₺ |
| 5951 3055 | 5'li klemensli anahtarlı | 100 | 23,20 ₺ |
| 5951 3066 | 6'lı klemensli anahtarlı | 50 | 24,00 ₺ |
| 5951 3122 | 2'li 2 m kablolu anahtarlı | 48 | 22,40 ₺ |
| 5951 3133 | 3'lü 2 m kablolu anahtarlı | 48 | 24,00 ₺ |
| 5951 3144 | 4'lü 2 m kablolu anahtarlı | 36 | 29,00 ₺ |
| 5951 3155 | 5'li 2 m kablolu anahtarlı | 36 | 32,10 ₺ |
| 5951 3166 | 6'lı 2 m kablolu anahtarlı | 36 | 32,90 ₺ |
| 5951 3222 | 2'li 3 m kablolu anahtarlı | 48 | 25,50 ₺ |
| 5951 3233 | 3'lü 3 m kablolu anahtarlı | 48 | 27,20 ₺ |
| 5951 3244 | 4'lü 3 m kablolu anahtarlı | 36 | 32,20 ₺ |
| 5951 3255 | 5'li 3 m kablolu anahtarlı | 36 | 35,20 ₺ |
| 5951 3266 | 6'lı 3 m kablolu anahtarlı | 36 | 36,20 ₺ |
| 5951 3322 | 2'li 5 m kablolu anahtarlı | 24 | 32,10 ₺ |
| 5951 3333 | 3'lü 5 m kablolu anahtarlı | 24 | 33,60 ₺ |
| 5951 3344 | 4'lü 5 m kablolu anahtarlı | 24 | 38,70 ₺ |
| 5951 3355 | 5'li 5 m kablolu anahtarlı | 24 | 41,90 ₺ |
| 5951 3366 | 6'lı 5 m kablolu anahtarlı | 24 | 42,60 ₺ |

**Gerilim Korumalı Topraklı
Grup Priz**



Aksesuarlar

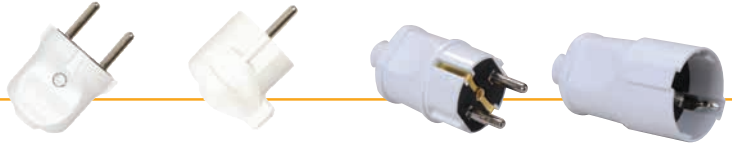

Fişler



Uzatma



| Kod No | Cinsi | Koli Ad. | Fiş Prizler Serisi |
|-----------|------------------------------------|----------|--------------------|
| 5951 9980 | 6'lı 2metre gerilim korumalı siyah | 20 | 51,50 ₺ |
| 5951 1063 | 3'lü grup fiş priz | 100 | 9,80 ₺ |
| 5951 1074 | 4'lü kare fiş priz | 100 | 12,10 ₺ |
| 5951 1083 | Trio fiş priz | 100 | 9,80 ₺ |

| Kod No | Cinsi | Koli Ad. | Aksesuar Serisi |
|-----------|---------------------------|----------|-----------------|
| 5951 1410 | Erkek fiş | 1000 | 2,30 ₺ |
| 5951 1420 | Topraklı erkek fiş | 500 | 2,70 ₺ |
| 5951 1430 | Topraklı dişi fiş | 250 | 2,80 ₺ |
| 5951 1450 | Topraklı erkek fiş L tipi | 500 | 2,70 ₺ |

| Kod No | Cinsi | Koli Ad. | Uzatma Kabloları Serisi |
|-----------|--------------------------|----------|-------------------------|
| 5951 1510 | 3 metre uzatma (3x1 mm) | 50 | 23,50 ₺ |
| 5951 1520 | 5 metre uzatma (3x1 mm) | 50 | 31,80 ₺ |
| 5951 1530 | 10 metre uzatma (3x1 mm) | 25 | 61,00 ₺ |

Kent 35



IP 65 ☺

| Kod No | Özellikler | Koli Adedi | Fiyat |
|-----------|---------------|------------|----------|
| 5730 5600 | Kent 35 2xE27 | 3 | 55,00 \$ |

Hisar

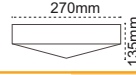

IP 65 ☺

| Kod No | Özellikler | Koli Adedi | Fiyat |
|-----------|-------------|------------|----------|
| 5730 5750 | Hisar 2xE27 | 6 | 25,00 \$ |

Polo 4

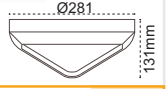

IP 44 ☺

| Kod No | Özellikler | Koli Adedi | Fiyat |
|-----------|------------|------------|----------|
| 5730 5550 | Polo 4 E27 | 8 | 19,00 \$ |

Miro

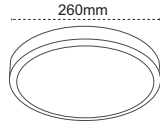

IP 40 ☺

| Kod No | Özellikler | Koli Adedi | Fiyat |
|-----------|-----------------------------|------------|----------|
| 5610 6440 | Miro S Tavan Armatürü 2XE27 | 12 | 25,00 \$ |

Dossi

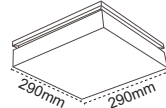
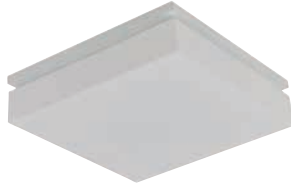

IP 40 ☺

| Kod No | Özellikler | Koli Adedi | Fiyat |
|-----------|----------------------------|------------|----------|
| 5732 8430 | Dossi LEDli Tavan Armatürü | 12 | 35,80 \$ |

Siperli Tavan



IP 44 ☺

| Kod No | Özellikler | Koli Adedi | Fiyat |
|-----------|-------------------------------|------------|----------|
| 5730 5280 | Siperli Tavan Armatürü 26 Gri | 6 | 15,00 \$ |

Piero 1

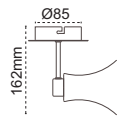

IP 20 ☺

| Kod No | Özellikler | Koli Adedi | Fiyat |
|-----------|-------------------------|------------|---------|
| 5812 5110 | Piero 1 Dekoratif Aplik | 1 | 9,00 \$ |

Piero 2

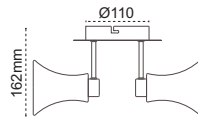

IP 20 ☺

| Kod No | Özellikler | Koli Adedi | Fiyat |
|-----------|-------------------------|------------|----------|
| 5812 5210 | Piero 2 Dekoratif Aplik | 12 | 17,00 \$ |

Piero 4



IP 20 ☺

| Kod No | Özellikler | Koli Adedi | Fiyat |
|-----------|----------------|------------|----------|
| 5812 5410 | Piero 4 Sarkit | 4 | 45,00 \$ |

Costa 1



IP 20 ☺

| Kod No | Özellikler | Koli Adedi | Fiyat |
|-----------|-------------------------------|------------|---------|
| 5812 6110 | Costa 1 Beyaz Dekoratif Aplik | 24 | 7,00 \$ |

Costa 2

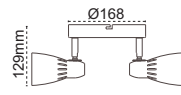

IP 20 ☺

| Kod No | Özellikler | Koli Adedi | Fiyat |
|-----------|-------------------------------|------------|----------|
| 5812 6210 | Costa 2 Beyaz Dekoratif Aplik | 12 | 15,85 \$ |

Costa 3

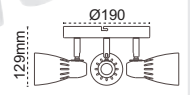

IP 20 ☺

| Kod No | Özellikler | Koli Adedi | Fiyat |
|-----------|-------------------------------|------------|----------|
| 5812 6310 | Costa 3 Beyaz Dekoratif Aplik | 6 | 21,15 \$ |

Dekart

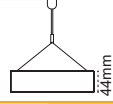

IP 20 ⊕

| Kod No | Özellikler | Koli Adedi | Fiyat |
|-----------|---------------------------|------------|----------|
| 5610 1022 | Dekart Dekoratif 2X28W T5 | 1 | 90,00 \$ |

Menart

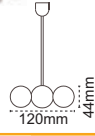

IP 20 ⊕

| Kod No | Özellikler | Koli Adedi | Fiyat |
|-----------|---------------------------|------------|----------|
| 5610 5012 | Menart Dekoratif 2X28W T5 | 1 | 53,00 \$ |

Artemis

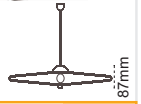

IP 20 ⊕

| Kod No | Özellikler | Koli Adedi | Fiyat |
|-----------|----------------------------|------------|-----------|
| 5610 2032 | Artemis Dekoratif 3X35W T5 | 1 | 100,00 \$ |

Delta

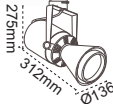

IP 44 ⊕

| Kod No | Özellikler | Koli Adedi | Fiyat |
|-----------|------------------------------|------------|----------|
| 5816 1420 | Delta Ray Spot Boş Beyaz G12 | 6 | 39,60 \$ |

Zeta



IP 44 ⊕

| Kod No | Özellikler | Koli Adedi | Fiyat |
|-----------|---------------------------|------------|----------|
| 5816 1000 | Zeta Ray Spot Gri Boş G12 | 8 | 14,15 \$ |

Beta

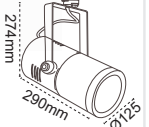

IP 44 ⊕

| Kod No | Özellikler | Koli Adedi | Fiyat |
|-----------|-------------------------------|------------|----------|
| 5816 1210 | Beta Raylı Spot Siyah Boş G12 | 8 | 32,50 \$ |

Kappa

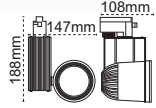

IP 44 ⊕

| Kod No | Özellikler | Koli Adedi | Fiyat |
|-----------|--------------------------|------------|----------|
| 5999 5080 | Kappa Ray Spot 30W 3000K | 8 | 62,10 \$ |

Theta

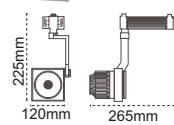

IP 44 ⊕

| Kod No | Özellikler | Koli Adedi | Fiyat |
|-----------|-----------------------------------|------------|-------|
| 5616 2451 | Theta LEDli Ray Spot 23W 4000K 12 | 45,00 \$ | |

Divya

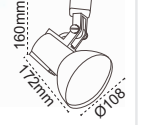

IP 44 ⊕

| Kod No | Özellikler | Koli Adedi | Fiyat |
|-----------|--------------------------------|------------|----------|
| 5816 3110 | Divya Par30 Raylı Spot Gri E27 | 20 | 15,00 \$ |

Stella

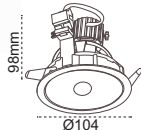

IP 20 ⊕

| Kod No | Özellikler | Koli Adedi | Fiyat |
|-----------|------------------------------------|------------|---------|
| 5816 3530 | Stella Ray Spot Beyaz Boş GX5,3 50 | | 6,30 \$ |

Orion

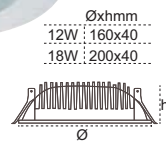

IP 40 ⊕

| Kod No | Özellikler | Koli Adedi | Fiyat |
|-----------|---------------------------|------------|----------|
| 5616 2911 | Orion SMD LEDli 12W 6500K | 20 | 8,90 \$ |
| 5616 2921 | Orion SMD LEDli 18W 6500K | 20 | 13,20 \$ |
| 5616 2951 | Orion SMD LEDli 18W 3000K | 20 | 13,20 \$ |

Elektra

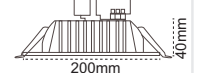
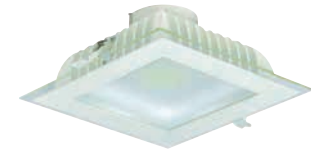

IP 40 ⊕

| Kod No | Özellikler | Koli Adedi | Fiyat |
|-----------|-------------------------|------------|----------|
| 5616 2621 | Elektra LEDli 18W 6500K | 20 | 13,20 \$ |

Perle

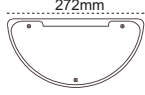

IP 44 ☺

| Kod No | Özellikler | Koli Adedi | Fiyat |
|-----------|-----------------------|------------|----------|
| 5730 9090 | Perle Duvar Aplik E27 | 20 | 10,00 \$ |

Işıközü

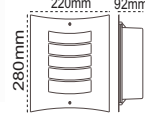

IP 44 ☺

| Kod No | Özellikler | Koli Adedi | Fiyat |
|-----------|---------------|------------|----------|
| 5730 3410 | Işıközü Aplik | 12 | 26,80 \$ |

Clupled



IP 44 ☺

| Kod No | Özellikler | Koli Adedi | Fiyat |
|-----------|--------------------------|------------|---------|
| 5732 5070 | Clupled Aplik Ilık Beyaz | 40 | 9,50 \$ |
| 5732 5020 | Clupled Aplik Mavi | 40 | 9,50 \$ |
| 5732 5010 | Clupled Aplik Beyaz | 40 | 9,50 \$ |

Netled

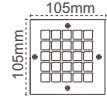

IP 65 ☺

| Kod No | Özellikler | Koli Adedi | Fiyat |
|-----------|-------------------------|------------|----------|
| 5732 9220 | Netled Duvar Gömme Mavi | 20 | 20,00 \$ |
| 5732 9320 | Netled Kare Mavi | 20 | 11,50 \$ |

Duvar Gömme 10

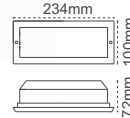

IP 44 ☺

| Kod No | Özellikler | Koli Adedi | Fiyat |
|-----------|----------------------------|------------|---------|
| 5730 9020 | Duvar Gömme 10 Gri Çerçeve | 18 | 8,50 \$ |

Kepled

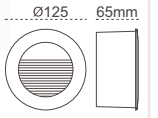

IP 20 ☺

| Kod No | Özellikler | Koli Adedi | Fiyat |
|-----------|-------------------------|------------|----------|
| 5732 9120 | Kepled Duvar Gömme Mavi | 18 | 14,80 \$ |

Yer Gömme 20

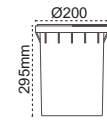

IP 65 ☺

| Kod No | Özellikler | Koli Adedi | Fiyat |
|-----------|---------------------|------------|-----------|
| 5730 9210 | Yer Gömme 20 Boş | 1 | 31,00 \$ |
| 5615 4101 | Yer Gömme 12X1W Boş | 1 | 162,80 \$ |

Yer Gömme 25

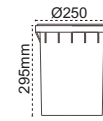

IP 65 ☺

| Kod No | Özellikler | Koli Adedi | Fiyat |
|-----------|-----------------------------|------------|----------|
| 5730 9240 | Yer Gömme Asimetrik G12 Boş | 1 | 90,00 \$ |

Yer Gömme Kare

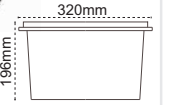
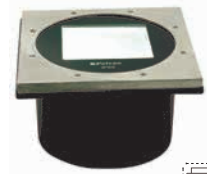

IP 65 ☺

| Kod No | Özellikler | Koli Adedi | Fiyat |
|-----------|---------------------------------|------------|----------|
| 5730 9250 | Yer Gömme Kare Asimetrik RX7s 1 | 1 | 90,00 \$ |

Midiled 12 Yuvarlak Yer Gömme

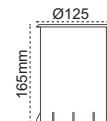

IP 65 ☺

| Kod No | Özellikler | Koli Adedi | Fiyat |
|-----------|---------------------------|------------|----------|
| 5732 1670 | Midiled 12 Yuvarlak 4000K | 18 | 25,60 \$ |

Midiled 12 Kare Yer Gömme

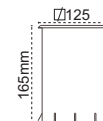

IP 65 ☺

| Kod No | Özellikler | Koli Adedi | Fiyat |
|-----------|----------------------|------------|----------|
| 5732 1820 | Midiled 12 Kare Mavi | 18 | 25,60 \$ |

Yağmur Altı

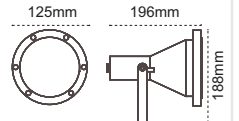

IP 65 ☺

| Kod No | Özellikler | Koli Adedi | Fiyat |
|-----------|-------------------|------------|----------|
| 5615 4001 | Yağmur Altı 12X1W | 1 | 66,20 \$ |

Stad Projektör Simetrik



| Kod No | Özellikler | Koli Adedi | Fiyat |
|-----------|---------------------|------------|-----------|
| 5611 4201 | Stad Simetrik 1000W | 1 | 651,00 \$ |
| 5611 4202 | Stad Simetrik 2000W | 1 | 661,00 \$ |

Shekelo Projektör



| Kod No | Özellikler | Koli Adedi | Fiyat |
|-----------|------------------------|------------|-----------|
| 5611 3810 | Shekelo E40 Boş | 1 | 108,52 \$ |
| 5611 3811 | Shekelo 250W E40 MH/SB | 1 | 180,00 \$ |
| 5611 3812 | Shekelo 400W E40 MH/SB | 1 | 113,00 \$ |

Marco Projektör Simetrik

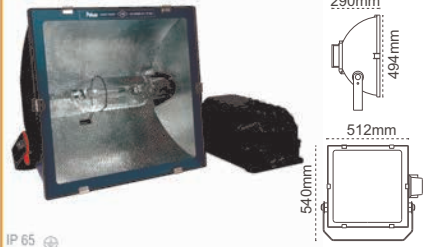

| Kod No | Özellikler | Koli Adedi | Fiyat |
|-----------|-------------------------|------------|-----------|
| 5611 2801 | Marco 1000W E40 MH/SB | 1 | 540,00 \$ |
| 5611 2802 | Marco 2000W E40 MH/380V | 1 | 551,00 \$ |

Bolivo Projektör Asimetrik



| Kod No | Özellikler | Koli Adedi | Fiyat |
|-----------|------------------------|------------|-----------|
| 5611 2511 | Bolivo 1000W E40 MH/SB | 1 | 446,00 \$ |
| 5611 2512 | Bolivo 2000W MHN-LA | 1 | 456,00 \$ |

Krono Projektör Asimetrik

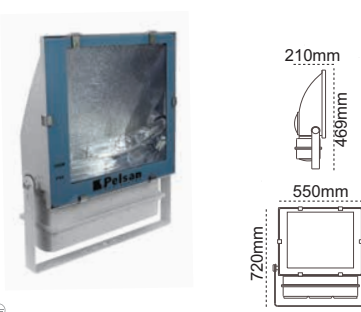

| Kod No | Özellikler | Koli Adedi | Fiyat |
|-----------|-----------------------|------------|-----------|
| 5611 2611 | Krono 1000W E40 MH/SB | 1 | 350,00 \$ |

Euro Projektör Simetrik

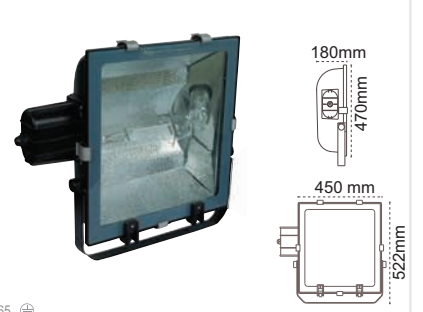

| Kod No | Özellikler | Koli Adedi | Fiyat |
|-----------|----------------------|------------|-----------|
| 5611 2701 | Euro 1000W E40 MH/SB | 1 | 378,00 \$ |

Pole Projektör Simetrik

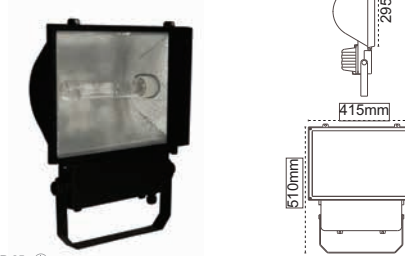

| Kod No | Özellikler | Koli Adedi | Fiyat |
|-----------|------------------|------------|-----------|
| 5611 1092 | Pole 400W E40 MH | 1 | 73,00 \$ |
| 5615 6211 | Pole 72 LEDli | 1 | 130,00 \$ |

Pesato Projektör Asimetrik

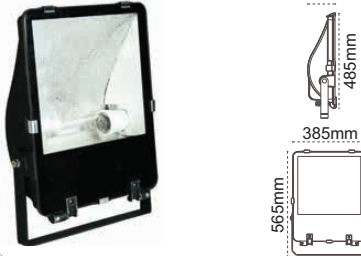

| Kod No | Özellikler | Koli Adedi | Fiyat |
|-----------|---------------------|------------|----------|
| 5611 3510 | Pesato 400W E40 Boş | 1 | 78,00 \$ |

Tünel Armatürü

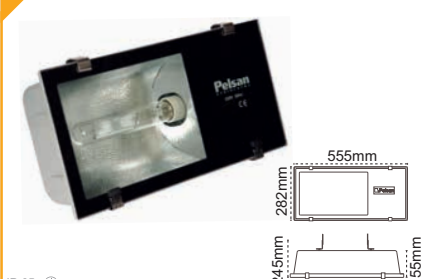

| Kod No | Özellikler | Koli Adedi | Fiyat |
|-----------|-------------------|------------|-----------|
| 5322 1011 | Tünel 250W E40 SB | 1 | 147,00 \$ |
| 5322 1012 | Tünel 400W E40 SB | 1 | 153,00 \$ |

Levo Projektör



| Kod No | Özellikler | Koli Adedi | Fiyat |
|-----------|------------------|------------|-----------|
| 5321 1711 | Levo 70W G12 MH | 1 | 58,75 \$ |
| 5321 1712 | Levo 150W G12 MH | 1 | 62,75 \$ |
| 5999 5071 | Levo LED 25W | 1 | 108,00 \$ |

RGB Projektör 36 LEDli

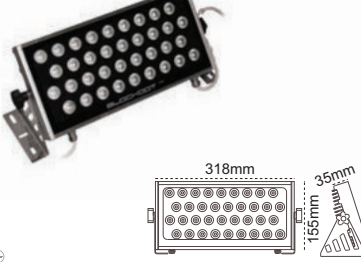

| Kod No | Özellikler | Koli Adedi | Fiyat |
|-----------|------------------------|------------|-----------|
| 5613 4660 | RGB Projektör 36 LEDli | 1 | 167,70 \$ |

LEDli Gömme Havuz RGB

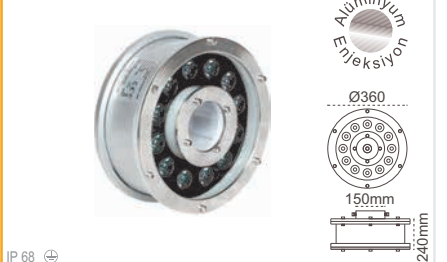

| Kod No | Özellikler | Koli Adedi | Fiyat |
|-----------|---------------------------|------------|-----------|
| 5412 1270 | 12W LEDli Gömme Havuz RGB | 1 | 102,00 \$ |

Wallwasher 6 LEDli

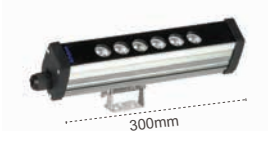

IP 65 ☺

| Kod No | Özellikler | Koli Adedi | Fiyat |
|-----------|---------------------|------------|----------|
| 5614 0211 | 6 LEDli 30cm 4000K | 1 | 38,00 \$ |
| 5614 0211 | 6 LEDli 30cm 6500K | 1 | 38,00 \$ |
| 5613 0210 | Wallwasher 9W 6500K | 1 | 38,00 \$ |

Wallwasher 18 LEDli

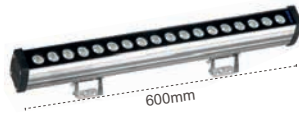

IP 65 ☺

| Kod No | Özellikler | Koli Adedi | Fiyat |
|-----------|---------------------|------------|----------|
| 5614 0611 | 18 LEDli 50cm Amber | 1 | 60,00 \$ |

Wallwasher 30 LEDli

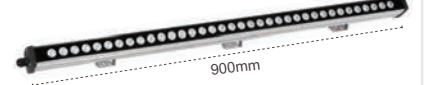

IP 65 ☺

| Kod No | Özellikler | Koli Adedi | Fiyat |
|-----------|---------------------|------------|----------|
| 5614 0810 | 30 LEDli 80cm 6500K | 1 | 65,00 \$ |

Corona



IP 54 ☺

| Kod No | Özellikler | Koli Adedi | Fiyat |
|-----------|----------------------|------------|-----------|
| 5616 3230 | Corona Aplik 6W | 1 | 100,00 \$ |
| 5616 3220 | Corona Bolard LED 6W | 1 | 80,00 \$ |

Teak



IP 44 ☺

| Kod No | Özellikler | Koli Adedi | Fiyat |
|-----------|---------------|------------|----------|
| 5730 4660 | Teak Aplik | 1 | 55,00 \$ |
| 5730 2660 | Teak Set Üstü | 1 | 45,00 \$ |

Işıglas

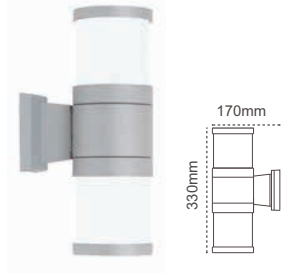

IP 44 ☺

| Kod No | Özellikler | Koli Adedi | Fiyat |
|-----------|-----------------|------------|----------|
| 5730 4630 | Işıglas 1 Aplik | 12 | 22,00 \$ |
| 5730 4640 | Işıglas 2 Aplik | 8 | 30,00 \$ |
| 5730 8540 | Işıglas 3 Aplik | 4 | 40,00 \$ |

Işıled 2

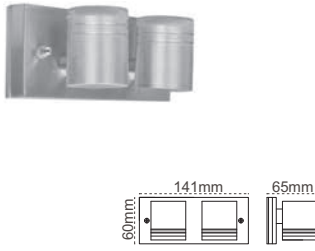

IP 44 ☺

| Kod No | Özellikler | Koli Adedi | Fiyat |
|-----------|---------------------|------------|----------|
| 5732 4070 | Işıled 2 Ilık Beyaz | 24 | 12,00 \$ |
| 5732 4020 | Işıled 2 Mavi | 24 | 12,00 \$ |

Işıled 3

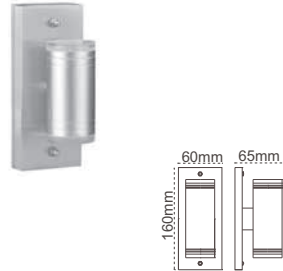

IP 44 ☺

| Kod No | Özellikler | Koli Adedi | Fiyat |
|-----------|---------------|------------|----------|
| 5732 4220 | Işıled 3 Mavi | 24 | 12,00 \$ |

Hatled

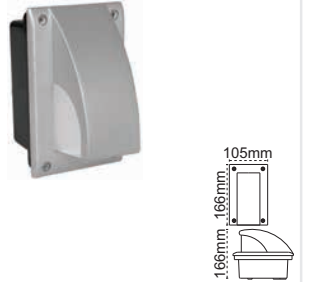

IP 44 ☺

| Kod No | Özellikler | Koli Adedi | Fiyat |
|-----------|-------------------------|------------|----------|
| 5732 9070 | Hatled Aplik Ilık Beyaz | 12 | 14,00 \$ |
| 5732 9020 | Hatled Aplik Mavi | 12 | 14,00 \$ |

Lilyum 2' li Direk



IP 54 ☺

| Kod No | Özellikler | Koli Adedi | Fiyat |
|-----------|--------------------|------------|-----------|
| 5731 5310 | Lilyum 2' li Direk | 1 | 200,00 \$ |

Açelya 3' lü Direk



IP 54 ☺

| Kod No | Özellikler | Koli Adedi | Fiyat |
|-----------|--------------------------|------------|-----------|
| 5731 5110 | Açelya 3' lü Döküm Direk | 1 | 180,00 \$ |

Verde & Sparta



IP 65 ☺

| Kod No | Özellikler | Koli Adedi | Fiyat |
|-----------|------------------|------------|-----------|
| 5616 5410 | Verde LEDli 68W | 1 | 945,00 \$ |
| 5740 1131 | Sparta 150W Rx7s | 1 | 450,00 \$ |

Spiral Lamba E14

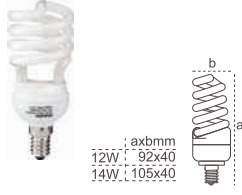

| Kod No | Özellikler | Koli Adedi | Fiyat |
|-----------|---------------|------------|---------|
| 5984 3430 | 8W E14 6400K | 100 | 1,15 \$ |
| 5984 3540 | 12W E14 2700K | 100 | 1,15 \$ |
| 5984 2700 | 14W E14 2700K | 100 | 1,15 \$ |
| 5984 2750 | 14W E14 6400K | 100 | 1,15 \$ |
| 5984 2210 | 9W G9 2700K | 100 | 1,15 \$ |

Spiral Lamba E27



| Kod No | Özellikler | Koli Adedi | Fiyat |
|-----------|---------------|------------|---------|
| 5984 3520 | 12W E27 2700K | 100 | 1,15 \$ |
| 5984 2710 | 14W E27 2700K | 100 | 1,15 \$ |
| 5984 2760 | 14W E27 6400K | 100 | 1,15 \$ |
| 5984 2810 | 15W E27 2700K | 100 | 1,15 \$ |

Spiral Lamba E27

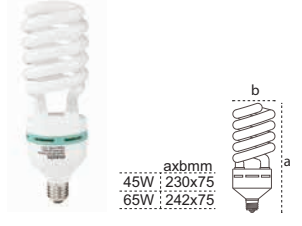

| Kod No | Özellikler | Koli Adedi | Fiyat |
|-----------|---------------|------------|---------|
| 5984 3280 | 45W E27 2700K | 25 | 5,30 \$ |
| 5984 3640 | 65W E27 2700K | 25 | 7,10 \$ |

35W T5 Lamba

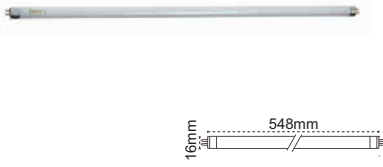

| Kod No | Özellikler | Koli Adedi | Fiyat |
|-----------|-----------------------|------------|---------|
| 5980 6060 | 35W T5 Floresan 4000K | 100 | 3,10 \$ |

18W T8 Lamba

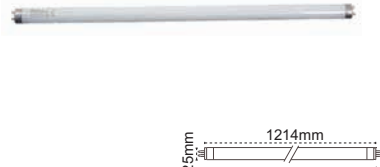

| Kod No | Özellikler | Koli Adedi | Fiyat |
|-----------|------------------------|------------|---------|
| 5980 8420 | 18W T8 Floresan 12000K | 25 | 0,83 \$ |

PLC Lamba

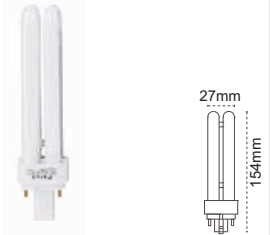

| Kod No | Özellikler | Koli Adedi | Fiyat |
|-----------|-----------------------|------------|---------|
| 5980 1540 | 26W PLC 4000K 4 Pinli | 100 | 1,00 \$ |
| 5980 1530 | 18W PLC 4000K 4 Pinli | 100 | 1,00 \$ |
| 5980 1120 | 18W PLC 6400K | 100 | 1,00 \$ |
| 5980 1220 | 10W PLC 6400K | 100 | 1,00 \$ |
| 5980 1420 | 13W PLC 6400K | 100 | 1,00 \$ |
| 5980 1430 | 26W PLC 6400K | 100 | 1,00 \$ |

Eko Halojen Lamba



| Kod No | Özellikler | Koli Adedi | Fiyat |
|-----------|---------------------|------------|---------|
| 5983 2280 | 42W E14 Şeffaf Buji | 100 | 0,60 \$ |
| 5983 2270 | 28W E14 Şeffaf Buji | 100 | 0,60 \$ |

Mare Beyaz Dikey Downlight



| Kod No | Özellikler | Koli Adedi | Fiyat |
|-----------|------------|------------|---------|
| 5512 7040 | 3" E27 Boş | 50 | 2,50 \$ |
| 5512 7080 | 5" E27 Boş | 20 | 3,50 \$ |
| 5512 7100 | 6" E27 Boş | 20 | 4,50 \$ |

Mare Beyaz Yatay Downlight



| Kod No | Özellikler | Koli Adedi | Fiyat |
|-----------|---------------|------------|---------|
| 5512 7160 | 6" Y2 E27 Boş | 20 | 6,00 \$ |
| 5512 7180 | 8" Y2 E27 Boş | 12 | 9,00 \$ |

Sarin Downlight Camsız



| Kod No | Özellikler | Koli Adedi | Fiyat |
|-----------|---------------|------------|---------|
| 5512 9100 | 5" E27 Camsız | 20 | 4,80 \$ |
| 5512 9240 | 8" G24 Camsız | 12 | 8,30 \$ |

Sarin Downlight Camlı

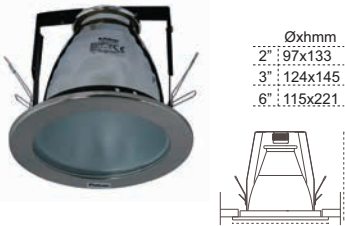

| Kod No | Özellikler | Koli Adedi | Fiyat |
|-----------|---------------------|------------|----------|
| 5512 4510 | 2" Y2 G24 Camlı Boş | 50 | 2,50 \$ |
| 5512 4520 | 3" Y2 G24 Camlı Boş | 50 | 6,00 \$ |
| 5512 4570 | 6" Y2 G24 Camlı Boş | 20 | 10,00 \$ |

Sorto Downlight



| Kod No | Özellikler | Koli Adedi | Fiyat |
|-----------|---------------|------------|----------|
| 5512 8070 | 5" G24 Boş | 20 | 8,00 \$ |
| 5512 8110 | 6" Y1 G24 Boş | 20 | 10,00 \$ |
| 5512 8130 | 8" Y1 G24 Boş | 12 | 10,50 \$ |

| Kod No | Sayfa | Sıra | Kod No | Sayfa | Sıra | Kod No | Sayfa | Sıra | Kod No | Sayfa | Sıra | Kod No | Sayfa | Sıra | Kod No | Sayfa | Sıra |
|-----------------|-------|------|------------------|-------|------|------------------|-------|------|------------------|-------|------|------------------|-------|------|------------------|-------|------|
| 3035 451 | 57 | 6 | 4201 816 | 35 | 9 | 5014 6022 | 12 | 5 | 5024 6140 | 35 | 5 | 5321 1801 | 52 | 7 | 5513 5310 | 31 | 2 |
| 3110 102 | 80 | 6 | 4201 817 | 35 | 9 | 5014 6032 | 12 | 5 | 5024 6142 | 35 | 6 | 5321 1802 | 52 | 7 | 5513 5320 | 31 | 4 |
| 3110 103 | 80 | 6 | 4201 821 | 35 | 11 | 5014 6502 | 12 | 1 | 5024 6150 | 35 | 5 | 5321 1901 | 52 | 6 | 5513 5330 | 30 | 6 |
| 3110 112 | 80 | 6 | 4201 822 | 35 | 11 | 5014 7252 | 12 | 4 | 5024 6152 | 35 | 6 | 5321 1902 | 52 | 6 | 5513 5340 | 30 | 3 |
| 3110 113 | 80 | 6 | 4301 642 | 78 | 5 | 5014 7262 | 12 | 4 | 5055 7352 | 45 | 3 | 5322 1011 | 52 | 4 | 5513 5350 | 31 | 1 |
| 3110 115 | 80 | 6 | 4301 652 | 78 | 5 | 5014 7272 | 12 | 4 | 5055 7362 | 45 | 3 | 5322 1011 | 4 | 9 | 5513 5390 | 30 | 7 |
| 3110 120 | 80 | 5 | 4301 662 | 78 | 5 | 5014 7382 | 12 | 6 | 5061 1110 | 39 | 7 | 5322 1012 | 52 | 4 | 5513 5410 | 31 | 7 |
| 3110 122 | 80 | 5 | 4301 672 | 78 | 5 | 5014 7392 | 12 | 6 | 5061 1170 | 39 | 4 | 5322 1012 | 4 | 8 | 5513 5420 | 31 | 7 |
| 3110 201 | 80 | 5 | 4301 682 | 78 | 5 | 5014 7402 | 12 | 6 | 5061 1200 | 39 | 8 | 5412 1270 | 70 | 9 | 5513 5550 | 30 | 8 |
| 3110 310 | 25 | 6 | 4301 692 | 78 | 5 | 5014 8532 | 12 | 7 | 5061 1210 | 39 | 8 | 5412 1270 | 4 | 12 | 5514 1060 | 38 | 5 |
| 3110 312 | 25 | 6 | 5011 0832 | 13 | 3 | 5014 8542 | 12 | 7 | 5061 1220 | 39 | 8 | 5413 1030 | 27 | 11 | 5514 1060 | 41 | 6 |
| 3110 335 | 25 | 7 | 5011 0842 | 13 | 3 | 5014 9882 | 12 | 8 | 5061 1230 | 39 | 8 | 5413 1100 | 27 | 12 | 5514 1110 | 38 | 3 |
| 3110 339 | 25 | 5 | 5011 1002 | 13 | 3 | 5014 9892 | 12 | 8 | 5061 1260 | 39 | 2 | 5413 2010 | 32 | 4 | 5514 1120 | 38 | 2 |
| 3110 351 | 25 | 7 | 5012 9012 | 35 | 2 | 5017 9002 | 42 | 1 | 5061 1270 | 39 | 3 | 5413 2011 | 32 | 4 | 5514 1130 | 38 | 1 |
| 3110 352 | 25 | 7 | 5012 9032 | 35 | 2 | 5017 9012 | 42 | 1 | 5061 1290 | 39 | 1 | 5413 2014 | 32 | 2 | 5514 1140 | 38 | 4 |
| 3110 353 | 25 | 7 | 5012 9040 | 35 | 1 | 5017 9022 | 42 | 1 | 5061 1310 | 39 | 9 | 5413 2113 | 32 | 1 | 5514 1140 | 41 | 5 |
| 3110 354 | 25 | 5 | 5012 9042 | 35 | 2 | 5017 9032 | 42 | 1 | 5061 1380 | 39 | 5 | 5413 2114 | 32 | 3 | 5610 1022 | 2 | 1 |
| 3110 355 | 25 | 6 | 5012 9062 | 35 | 2 | 5019 5212 | 42 | 3 | 5061 1390 | 39 | 6 | 5470 1131 | 5 | 12 | 5610 2032 | 2 | 3 |
| 3110 356 | 25 | 5 | 5012 9082 | 35 | 2 | 5019 5222 | 42 | 3 | 5118 2020 | 19 | 3 | 5511 2391 | 79 | 4 | 5610 2110 | 34 | 1 |
| 3110 361 | 25 | 7 | 5012 9092 | 35 | 2 | 5021 1530 | 37 | 4 | 5118 4011 | 19 | 2 | 5511 2401 | 79 | 4 | 5610 2110 | 42 | 4 |
| 3110 362 | 25 | 7 | 5012 9292 | 35 | 2 | 5021 1540 | 37 | 4 | 5118 4021 | 19 | 2 | 5511 2431 | 79 | 3 | 5610 2120 | 34 | 1 |
| 3110 364 | 25 | 5 | 5012 9300 | 35 | 1 | 5021 1550 | 37 | 4 | 5118 4211 | 18 | 2 | 5511 2441 | 79 | 3 | 5610 2120 | 42 | 4 |
| 3110 365 | 25 | 6 | 5012 9302 | 35 | 2 | 5021 1560 | 37 | 4 | 5118 4221 | 18 | 2 | 5511 2451 | 79 | 3 | 5610 2130 | 34 | 1 |
| 3120 106 | 80 | 3 | 5012 9420 | 35 | 1 | 5021 1570 | 37 | 4 | 5118 4231 | 18 | 2 | 5511 2461 | 79 | 3 | 5610 2130 | 42 | 4 |
| 3120 107 | 80 | 3 | 5012 9430 | 35 | 1 | 5021 1580 | 37 | 4 | 5118 4241 | 18 | 2 | 5511 2481 | 79 | 3 | 5610 2140 | 34 | 1 |
| 3140 101 | 80 | 1 | 5012 9440 | 35 | 1 | 5021 8220 | 36 | 5 | 5118 4411 | 19 | 1 | 5512 4510 | 6 | 11 | 5610 2140 | 42 | 4 |
| 3140 125 | 80 | 2 | 5012 9530 | 35 | 1 | 5021 8222 | 37 | 5 | 5118 4611 | 18 | 4 | 5512 4520 | 6 | 11 | 5610 2170 | 34 | 3 |
| 3140 132 | 80 | 1 | 5014 1912 | 12 | 5 | 5021 8240 | 36 | 6 | 5118 4621 | 18 | 4 | 5512 4570 | 6 | 11 | 5610 2170 | 42 | 5 |
| 3140 141 | 80 | 2 | 5014 1922 | 12 | 5 | 5021 8242 | 37 | 5 | 5211 1010 | 57 | 3 | 5512 7040 | 6 | 8 | 5610 2190 | 34 | 3 |
| 3170 131 | 80 | 4 | 5014 1932 | 12 | 5 | 5021 8260 | 36 | 5 | 5211 1014 | 57 | 3 | 5512 7080 | 6 | 8 | 5610 2190 | 42 | 5 |
| 3170 133 | 80 | 4 | 5014 2812 | 13 | 4 | 5021 8262 | 37 | 5 | 5211 1110 | 57 | 5 | 5512 7100 | 6 | 8 | 5610 3011 | 27 | 7 |
| 3180 197 | 10 | 11 | 5014 2822 | 13 | 4 | 5021 8280 | 36 | 6 | 5211 1115 | 57 | 5 | 5512 7160 | 6 | 9 | 5610 4011 | 27 | 8 |
| 3220 326 | 16 | 1 | 5014 2832 | 13 | 4 | 5021 8282 | 37 | 5 | 5211 1118 | 57 | 5 | 5512 7180 | 6 | 9 | 5610 5012 | 2 | 2 |
| 3220 335 | 16 | 2 | 5014 2862 | 13 | 4 | 5021 8450 | 36 | 5 | 5211 1613 | 57 | 2 | 5512 8070 | 6 | 12 | 5610 6440 | 1 | 4 |
| 3515 301 | 34 | 2 | 5014 2912 | 13 | 3 | 5021 8452 | 37 | 5 | 5211 1614 | 57 | 2 | 5512 8110 | 6 | 12 | 5610 6610 | 29 | 1 |
| 3515 301 | 42 | 6 | 5014 2922 | 13 | 3 | 5021 8460 | 36 | 6 | 5211 1616 | 57 | 2 | 5512 8130 | 6 | 12 | 5610 6611 | 29 | 3 |
| 4001 449 | 45 | 4 | 5014 2932 | 13 | 3 | 5021 8462 | 37 | 5 | 5211 3240 | 57 | 4 | 5512 9100 | 6 | 10 | 5610 6612 | 29 | 2 |
| 4001 468 | 45 | 4 | 5014 2972 | 44 | 4 | 5021 9562 | 37 | 6 | 5211 3242 | 57 | 4 | 5512 9240 | 6 | 10 | 5610 6613 | 29 | 4 |
| 4001 469 | 45 | 4 | 5014 2992 | 44 | 4 | 5021 9572 | 37 | 6 | 5211 3244 | 57 | 4 | 5513 1410 | 40 | 5 | 5610 6614 | 29 | 6 |
| 4065 111 | 57 | 6 | 5014 4022 | 12 | 1 | 5021 9582 | 37 | 6 | 5211 5011 | 57 | 1 | 5513 1420 | 40 | 8 | 5610 6615 | 29 | 5 |
| 4065 524 | 51 | 4 | 5014 4032 | 12 | 1 | 5021 9592 | 37 | 6 | 5211 5012 | 57 | 1 | 5513 1430 | 40 | 6 | 5610 6620 | 29 | 1 |
| 4065 525 | 51 | 3 | 5014 4042 | 12 | 1 | 5023 2031 | 17 | 2 | 5211 5013 | 57 | 1 | 5513 1440 | 40 | 7 | 5610 6621 | 29 | 2 |
| 4065 526 | 51 | 2 | 5014 4212 | 12 | 1 | 5023 2081 | 17 | 1 | 5211 5014 | 57 | 1 | 5513 1511 | 40 | 4 | 5610 6622 | 29 | 3 |
| 4065 527 | 51 | 1 | 5014 4402 | 13 | 6 | 5023 2111 | 17 | 3 | 5211 6011 | 56 | 3 | 5513 1512 | 40 | 2 | 5610 6624 | 29 | 1 |
| 4080 701 | 43 | 3 | 5014 4412 | 13 | 6 | 5023 2121 | 17 | 3 | 5211 6012 | 56 | 3 | 5513 1521 | 40 | 3 | 5610 6624 | 32 | 6 |
| 4080 702 | 43 | 4 | 5014 4422 | 13 | 6 | 5023 2131 | 17 | 3 | 5211 6211 | 56 | 2 | 5513 1522 | 40 | 2 | 5610 6625 | 29 | 2 |
| 4101 521 | 43 | 3 | 5014 4482 | 13 | 7 | 5023 2211 | 17 | 4 | 5211 6212 | 56 | 2 | 5513 1741 | 40 | 1 | 5610 6626 | 29 | 3 |
| 4101 522 | 43 | 4 | 5014 4492 | 13 | 7 | 5023 2221 | 17 | 4 | 5211 6313 | 56 | 1 | 5513 1751 | 40 | 1 | 5610 6630 | 29 | 1 |
| 4101 551 | 57 | 6 | 5014 4552 | 12 | 6 | 5023 2231 | 17 | 4 | 5211 6314 | 56 | 1 | 5513 4010 | 41 | 2 | 5610 6630 | 32 | 5 |
| 4101 561 | 57 | 6 | 5014 4562 | 12 | 6 | 5024 1020 | 35 | 7 | 5211 6411 | 56 | 4 | 5513 4020 | 41 | 2 | 5610 6631 | 29 | 2 |
| 4101 562 | 57 | 6 | 5014 4572 | 12 | 6 | 5024 1022 | 35 | 8 | 5212 1010 | 43 | 3 | 5513 4030 | 41 | 4 | 5610 6632 | 29 | 3 |
| 4101 571 | 57 | 6 | 5014 4762 | 12 | 3 | 5024 1030 | 35 | 7 | 5212 1121 | 43 | 4 | 5513 4040 | 41 | 4 | 5610 6640 | 29 | 1 |
| 4101 572 | 57 | 6 | 5014 4772 | 12 | 3 | 5024 1032 | 35 | 8 | 5212 1191 | 43 | 4 | 5513 4110 | 41 | 3 | 5610 6641 | 29 | 3 |
| 4101 574 | 57 | 6 | 5014 4782 | 12 | 3 | 5024 1210 | 35 | 5 | 5212 1201 | 43 | 4 | 5513 4120 | 41 | 3 | 5610 6642 | 29 | 2 |
| 4201 085 | 7 | 3 | 5014 4882 | 44 | 4 | 5024 1212 | 35 | 6 | 5212 4011 | 18 | 1 | 5513 4210 | 41 | 1 | 5611 1081 | 52 | 1 |
| 4201 086 | 7 | 3 | 5014 4962 | 44 | 4 | 5024 1220 | 35 | 5 | 5212 4011 | 43 | 2 | 5513 4220 | 41 | 1 | 5611 1092 | 4 | 7 |
| 4201 087 | 7 | 3 | 5014 5132 | 13 | 5 | 5024 1222 | 35 | 6 | 5212 4021 | 18 | 1 | 5513 4230 | 41 | 4 | 5611 1611 | 52 | 2 |
| 4201 088 | 7 | 3 | 5014 5142 | 13 | 4 | 5024 1230 | 35 | 5 | 5212 4021 | 43 | 2 | 5513 4240 | 41 | 4 | 5611 1612 | 52 | 2 |
| 4201 806 | 35 | 10 | 5014 5162 | 13 | 5 | 5024 1232 | 35 | 6 | 5212 4061 | 18 | 1 | 5513 5010 | 30 | 2 | 5611 1613 | 52 | 2 |
| 4201 807 | 35 | 10 | 5014 5172 | 13 | 5 | 5024 1240 | 35 | 5 | 5213 5010 | 19 | 4 | 5513 5110 | 30 | 1 | 5611 1801 | 52 | 5 |
| 4201 808 | 35 | 10 | 5014 5342 | 13 | 4 | 5024 1242 | 35 | 6 | 5213 5110 | 19 | 4 | 5513 5150 | 31 | 5 | 5611 1802 | 52 | 5 |
| 4201 810 | 35 | 11 | 5014 5562 | 12 | 2 | 5024 6040 | 35 | 7 | 5321 1711 | 52 | 8 | 5513 5170 | 31 | 6 | 5611 1803 | 52 | 5 |
| 4201 811 | 35 | 11 | 5014 5582 | 12 | 2 | 5024 6042 | 35 | 8 | 5321 1711 | 4 | 10 | 5513 5210 | 31 | 3 | 5611 2511 | 4 | 4 |
| 4201 812 | 35 | 11 | 5014 5602 | 12 | 2 | 5024 6050 | 35 | 7 | 5321 1712 | 52 | 8 | 5513 5220 | 30 | 4 | 5611 2512 | 4 | 4 |
| 4201 815 | 35 | 9 | 5014 6012 | 12 | 5 | 5024 6052 | 35 | 8 | 5321 1712 | 4 | 10 | 5513 5230 | 30 | 5 | 5611 2611 | 4 | 5 |

| Kod No | Sayfa | Sıra | Kod No | Sayfa | Sıra | Kod No | Sayfa | Sıra | Kod No | Sayfa | Sıra | Kod No | Sayfa | Sıra | Kod No | Sayfa | Sıra |
|------------------|-------|------|------------------|-------|------|-----------|-------|------|------------------|-------|------|-----------|-------|------|------------------|-------|------|
| 5611 2701 | 52 | 3 | 5614 1211 | 49 | 2 | 5615 6364 | 36 | 3 | 5615 9601 | 16 | 4 | 5616 3621 | 47 | 3 | 5616 6621 | 10 | 1 |
| 5611 2701 | 4 | 6 | 5614 1231 | 49 | 2 | 5615 6371 | 36 | 2 | 5615 9611 | 16 | 4 | 5616 3631 | 47 | 3 | 5616 6631 | 10 | 4 |
| 5611 2801 | 4 | 3 | 5614 1501 | 37 | 3 | 5615 6374 | 36 | 3 | 5615 9621 | 16 | 4 | 5616 3641 | 47 | 3 | 5616 6641 | 10 | 1 |
| 5611 2802 | 4 | 3 | 5614 1531 | 37 | 3 | 5615 6387 | 36 | 2 | 5615 9890 | 6 | 1 | 5616 3651 | 47 | 3 | 5616 6671 | 10 | 4 |
| 5611 2981 | 79 | 3 | 5614 1671 | 37 | 3 | 5615 6389 | 36 | 3 | 5615 9960 | 7 | 1 | 5616 3671 | 49 | 4 | 5616 6711 | 10 | 4 |
| 5611 3510 | 4 | 8 | 5614 2113 | 37 | 1 | 5615 6461 | 44 | 1 | 5615 9990 | 7 | 2 | 5616 3681 | 49 | 4 | 5616 7111 | 23 | 1 |
| 5611 3810 | 4 | 2 | 5614 2133 | 37 | 1 | 5615 6471 | 44 | 1 | 5616 1441 | 21 | 1 | 5616 3791 | 49 | 4 | 5616 7121 | 23 | 1 |
| 5611 3811 | 4 | 2 | 5614 2153 | 37 | 1 | 5615 6481 | 44 | 1 | 5616 1451 | 21 | 1 | 5616 3841 | 54 | 5 | 5616 7131 | 23 | 1 |
| 5611 3812 | 4 | 2 | 5614 2163 | 37 | 1 | 5615 6491 | 44 | 1 | 5616 1453 | 21 | 3 | 5616 3861 | 54 | 5 | 5616 7141 | 23 | 3 |
| 5611 4201 | 4 | 1 | 5614 2213 | 37 | 2 | 5615 6521 | 18 | 3 | 5616 1454 | 21 | 3 | 5616 3871 | 54 | 5 | 5616 7151 | 23 | 3 |
| 5611 4202 | 4 | 1 | 5614 2233 | 37 | 2 | 5615 6731 | 49 | 3 | 5616 1455 | 21 | 3 | 5616 3872 | 54 | 5 | 5616 7161 | 23 | 3 |
| 5612 1062 | 52 | 1 | 5614 2253 | 37 | 2 | 5615 6732 | 49 | 3 | 5616 1461 | 21 | 2 | 5616 3961 | 49 | 5 | 5616 7171 | 23 | 5 |
| 5612 2511 | 35 | 3 | 5614 2263 | 37 | 2 | 5615 6733 | 49 | 3 | 5616 1471 | 21 | 2 | 5616 3972 | 49 | 6 | 5616 7181 | 23 | 5 |
| 5612 2521 | 35 | 3 | 5615 1050 | 9 | 7 | 5615 6781 | 54 | 4 | 5616 1473 | 21 | 4 | 5616 3981 | 49 | 6 | 5616 7191 | 23 | 5 |
| 5612 2812 | 35 | 4 | 5615 1060 | 9 | 8 | 5615 6782 | 54 | 4 | 5616 1474 | 21 | 4 | 5616 4011 | 47 | 1 | 5616 7211 | 23 | 2 |
| 5612 2822 | 35 | 4 | 5615 2031 | 38 | 6 | 5615 6783 | 54 | 4 | 5616 1475 | 21 | 4 | 5616 4021 | 47 | 1 | 5616 7221 | 23 | 2 |
| 5612 2832 | 35 | 4 | 5615 2901 | 8 | 1 | 5615 6801 | 54 | 6 | 5616 1651 | 24 | 4 | 5616 4031 | 47 | 1 | 5616 7231 | 23 | 2 |
| 5612 2842 | 35 | 4 | 5615 2921 | 8 | 1 | 5615 6824 | 61 | 2 | 5616 1661 | 24 | 5 | 5616 4041 | 47 | 1 | 5616 7241 | 23 | 4 |
| 5612 2852 | 35 | 4 | 5615 2931 | 8 | 1 | 5615 7851 | 69 | 2 | 5616 1671 | 24 | 6 | 5616 4051 | 47 | 1 | 5616 7251 | 23 | 4 |
| 5612 2862 | 35 | 4 | 5615 2951 | 8 | 1 | 5615 8001 | 13 | 2 | 5616 1901 | 24 | 2 | 5616 4071 | 46 | 1 | 5616 7261 | 23 | 4 |
| 5612 2872 | 35 | 4 | 5615 2971 | 8 | 1 | 5615 8160 | 6 | 1 | 5616 1921 | 24 | 1 | 5616 4081 | 46 | 1 | 5616 7271 | 23 | 6 |
| 5612 2882 | 35 | 4 | 5615 3011 | 9 | 1 | 5615 8170 | 6 | 1 | 5616 1941 | 24 | 3 | 5616 4091 | 46 | 1 | 5616 7281 | 23 | 6 |
| 5612 6111 | 33 | 1 | 5615 3021 | 9 | 2 | 5615 8180 | 6 | 6 | 5616 1961 | 24 | 3 | 5616 4251 | 47 | 2 | 5616 7291 | 23 | 6 |
| 5612 6121 | 33 | 2 | 5615 3111 | 11 | 1 | 5615 8190 | 6 | 5 | 5616 1971 | 24 | 1 | 5616 4261 | 47 | 2 | 5616 7511 | 22 | 1 |
| 5612 6151 | 33 | 1 | 5615 3131 | 11 | 1 | 5615 8200 | 6 | 3 | 5616 1981 | 24 | 2 | 5616 4271 | 47 | 2 | 5616 7521 | 22 | 1 |
| 5612 6161 | 33 | 1 | 5615 3141 | 11 | 3 | 5615 8310 | 6 | 2 | 5616 1991 | 20 | 1 | 5616 4281 | 47 | 2 | 5616 7531 | 22 | 1 |
| 5612 6171 | 33 | 2 | 5615 3151 | 11 | 3 | 5615 8380 | 6 | 2 | 5616 2001 | 20 | 1 | 5616 4291 | 47 | 2 | 5616 7541 | 22 | 1 |
| 5612 6181 | 33 | 2 | 5615 3171 | 11 | 3 | 5615 8390 | 6 | 2 | 5616 2011 | 20 | 1 | 5616 4341 | 46 | 2 | 5616 7551 | 22 | 1 |
| 5613 1010 | 5 | 1 | 5615 3191 | 11 | 3 | 5615 8450 | 6 | 4 | 5616 2021 | 20 | 2 | 5616 4421 | 45 | 1 | 5616 7561 | 22 | 1 |
| 5613 1011 | 27 | 9 | 5615 3211 | 42 | 1 | 5615 8460 | 6 | 4 | 5616 2031 | 20 | 2 | 5616 4431 | 45 | 1 | 5616 7571 | 22 | 1 |
| 5613 1101 | 27 | 10 | 5615 3311 | 45 | 3 | 5615 8470 | 6 | 6 | 5616 2041 | 20 | 2 | 5616 4441 | 45 | 1 | 5616 7581 | 22 | 1 |
| 5613 1131 | 27 | 3 | 5615 3511 | 36 | 1 | 5615 8480 | 6 | 5 | 5616 2051 | 20 | 3 | 5616 4741 | 18 | 1 | 5616 7591 | 22 | 1 |
| 5613 1161 | 27 | 6 | 5615 3514 | 36 | 1 | 5615 8490 | 6 | 3 | 5616 2061 | 20 | 3 | 5616 4741 | 43 | 1 | 5616 7611 | 22 | 2 |
| 5613 1321 | 27 | 5 | 5615 3521 | 36 | 1 | 5615 8540 | 13 | 8 | 5616 2071 | 20 | 4 | 5616 4751 | 18 | 1 | 5616 7621 | 22 | 2 |
| 5613 1331 | 27 | 2 | 5615 3531 | 36 | 4 | 5615 8550 | 13 | 8 | 5616 2081 | 20 | 4 | 5616 4751 | 43 | 1 | 5616 7631 | 22 | 2 |
| 5613 1341 | 27 | 1 | 5615 3534 | 36 | 4 | 5615 8641 | 11 | 2 | 5616 2091 | 20 | 4 | 5616 4791 | 18 | 1 | 5616 7641 | 22 | 2 |
| 5613 1371 | 27 | 4 | 5615 3561 | 36 | 1 | 5615 8650 | 11 | 4 | 5616 2101 | 20 | 3 | 5616 5410 | 5 | 12 | 5616 7651 | 22 | 2 |
| 5613 1381 | 27 | 2 | 5615 4001 | 3 | 12 | 5615 8660 | 11 | 4 | 5616 2121 | 20 | 5 | 5616 5411 | 61 | 3 | 5616 7661 | 22 | 2 |
| 5613 1391 | 27 | 1 | 5615 4021 | 70 | 7 | 5615 8670 | 11 | 2 | 5616 2131 | 20 | 5 | 5616 5611 | 55 | 3 | 5616 7671 | 22 | 2 |
| 5613 1431 | 26 | 3 | 5615 4101 | 3 | 7 | 5615 8680 | 11 | 4 | 5616 2141 | 20 | 5 | 5616 5621 | 55 | 3 | 5616 7681 | 22 | 2 |
| 5613 1441 | 26 | 3 | 5615 4711 | 64 | 2 | 5615 8750 | 9 | 3 | 5616 2151 | 20 | 6 | 5616 5651 | 58 | 1 | 5616 7691 | 22 | 2 |
| 5613 1481 | 26 | 1 | 5615 4721 | 68 | 2 | 5615 8760 | 9 | 5 | 5616 2161 | 20 | 6 | 5616 5661 | 58 | 1 | 5616 8011 | 22 | 4 |
| 5613 1491 | 26 | 1 | 5615 4731 | 63 | 3 | 5615 8770 | 9 | 1 | 5616 2171 | 20 | 6 | 5616 5671 | 58 | 2 | 5616 8021 | 22 | 4 |
| 5613 1531 | 26 | 4 | 5615 4761 | 64 | 1 | 5615 8780 | 9 | 6 | 5616 2231 | 20 | 6 | 5616 5681 | 58 | 2 | 5616 8031 | 22 | 4 |
| 5613 1541 | 26 | 4 | 5615 5051 | 24 | 7 | 5615 8811 | 13 | 1 | 5616 2251 | 20 | 7 | 5616 5721 | 55 | 1 | 5616 8041 | 22 | 4 |
| 5613 1581 | 26 | 2 | 5615 5741 | 54 | 3 | 5615 8870 | 9 | 2 | 5616 2261 | 20 | 7 | 5616 5741 | 55 | 2 | 5616 8051 | 22 | 4 |
| 5613 1591 | 26 | 2 | 5615 5811 | 54 | 2 | 5615 8880 | 9 | 4 | 5616 2271 | 20 | 7 | 5616 5751 | 55 | 2 | 5616 8061 | 22 | 4 |
| 5613 4660 | 4 | 11 | 5615 5851 | 54 | 1 | 5615 9141 | 14 | 4 | 5616 2401 | 24 | 8 | 5616 5791 | 55 | 1 | 5616 8141 | 22 | 3 |
| 5614 0211 | 5 | 1 | 5615 5861 | 54 | 1 | 5615 9201 | 14 | 3 | 5616 2451 | 2 | 8 | 5616 6021 | 10 | 9 | 5616 8151 | 22 | 3 |
| 5614 0211 | 5 | 1 | 5615 5871 | 54 | 1 | 5615 9231 | 14 | 1 | 5616 2621 | 2 | 12 | 5616 6051 | 10 | 7 | 5616 8161 | 22 | 3 |
| 5614 0611 | 5 | 2 | 5615 6121 | 15 | 3 | 5615 9271 | 14 | 2 | 5616 2810 | 45 | 2 | 5616 6071 | 10 | 7 | 5616 8171 | 22 | 3 |
| 5614 0810 | 5 | 3 | 5615 6131 | 15 | 3 | 5615 9291 | 15 | 1 | 5616 2820 | 45 | 2 | 5616 6091 | 10 | 8 | 5616 8181 | 22 | 3 |
| 5614 1011 | 53 | 1 | 5615 6141 | 15 | 3 | 5615 9301 | 16 | 1 | 5616 2830 | 45 | 2 | 5616 6101 | 10 | 10 | 5616 8191 | 22 | 3 |
| 5614 1021 | 53 | 2 | 5615 6171 | 15 | 2 | 5615 9311 | 16 | 1 | 5616 2911 | 2 | 11 | 5616 6111 | 10 | 8 | 5617 1051 | 50 | 4 |
| 5614 1031 | 53 | 3 | 5615 6181 | 15 | 2 | 5615 9321 | 16 | 1 | 5616 2921 | 2 | 11 | 5616 6131 | 10 | 6 | 5617 1071 | 50 | 3 |
| 5614 1041 | 53 | 1 | 5615 6191 | 15 | 2 | 5615 9331 | 16 | 1 | 5616 2951 | 2 | 11 | 5616 6141 | 10 | 9 | 5617 1081 | 50 | 2 |
| 5614 1051 | 53 | 2 | 5615 6211 | 4 | 7 | 5615 9341 | 15 | 1 | 5616 3220 | 5 | 4 | 5616 6151 | 10 | 6 | 5617 1091 | 50 | 1 |
| 5614 1061 | 53 | 3 | 5615 6241 | 44 | 2 | 5615 9391 | 15 | 1 | 5616 3230 | 5 | 4 | 5616 6181 | 10 | 9 | 5617 1110 | 50 | 6 |
| 5614 1071 | 53 | 1 | 5615 6242 | 44 | 3 | 5615 9411 | 16 | 3 | 5616 3310 | 69 | 1 | 5616 6221 | 10 | 9 | 5617 1371 | 51 | 4 |
| 5614 1081 | 53 | 2 | 5615 6251 | 44 | 2 | 5615 9421 | 16 | 3 | 5616 3320 | 69 | 3 | 5616 6511 | 10 | 4 | 5617 1372 | 51 | 4 |
| 5614 1091 | 53 | 3 | 5615 6252 | 44 | 3 | 5615 9431 | 16 | 3 | 5616 3340 | 69 | 1 | 5616 6541 | 10 | 2 | 5617 1381 | 51 | 3 |
| 5614 1121 | 53 | 4 | 5615 6261 | 44 | 2 | 5615 9491 | 16 | 2 | 5616 3350 | 69 | 3 | 5616 6561 | 10 | 2 | 5617 1391 | 51 | 2 |
| 5614 1151 | 53 | 1 | 5615 6262 | 44 | 3 | 5615 9501 | 16 | 2 | 5616 3571 | 48 | 5 | 5616 6581 | 10 | 3 | 5617 1401 | 51 | 2 |
| 5614 1161 | 53 | 2 | 5615 6281 | 44 | 2 | 5615 9511 | 16 | 2 | 5616 3581 | 48 | 6 | 5616 6591 | 10 | 5 | 5617 1411 | 51 | 1 |
| 5614 1171 | 53 | 3 | 5615 6361 | 36 | 2 | 5615 9521 | 16 | 2 | 5616 3611 | 47 | 3 | 5616 6601 | 10 | 3 | | | |

| Kod No | Sayfa | Sıra | Kod No | Sayfa | Sıra | Kod No | Sayfa | Sıra | Kod No | Sayfa | Sıra | Kod No | Sayfa | Sıra | Kod No | Sayfa | Sıra |
|------------------|-------|------|------------------|-------|------|------------------|-------|------|------------------|-------|------|------------------|-------|------|------------------|-------|------|
| 5617 1621 | 50 | 5 | 5715 3060 | 66 | 3 | 5732 4020 | 5 | 7 | 5913 1460 | 36 | 5 | 5981 1320 | 75 | 8 | 5985 1060 | 77 | 2 |
| 5617 1631 | 50 | 5 | 5716 1110 | 66 | 1 | 5732 4070 | 5 | 7 | 5913 1460 | 36 | 6 | 5981 2530 | 72 | 5 | 5985 1070 | 77 | 2 |
| 5617 1701 | 48 | 1 | 5718 1250 | 68 | 4 | 5732 4220 | 5 | 8 | 5913 1460 | 74 | 2 | 5981 2540 | 72 | 5 | 5985 1080 | 77 | 2 |
| 5617 1711 | 48 | 1 | 5718 1310 | 67 | 2 | 5732 5010 | 3 | 3 | 5913 1460 | 79 | 8 | 5981 2650 | 72 | 1 | 5985 2510 | 76 | 2 |
| 5617 1721 | 48 | 4 | 5718 1310 | 68 | 6 | 5732 5020 | 3 | 3 | 5913 1470 | 6 | 7 | 5981 2660 | 72 | 1 | 5985 2520 | 76 | 2 |
| 5617 1731 | 48 | 3 | 5718 1330 | 68 | 5 | 5732 5070 | 3 | 3 | 5913 1470 | 9 | 8 | 5981 2680 | 72 | 2 | 5985 2530 | 76 | 2 |
| 5617 1752 | 48 | 2 | 5718 1430 | 67 | 3 | 5732 5110 | 69 | 7 | 5913 1470 | 10 | 11 | 5981 2690 | 72 | 2 | 5985 2540 | 76 | 2 |
| 5617 1762 | 48 | 2 | 5718 1430 | 68 | 2 | 5732 7010 | 70 | 8 | 5913 1470 | 11 | 5 | 5981 2710 | 75 | 6 | 5985 2550 | 76 | 2 |
| 5617 1772 | 48 | 2 | 5718 1580 | 68 | 4 | 5732 7020 | 70 | 8 | 5913 1470 | 20 | 8 | 5981 2720 | 75 | 6 | 5985 2560 | 76 | 2 |
| 5617 1831 | 48 | 4 | 5718 1710 | 68 | 1 | 5732 7030 | 70 | 7 | 5913 1470 | 22 | 5 | 5981 2790 | 72 | 2 | 5985 2570 | 76 | 2 |
| 5617 1841 | 48 | 4 | 5718 1720 | 66 | 1 | 5732 7090 | 70 | 8 | 5913 1470 | 23 | 7 | 5981 2840 | 74 | 5 | 5985 2580 | 76 | 2 |
| 5617 1881 | 48 | 3 | 5718 1720 | 68 | 5 | 5732 8430 | 1 | 5 | 5913 1470 | 79 | 8 | 5981 2860 | 74 | 3 | 5985 3210 | 76 | 1 |
| 5617 1891 | 48 | 3 | 5718 1730 | 68 | 1 | 5732 9020 | 5 | 9 | 5913 1580 | 79 | 7 | 5981 2870 | 74 | 4 | 5985 3220 | 76 | 1 |
| 5617 2131 | 49 | 1 | 5718 1850 | 67 | 1 | 5732 9070 | 5 | 9 | 5913 1590 | 79 | 7 | 5981 2880 | 74 | 4 | 5985 3230 | 76 | 1 |
| 5617 2151 | 49 | 1 | 5719 1110 | 67 | 3 | 5732 9120 | 3 | 6 | 5917 1010 | 79 | 6 | 5981 2920 | 75 | 7 | 5985 3240 | 76 | 1 |
| 5618 1114 | 78 | 1 | 5723 0810 | 60 | 3 | 5732 9220 | 3 | 4 | 5917 1020 | 79 | 6 | 5981 3010 | 74 | 6 | 5985 3250 | 76 | 1 |
| 5618 1124 | 78 | 2 | 5723 1011 | 60 | 3 | 5732 9320 | 3 | 4 | 5917 1030 | 79 | 6 | 5981 4010 | 72 | 3 | 5985 3260 | 76 | 1 |
| 5618 1314 | 78 | 1 | 5730 1610 | 65 | 4 | 5740 1031 | 61 | 2 | 5917 1040 | 79 | 6 | 5981 4050 | 72 | 4 | 5985 3270 | 76 | 1 |
| 5618 1324 | 78 | 2 | 5730 1620 | 65 | 4 | 5740 1321 | 61 | 4 | 5917 1620 | 79 | 6 | 5982 2020 | 73 | 2 | 5985 4010 | 77 | 1 |
| 5618 2114 | 78 | 1 | 5730 1730 | 65 | 3 | 5740 1330 | 61 | 4 | 5918 1610 | 80 | 7 | 5982 2030 | 73 | 2 | 5985 4020 | 77 | 1 |
| 5618 2124 | 78 | 2 | 5730 1740 | 65 | 3 | 5812 5110 | 1 | 7 | 5918 1710 | 80 | 7 | 5982 2040 | 73 | 1 | 5985 4030 | 77 | 1 |
| 5618 2314 | 78 | 1 | 5730 2660 | 5 | 5 | 5812 5210 | 1 | 8 | 5918 1720 | 80 | 8 | 5982 2050 | 73 | 3 | 5985 4040 | 77 | 1 |
| 5618 2324 | 78 | 2 | 5730 3410 | 3 | 2 | 5812 5410 | 1 | 9 | 5918 1730 | 80 | 8 | 5982 2060 | 73 | 1 | 5985 4050 | 77 | 1 |
| 5618 3114 | 78 | 1 | 5730 3420 | 69 | 6 | 5812 6110 | 1 | 10 | 5918 1847 | 20 | 8 | 5982 2070 | 73 | 6 | 5985 4060 | 77 | 1 |
| 5618 3124 | 78 | 2 | 5730 4610 | 69 | 9 | 5812 6210 | 1 | 11 | 5918 1848 | 20 | 8 | 5982 2080 | 73 | 4 | 5985 4070 | 77 | 1 |
| 5618 3314 | 78 | 1 | 5730 4620 | 69 | 9 | 5812 6310 | 1 | 12 | 5918 1849 | 20 | 8 | 5982 2090 | 73 | 5 | 5985 4080 | 77 | 1 |
| 5618 3324 | 78 | 2 | 5730 4630 | 5 | 6 | 5812 6710 | 28 | 5 | 5918 2411 | 76 | 3 | 5982 2120 | 73 | 3 | 5985 4090 | 77 | 1 |
| 5711 1180 | 66 | 1 | 5730 4640 | 5 | 6 | 5816 1000 | 2 | 5 | 5918 2421 | 76 | 3 | 5982 2130 | 73 | 1 | 5985 4110 | 77 | 1 |
| 5711 1670 | 65 | 2 | 5730 4660 | 5 | 5 | 5816 1210 | 2 | 6 | 5918 2431 | 76 | 3 | 5982 2140 | 73 | 1 | 5985 4120 | 77 | 1 |
| 5711 1790 | 66 | 2 | 5730 4670 | 68 | 3 | 5816 1420 | 2 | 4 | 5918 2441 | 76 | 3 | 5983 1410 | 72 | 6 | 5985 4130 | 77 | 1 |
| 5711 2300 | 67 | 1 | 5730 4670 | 69 | 8 | 5816 3110 | 2 | 9 | 5918 2451 | 76 | 3 | 5983 1420 | 72 | 6 | 5985 5180 | 74 | 1 |
| 5711 2500 | 67 | 3 | 5730 4680 | 68 | 3 | 5816 3530 | 2 | 10 | 5918 2461 | 76 | 3 | 5983 1430 | 72 | 6 | 5985 5190 | 74 | 1 |
| 5711 2510 | 67 | 2 | 5730 4680 | 69 | 8 | 5816 5120 | 25 | 4 | 5918 2470 | 76 | 4 | 5983 2270 | 6 | 7 | 5985 5210 | 74 | 1 |
| 5711 2632 | 61 | 1 | 5730 5130 | 28 | 3 | 5816 5140 | 25 | 4 | 5918 2480 | 76 | 4 | 5983 2280 | 6 | 7 | 5985 5220 | 74 | 1 |
| 5711 3021 | 61 | 1 | 5730 5180 | 28 | 4 | 5816 5220 | 25 | 3 | 5918 2611 | 78 | 3 | 5984 2210 | 6 | 1 | 5985 5250 | 74 | 2 |
| 5711 3051 | 61 | 1 | 5730 5280 | 1 | 6 | 5816 5240 | 25 | 3 | 5918 2620 | 78 | 3 | 5984 2700 | 6 | 1 | 5985 5260 | 74 | 2 |
| 5711 3061 | 60 | 1 | 5730 5510 | 28 | 6 | 5816 5310 | 24 | 10 | 5918 2630 | 78 | 3 | 5984 2710 | 6 | 2 | 5985 5290 | 74 | 2 |
| 5711 3081 | 60 | 2 | 5730 5550 | 1 | 3 | 5816 5320 | 24 | 11 | 5918 2640 | 78 | 3 | 5984 2750 | 6 | 1 | 5985 5710 | 6 | 8 |
| 5711 3091 | 60 | 2 | 5730 5600 | 1 | 1 | 5816 5330 | 24 | 12 | 5918 2650 | 78 | 4 | 5984 2760 | 6 | 2 | 5985 5730 | 6 | 8 |
| 5711 3101 | 60 | 2 | 5730 5750 | 1 | 2 | 5816 5410 | 25 | 1 | 5918 2660 | 78 | 4 | 5984 2810 | 6 | 2 | 5985 5740 | 9 | 8 |
| 5712 1220 | 67 | 3 | 5730 6050 | 28 | 1 | 5816 5420 | 25 | 1 | 5921 1711 | 81 | 1 | 5984 3280 | 6 | 3 | 5985 9340 | 70 | 9 |
| 5712 1340 | 67 | 2 | 5730 6120 | 28 | 2 | 5816 5450 | 25 | 2 | 5921 1721 | 81 | 1 | 5984 3430 | 6 | 1 | 5985 9360 | 70 | 9 |
| 5712 1410 | 69 | 4 | 5730 7530 | 68 | 3 | 5816 5460 | 25 | 2 | 5921 1731 | 81 | 1 | 5984 3520 | 6 | 2 | 5985 9810 | 60 | 3 |
| 5712 1440 | 69 | 5 | 5730 8540 | 5 | 6 | 5816 5750 | 24 | 9 | 5921 1741 | 81 | 1 | 5984 3540 | 6 | 1 | 5999 5071 | 52 | 8 |
| 5714 1200 | 65 | 2 | 5730 9010 | 70 | 5 | 5911 3001 | 79 | 5 | 5921 1751 | 81 | 2 | 5984 3640 | 6 | 3 | 5999 5071 | 4 | 10 |
| 5714 1210 | 65 | 2 | 5730 9020 | 3 | 5 | 5911 3061 | 79 | 5 | 5921 1761 | 81 | 2 | 5984 5010 | 75 | 1 | 5999 5080 | 2 | 7 |
| 5714 1311 | 63 | 1 | 5730 9030 | 70 | 4 | 5911 3071 | 79 | 5 | 5921 1771 | 81 | 2 | 5984 5020 | 75 | 1 | | | |
| 5714 1321 | 63 | 2 | 5730 9040 | 70 | 3 | 5911 3091 | 79 | 5 | 5921 1781 | 81 | 2 | 5984 5030 | 75 | 1 | | | |
| 5714 1351 | 63 | 4 | 5730 9060 | 70 | 1 | 5912 1071 | 79 | 2 | 5951 6260 | 34 | 2 | 5984 5040 | 75 | 1 | | | |
| 5714 1371 | 62 | 1 | 5730 9080 | 70 | 2 | 5912 1081 | 79 | 2 | 5951 6260 | 42 | 6 | 5984 5050 | 75 | 2 | | | |
| 5714 1381 | 62 | 1 | 5730 9090 | 3 | 1 | 5912 1101 | 79 | 2 | 5951 6270 | 34 | 2 | 5984 5060 | 75 | 2 | | | |
| 5714 1391 | 62 | 2 | 5730 9210 | 3 | 7 | 5912 1111 | 79 | 2 | 5951 6270 | 42 | 6 | 5984 5070 | 75 | 2 | | | |
| 5714 1401 | 62 | 3 | 5730 9240 | 3 | 8 | 5912 1121 | 79 | 2 | 5951 6280 | 34 | 2 | 5984 6010 | 75 | 5 | | | |
| 5714 1411 | 62 | 3 | 5730 9250 | 3 | 9 | 5912 1131 | 79 | 2 | 5951 6280 | 42 | 6 | 5984 6020 | 75 | 4 | | | |
| 5714 1420 | 66 | 2 | 5731 5110 | 5 | 11 | 5912 1141 | 79 | 2 | 5980 1120 | 6 | 6 | 5984 6070 | 75 | 3 | | | |
| 5714 1501 | 59 | 1 | 5731 5310 | 5 | 10 | 5912 1161 | 79 | 2 | 5980 1220 | 6 | 6 | 5984 6080 | 75 | 4 | | | |
| 5714 1521 | 59 | 1 | 5732 1020 | 71 | 4 | 5912 1181 | 79 | 1 | 5980 1420 | 6 | 6 | 5984 6110 | 75 | 5 | | | |
| 5714 1541 | 59 | 1 | 5732 1670 | 71 | 3 | 5912 1211 | 79 | 1 | 5980 1430 | 6 | 6 | 5984 6510 | 75 | 5 | | | |
| 5714 1561 | 59 | 1 | 5732 1670 | 3 | 10 | 5912 1221 | 79 | 1 | 5980 1530 | 6 | 6 | 5984 6520 | 75 | 5 | | | |
| 5715 1060 | 66 | 3 | 5732 1690 | 70 | 6 | 5912 1231 | 79 | 1 | 5980 1540 | 6 | 6 | 5984 6540 | 75 | 5 | | | |
| 5715 1260 | 65 | 1 | 5732 1820 | 3 | 11 | 5912 1241 | 79 | 1 | 5980 6060 | 6 | 4 | 5984 6550 | 75 | 5 | | | |
| 5715 1290 | 67 | 2 | 5732 2520 | 71 | 5 | 5912 1251 | 79 | 1 | 5980 8420 | 6 | 5 | 5984 6560 | 75 | 3 | | | |
| 5715 1370 | 66 | 3 | 5732 2530 | 71 | 5 | 5912 1261 | 79 | 1 | 5981 1120 | 75 | 7 | 5985 1030 | 77 | 2 | | | |
| 5715 1380 | 67 | 1 | 5732 3020 | 71 | 2 | 5913 1090 | 79 | 7 | 5981 1170 | 75 | 8 | 5985 1040 | 77 | 2 | | | |
| 5715 1390 | 67 | 1 | 5732 3120 | 71 | 1 | 5913 1120 | 79 | 7 | 5981 1310 | 75 | 8 | 5985 1050 | 77 | 2 | | | |

ATEX Belgesi

IEP ENERGY PETROLEUM INSTITUTE

IEP ATEX

(1) **EU- Internal Production Control Certificate**

(2) **Equipment or Protective Systems Intended for Use in Potentially Explosive Atmospheres**
Directive 2014/34/EU

(3) EU – Internal Production Control Certificate Number: **IEP 16 ATEX 0468**

(4) Product: **Led lighting fixtures, Pelsan xy series**

(5) Firm Name: **PELSAN AYDINLATMA SANAYİ VE TİCARET A.Ş.**

(6) Firm Address: **İmes Sanayi Sitesi A Blok 101 Sokak, No:38 Dudullu Ümraniye - İSTANBUL - TURKEY**

(7) This product any of acceptable variation thereto is specified in the schedule to this certificate and the documents therein referred to.

(8) The IEP Uluslararası Enerji Petrol Gazıtım - Sertifikasyon ve Teknik Hizmetler Organizasyonu Tic. Ltd. Şti., notified body number 2284 in accordance with Article 17 of the Directive 2014/34/EU of European Parliament and of the Council, dated 26 February 2014, certifies that this product has been found to comply with the Essential Health and Safety Requirements relating to the design and construction of products intended for use in potentially explosive atmospheres, given in Annex II/VIII to the Directive. The examination and test results are recorded in confidential Report Nr: IEP.Rp.Ex.10-1037 date 18.11.2016.

(9) Compliance with Essential Health and safety requirements has been assured by compliance with:
EN 60079-0 ; 2012, EN 60079-15 ; 2010, EN 60079-31 ; 2009

(10) If the sign " X " is placed after the certificate number, it indicates that the product is subject to Specified Conditions of Safe Use specified in the schedule to this certificate.

(11) This EU-Internal Production Control Certificate relates only to the design and construction of the specified product in accordance to the directive 2014/34/EU. Further requirements of the directive apply to the manufacturing process and supply of this product. These are not covered by this certificate. Validity date: 10 year. If standard or product change, this certificate is invalid.

(12) The marking of the equipment or protective system shall include the following:

II 3G Ex nR IIC T5 Gc
II 3D Ex tc IIIC (T 95 °C) Dc

Responsible Person :
Nasrettin Terzioğlu
Head of Certification Body

Date of Issue : **22.11.2016**

IEP Uluslararası Enerji Petrol Gazıtım - Sertifikasyon ve Teknik Hizmetler Organizasyonu Tic. Ltd. Şti.
37461 Sok. No:9 K:2 Beşiktaş - İZMİR - TÜRKİYE
Tel: +90 232 431 17 43 - 46 Fax: +90 232 431 17 39 E-mail: info@iep.com.tr Fr:45
This certificate is granted subject to the general conditions of the IEP Energy Petroleum Institute. This certificate may only be reproduced in its entirety and without any change, schedule included. You can check accuracy of this document by www.iep.com.tr
Page | 1 / 2

IEP ENERGY PETROLEUM INSTITUTE

(13) Schedule

(14) Certificate Nr: **IEP 16 ATEX 0468**

(15) Description of Equipment Protective System:

The Led lighting fixtures, Pelsan xy series designed as an floodlights, high bay and canopy are mounting type of electrical device. Led lighting fixtures, Pelsan xy series made from according to Aluminum. Led lighting fixtures, Pelsan xy series is equipped with cable gland d or e type. To must be used of ground cable 4 mm² (min) and HD 21.13.S1/HD.22.4.34.Led lighting fixtures have been evaluated in the contents of IP 66.Led lighting fixtures use as zone 2 and 22 that be used danger area determined in the EN 60079-10-1 and EN 60079-10-2 standard.

Technical Parameters: Led lighting fixtures, Pelsan xy series

| Type | Power (W) |
|-----------------------|-----------------------|
| Proliz | 50, 75, 100, 125, 150 |
| Sia | 50, 75, 100, 125, 150 |
| Naim | 50, 75, 100, 125, 150 |
| Operating Voltage | 230 V AC , 50 / 60 Hz |
| Operating Temperature | (-20 – +50) °C |

Led lighting fixtures Product Code System

Pelsan X Y
Power (50, 75, 100, 125, 150)
Model; Proliz , Sia, Naim (Accessory)
Mark

(16) This certificate is in the contents of standards that mentioned in item [9] . It has been accepted that Led lighting fixtures is manufactured according to the producer instructions and the standards mentioned above.

(17) Information's of mounting instruction manual of 4 pages approved and date 08.02.2016.

(18) List of Documentation:

| Drawing Nr : | Drawing Name : | Date : |
|--------------|----------------------|------------|
| PLS-01 | Frame | 25.01.2016 |
| PLS-02 | Body Aluminum | 25.01.2016 |
| PLS-03 | Plastic Driver Cover | 25.01.2016 |
| PLS-04 | Screw Cross Section | 25.01.2016 |
| PLS-05 | Exploded Drawing | 25.01.2016 |
| PLS-06 | Assembly | 25.01.2016 |
| PLS-07 | Plastic Reflector | 25.01.2016 |
| PLS-08 | Roof Connection | 25.01.2016 |

Part inside of Led lighting fixtures, Pelsan xy series indicated in the part list and equipment list, table 1 dated 08.02.2016.

Responsible Person :
Nasrettin Terzioğlu
Head of Certification Body

Date of Issue : **22.11.2016**

IEP Uluslararası Enerji Petrol Gazıtım - Sertifikasyon ve Teknik Hizmetler Organizasyonu Tic. Ltd. Şti.
37461 Sok. No:9 K:2 Beşiktaş - İZMİR - TÜRKİYE Tel: +90 232 431 17 43 - 46 Fax: +90 232 431 17 39 E-mail: info@iep.com.tr Fr:45
This certificate is granted subject to the general conditions of the IEP Energy Petroleum Institute. This certificate may only be reproduced in its entirety and without any change, schedule included. You can check accuracy of this document by www.iep.com.tr
Page | 2 / 2

ATEX Belgeli Pelsan Exproof armatürler, tehlikeli gaz ve toz maddelerinin bulunduğu, patlama riski olan ortamlarda güvenle kullanılabilir.

Türk Akreditasyon Sertifikası

TÜRKAK TÜRK AKREDİTASYON KURUMU

AKREDİTASYON SERTİFİKASI

Deney Laboratuvarı olarak faaliyet gösteren,

PELSAN AYDINLATMA SANAYİ VE TİCARET A.Ş.
Pelsan Aydınlatma Laboratuvarı
Emek Mah. Nato Yolu Cad. No:280 Sancaktepe
34785 İSTANBUL / TÜRKİYE

TÜRKAK tarafından yapılan denetim sonucunda TS EN ISO/IEC 17025:2012 Standardına göre Ek'te yer alan kapsamlarda akredite edilmiştir.

Akreditasyon No : **AB-0795-T**
Akreditasyon Tarihi : **28 Nisan 2015**

Bu Sertifika, yukarıda açık adı ve adresi yazılı Kuruluşun TS EN ISO/IEC 17025:2012 Standardına, ilgili Yönetmelik ve Tebliğlere uygunluğunu sürdürmesi halinde, **27 Nisan 2019** tarihine kadar geçerlidir.

Dr. H. İbrahim ÇETİN
Genel Sekreter

TÜRK AKREDİTASYON KURUMU
1999

Page | 1 / 2

Türk Akreditasyon Kurumu tarafından akredite olan laboratuvarımız ile tüm aydınlatma ürünlerini belgeliyoruz.

ENEC Belgeleri



LED Yol ve Cadde Armatürleri



LED Projektörler



Sıva Altı LED Ofis Armatürleri



Sodyum-Metal Halide Lambalar



Sıva Üstü LED Ofis Armatürleri



Elektronik Balast



/PelsanAydinlatma



pelsan-aydinlatma



pelsan aydinlatma



/pelsanaydinlatma



/PelsanLight

www.pelsan.com.tr

info@pelsan.com.tr • export@pelsan.com.tr

GENEL MERKEZ

İmes Sanayi Sitesi
A Blok 101 Sk. No.38
Y. Dudullu / İstanbul

T: (0850) 460 75 76
F: (0216) 364 60 15

FABRİKA

Çerkeşli OSB İmes
5. Cadde No.12
Dilovası / Kocaeli

T: (0850) 460 75 76
F: (0216) 364 60 15

KARAKÖY MERKEZ

Emekyemez Mah.
Yanıkkapı Porsuk Sk.
No.11 Karaköy / İstanbul

T: (0850) 460 75 76
F: (0216) 364 60 15

PERPA BÖLGE OFİSİ

Perpa Ticaret Merkezi
A Blok Kat: 9 No.1178
Okmeydanı / İstanbul

T: (0850) 460 75 76
F: (0216) 364 60 15

Fiyatlara KDV dahil değildir. Pelsan Aydınlatma gerekli koşullarda fiyat ve ürün değiştirme hakkını saklı tutar.



İÇ MEKAN



DIŞ MEKAN



ENDÜSTRİYEL



LAMBALAR



KOMPONENTLER