



# BATHROOM LIGHTS



# CONTENT

## BATHROOM LIGHTS

**1-11**

DOWNLIGHT 1-4

SPOT LIGHT 5

CEILING LIGHT 6

PIR DOWNLIGHT 7

MIRROR LIGHT 7-11

SHAVER LIGHT 8

MIRROR/WALL LIGHT 9

## APPENDIX

**12-13**

IP RATINGS 12

IP REGULATIONS 13

# INTRODUCTION



**Luen Yick Electrical MFG. CO., LTD.** established in 1968. We are expert in electrical and lighting products. With our sophisticated testing laboratory, under the stringent quality control procedures are carried out, we would surely fulfill your requirement. It is appreciated with our worldwide customers with our 40 years of experience. Our mainland China factory have awarded with BSI certificate (BS EN ISO9001: 2000), we would perform highly commitment to quality. Our products meet CE, GS, Semko & UL Approvals.

Besides, all production processes are done in-house from tooling to finished products. The customers' designs are always welcome and your work with us stays confidential. OEM / ODM orders are welcome.



ISO 9001:2000  
Certificate No.: FM 85977



Tooling Department



CNC Equipment



Plastic Injection Department



Plastic Extrusion Department



Metal Stamping Department



Assembly Lines



Die Casting Department



Photometric, Colorimetric & Electric Parameters Equipment



Glow Wire Tester



Modernizing Warehouse

# BATHROOM Downlights

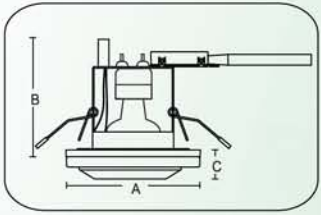

- Voltage: 230V, 12V
- Wattage: Max.50W
- Lamp type: MR16 / GZ10 / GU10
- Construction: Tempered glass, with aluminium die cast ring, zinc alloy die cast body
- IP Rating: IP55

Recessed Mount **SL515**



Recessed Mount **SL515A**

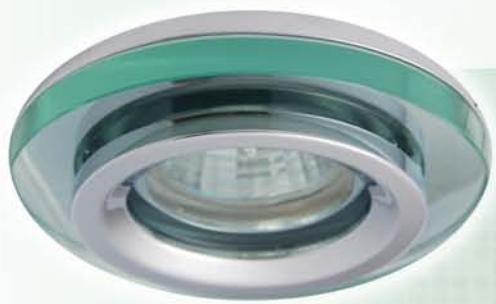

Recessed Mount **SL515B**



Recessed Mount **SL515C**



MODEL	WATT	DIMENSION (mm)	IND. BOX (mm)	OUTER CARTON (mm)	WEIGHT (kg)	
		A x B x C		DIMENSION / PCS.	G.W.	N.W.
SL515	50	104 x 83 x 11	140 x 106 x 134	700 x 325 x 240 / 20	13	11.4
SL515A	50	104 x 83 x 15	140 x 106 x 134	700 x 325 x 240 / 20	13	11.4
SL515B	50	104 x 83 x 15	140 x 106 x 134	700 x 325 x 240 / 20	13	11.4
SL515C	50	104 x 83 x 17	140 x 106 x 134	700 x 325 x 240 / 20	13	11.4

## BATHROOM Mirror light

### MLP213A-PS

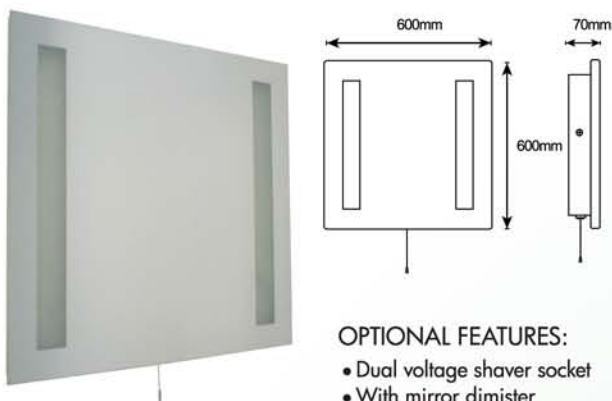

- OPTIONAL FEATURES:
- Dual voltage shaver socket
  - With mirror dimister



VOLTAGE:	230V
WATTAGE:	2 x 13W Max.
LAMP TYPE:	T5 fluorescent tube
CONSTRUCTION:	Metal and mirror
IP RATING:	IP44
IND. BOX:	660 x 120 x 668 mm
CTN SIZE / PCS.:	672 x 132 x 680 mm / 1 pc.
WEIGHT (KG) G.W. / N.W.:	10.4 / 8.9 kg

### MLP113-PS



- OPTIONAL FEATURES:
- Dual voltage shaver socket
  - With mirror dimister



VOLTAGE:	230V
WATTAGE:	13W
LAMP TYPE:	T5 fluorescent tube
CONSTRUCTION:	Metal and mirror
IP RATING:	IP44
IND. BOX:	672 x 110 x 520 mm
CTN SIZE / PCS.:	684 x 122 x 532 mm / 1 pc.
WEIGHT (KG) G.W. / N.W.:	5.9 / 4.5 kg

### MLP610-PS

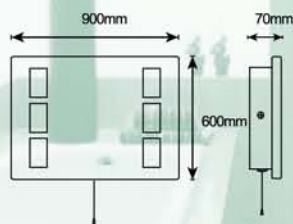

- OPTIONAL FEATURES:
- Dual voltage shaver socket
  - With mirror dimister



VOLTAGE:	230V
WATTAGE:	6 x 10W Max.
LAMP TYPE:	JC Capsule G4
CONSTRUCTION:	Metal and mirror
IP RATING:	IP44
IND. BOX:	968 x 120 x 660 mm
CTN SIZE / PCS.:	980 x 132 x 672 mm / 1 pc.
WEIGHT (KG) G.W. / N.W.:	14.3 / 12.7 kg

# BATHROOM Mirror light

## MLP40R-PS

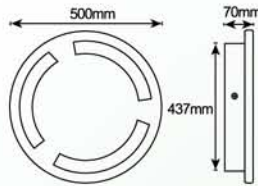

**OPTIONAL FEATURES:**

- Dual voltage shaver socket
- With mirror dimister



VOLTAGE:	230V
WATTAGE:	40W
LAMP TYPE:	FCL
CONSTRUCTION:	Metal and mirror
IP RATING:	IP44
IND. BOX:	563 x 113 x 568 mm
CTN SIZE / PCS.:	575 x 125 x 580 mm / 1 pc.
WEIGHT (KG) G.W. / N.W.:	6.3 / 4.8 kg

## MLP810R-PS

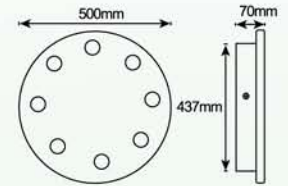
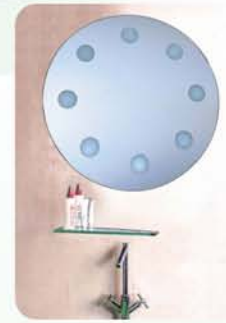

**OPTIONAL FEATURES:**

- Dual voltage shaver socket
- With mirror dimister



VOLTAGE:	12V/ 230V
WATTAGE:	8 x 10W Max.
LAMP TYPE:	JC Capsule G4
CONSTRUCTION:	Metal and mirror
IP RATING:	IP44
IND. BOX:	563 x 113 x 568 mm
CTN SIZE / PCS.:	575 x 125 x 580 mm / 1 pc.
WEIGHT (KG) G.W. / N.W.:	6.3 / 4.8 kg

## MLP215C-PS

**Dual Voltage Shaver Socket**



**OPTIONAL FEATURES:**

- Dual voltage shaver socket
- With mirror dimister

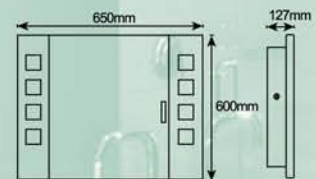

VOLTAGE:	230V
WATTAGE:	2 x 15W
LAMP TYPE:	T8 fluorescent tube
CONSTRUCTION:	Metal and mirror
IP RATING:	IP44
IND. BOX:	683 x 168 x 633 mm
CTN SIZE / PCS.:	695 x 180 x 645 mm / 1 pc.
WEIGHT (KG) G.W. / N.W.:	15.1 / 13 kg

## APPENDIX IP Ratings



Under EN 60529, all light fittings are rated for their protection against ingress by water and dust particles or other foreign objects. The rating is expressed as a two-part IP number - for example IP67. The two numbers correspond to their protection level: the first number (between 1 and 6) refers to the level of protection from ingress by dust and other solid objects; the second number (1 to 8) refers to the level of protection from harmful water ingress. The protection levels are defined in the following tables.

### First Number (protection level against solid objects)

IP	Defined protection Level
IPOX	No Protection
IP1X	Protects against foreign bodies down to 50mm diameter
IP2X	Protects against foreign bodies down to 12.5mm in diameter
IP3X	Protects against foreign bodies down to 2.5mm in diameter
IP4X	Protects against foreign bodies down to 1mm in diameter
❧ IP5X	Protection against harmful dust deposits, ingress of dust is not totally prevented, but dust shall not penetrate in a quantity to interfere with satisfactory operation of the apparatus or to impair safety – Dust protected.
❧ IP6X	Protects against any entry of dust – dust-tight

\*Therefore an IP67 luminaire would be protected against the ingress of dust and the effect of temporary water immersion down 1 metre.

### Second Number (protection level against water)

IP	Defined protection Level
IPX0	No Protection
IPX1	Protects against drop of water falling vertically. Limited ingress permitted.
💧 IPX2	Protects against drop of water falling up to 15° from the vertical. Limited ingress permitted.
☔ IPX3	Protects against drop of water sprayed up to 60 degree on either side of the vertical-rain proof. Spraying – proof.
⚠ IPX4	Protects from water splashed from all directions – splash – proof.
⚠⚠ IPX5	Protects from low-pressure jets of water from all directions – jet – proof .
IPX6	Protects against heavy seas or strong jets of water.
💧💧 IPX7	Protects against temporary immersion down to 1 metre – water-tight. Not for permanent immersion.
💧💧...m IPX8	Protects against permanent immersion at specified water depth – pressure water-tight.

## APPENDIX IP Regulations

### BATHROOMS & OTHERS WET AREAS

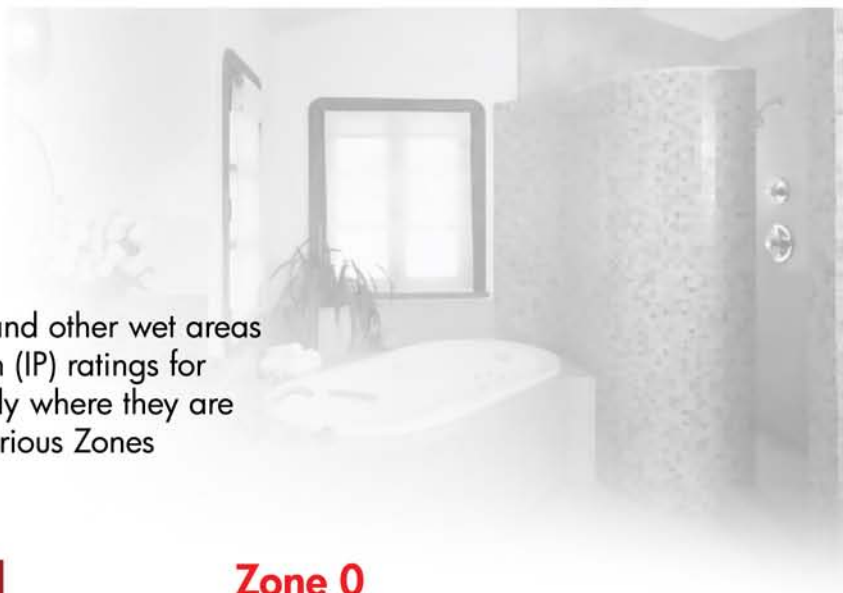

Areas within bathrooms, showers and other wet areas require particular Ingress Protection (IP) ratings for light fittings, depending on precisely where they are located. The drawing shows the various Zones which are covered.

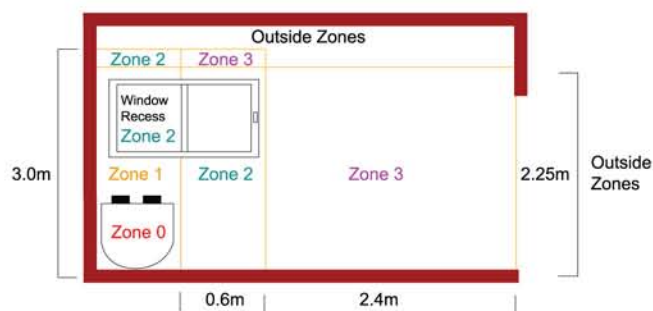

#### Zone 0

This is the area inside the bath or shower – fittings used here should be rated **IPX7**.

#### Zone 1

This refers to the area above the bath or shower up to a height of 2.25 meters – fittings here should have a minimum rating of **IPX4**.



#### Zone 2

This covers an area 0.6 metres wide, immediately next to, and all around zone 1, plus the area above 2.25 metres over the bath or shower. Wash basins should be treated as Zone 2. The minimum rating here is **IPX4**. Where water jets are likely to be used for cleaning purposes in Zones 1 & 2, the rating is minimum **IPX5**.



#### Zone 3

This areas has no special requirements, unless water jets are likely to be used for cleaning purposes, Equipment installed outside zones 0, 1, 2 & 3 must be suitable for the conditions most likely to prevail at that particular point.



## BATHROOM Downlights

**SL514** Recessed Mount

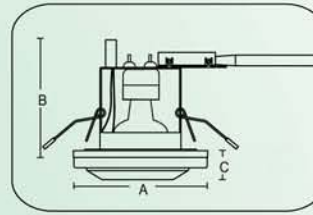

- Voltage: 230V, 12V
- Wattage: Max.50W
- Lamp type: MR16 / GZ10 / GU10
- Construction: Tempered glass, with aluminium die cast ring, zinc alloy die cast body
- IP Rating: IP55

**SL514A** Recessed Mount



**SL514B** Recessed Mount



**SL514C** Recessed Mount



MODEL	WATT	DIMENSION (mm) A x B x C	IND. BOX (mm)	OUTER CARTON (mm) DIMENSION / PCS.	WEIGHT (kg)	
					G.W.	N.W.
SL514	50	104 x 83 x 11	140 x 106 x 134	700 x 325 x 240 / 20	13.7	12.2
SL514A	50	104 x 83 x 15	140 x 106 x 134	700 x 325 x 240 / 20	13.7	12.2
SL514B	50	104 x 83 x 15	140 x 106 x 134	700 x 325 x 240 / 20	13.7	12.2
SL514C	50	104 x 83 x 17	140 x 106 x 134	700 x 325 x 240 / 20	13.7	12.2

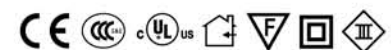

## BATHROOM Downlights

### SL511

Recessed Mount

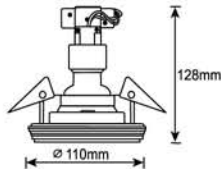

VOLTAGE: 230V, 12V  
 WATTAGE: Max. 50W  
 LAMP TYPE: MR16 / GZ10 / GU10  
 CONSTRUCTION: Aluminium & frosted glass  
 IP RATING: IP55  
 IND. BOX: 115 x 115 x 105 mm  
 CTN SIZE / PCS.: 480 x 250 x 545 mm / 40 pcs.  
 WEIGHT (KG) G.W. / N.W.: 19.2 / 17 kg

• Completed with White, Brass & Chrome trims

### SL512

Recessed Mount

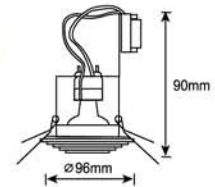

VOLTAGE: 230V, 12V  
 WATTAGE: Max. 50W  
 LAMP TYPE: MR16 / GZ10 / GU10  
 CONSTRUCTION: Aluminium & frosted glass  
 IP RATING: IP44  
 IND. BOX: 100 x 100 x 95 mm  
 CTN SIZE / PCS.: 400 x 220 x 495 mm / 40 pcs.  
 WEIGHT (KG) G.W. / N.W.: 17.6 / 15.2 kg

CASING COLOUR:

WH WHITE BR BRASS CR CHROME SN SATIN NICKEL

### SL513

Recessed Mount

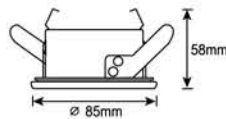

VOLTAGE: 230V, 12V  
 WATTAGE: Max. 50W  
 LAMP TYPE: MR16 / GZ10 / GU10  
 CONSTRUCTION: Aluminium die cast  
 IP RATING: IP55  
 IND. BOX: 90 x 90 x 74 mm  
 CTN SIZE / PCS.: 470 x 200 x 390 mm / 50 pcs.  
 WEIGHT (KG) G.W. / N.W.: 16.6 / 14.5 kg

CASING COLOUR:

WH WHITE BR BRASS CR CHROME SN SATIN NICKEL

### PDL2009

Recessed / Surface Mount

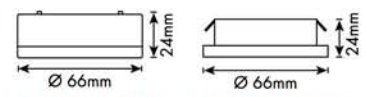

### PDL 2009R

Surface Mount

Recessed Mount

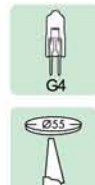

VOLTAGE: 12V  
 WATTAGE: MAX. 20W  
 LAMP TYPE: JC Capsule G4  
 CONSTRUCTION: Polycarbonate  
 IP RATING: IP44  
 IND. BOX: 100 x 100 x 47 mm  
 CTN SIZE / PCS.: 520 x 210 x 490 mm / 100 pcs.  
 WEIGHT (KG) G.W. / N.W.: 7.5 / 6 kg

CASING COLOUR:

WH WHITE BR BRASS CR CHROME BK BROWN GR GREY BK BLACK

## BATHROOM Downlights

### ADL90S-LV

*Semi-recessed Mount*

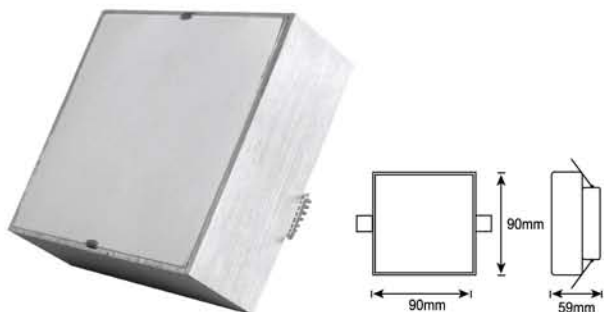

VOLTAGE: 12V

WATTAGE: Max. 50W

LAMP TYPE: MR16



CONSTRUCTION: Glass and Aluminium casing

IP RATING: IP44

IND. BOX: 115 x 95 x 65 mm

CTN SIZE / PCS.: 495 x 245 x 355 mm / 50 pcs.

WEIGHT (KG) G.W. / N.W.: 18 / 17 kg

CASING COLOUR: SILVER GREY

### ADL110S-LV

*Semi-recessed Mount*

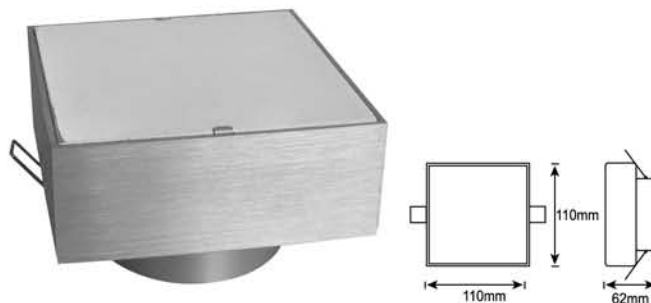

VOLTAGE: 12V

WATTAGE: Max. 50W

LAMP TYPE: MR16



CONSTRUCTION: Glass and Aluminium casing

IP RATING: IP44

IND. BOX: 125 x 115 x 70 mm

CTN SIZE / PCS.: 595 x 265 x 380 mm / 50 pcs.

WEIGHT (KG) G.W. / N.W.: 22 / 21 kg

CASING COLOUR: SILVER GREY

### ADL90R-LV

*Semi-recessed Mount*



VOLTAGE: 12V

WATTAGE: Max. 50W

LAMP TYPE: MR16



CONSTRUCTION: Glass and Aluminium casing

IP RATING: IP44

IND. BOX: 95 x 95 x 65 mm

CTN SIZE / PCS.: 495 x 205 x 355 mm / 50 pcs.

WEIGHT (KG) G.W. / N.W.: 13.5 / 12.5 kg

CASING COLOUR: SILVER GREY

### ADL140R-LV

*Semi-recessed Mount*

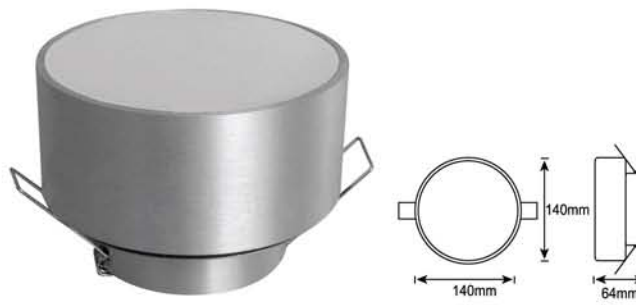

VOLTAGE: 12V

WATTAGE: Max. 50W

LAMP TYPE: MR16



CONSTRUCTION: Glass and Aluminium casing

IP RATING: IP44

IND. BOX: 145 x 145 x 70 mm

CTN SIZE / PCS.: 745 x 305 x 380 mm / 50 pcs.

WEIGHT (KG) G.W. / N.W.: 25 / 24 kg

CASING COLOUR: SILVER GREY

## BATHROOM Spot light IP44

### BSW101PS



VOLTAGE:	230V
WATTAGE:	Max. 35W
LAMP TYPE:	GU10 / CFL
CONSTRUCTION:	Steel and Aluminium Alloy
IP RATING:	IP44
IND. BOX:	135 x 115 x 145 mm
CTN SIZE / PCS.:	470 x 275 x 440 mm / 24pcs.
WEIGHT (KG) G.W. / N.W.:	15 / 13 kg

• 7W CFL - GU10 Version Available

### BSC102B

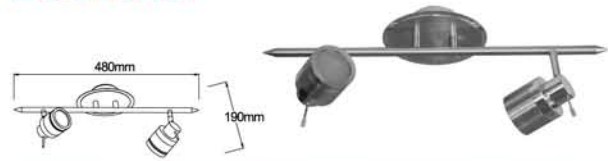

VOLTAGE:	230V
WATTAGE:	2 x 35W Max.
LAMP TYPE:	GU10 / CFL
CONSTRUCTION:	Steel and Aluminium Alloy
IP RATING:	IP44
IND. BOX:	190 x 115 x 525 mm
CTN SIZE / PCS.:	530 x 365 x 390 mm / 6pcs.
WEIGHT (KG) G.W. / N.W.:	8.8 / 6.8 kg

• 7W CFL - GU10 Version Available

### BSW201PS



VOLTAGE:	230V
WATTAGE:	Max. 35W
LAMP TYPE:	GU10 / CFL
CONSTRUCTION:	Steel and Aluminium Alloy
IP RATING:	IP44
IND. BOX:	115 x 70 x 400 mm
CTN SIZE / PCS.:	435 x 405 x 475 mm / 24pcs.
WEIGHT (KG) G.W. / N.W.:	15.5 / 13.8 kg

• 7W CFL - GU10 Version Available

### BSC103C

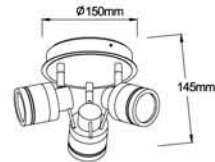

VOLTAGE:	230V
WATTAGE:	3 x 35W Max.
LAMP TYPE:	GU10 / CFL
CONSTRUCTION:	Steel and Aluminium Alloy
IP RATING:	IP44
IND. BOX:	260 x 260 x 145 mm
CTN SIZE / PCS.:	590 x 265 x 525 mm / 8pcs.
WEIGHT (KG) G.W. / N.W.:	12.8 / 10.8 kg

• 7W CFL - GU10 Version Available

### BSC104B

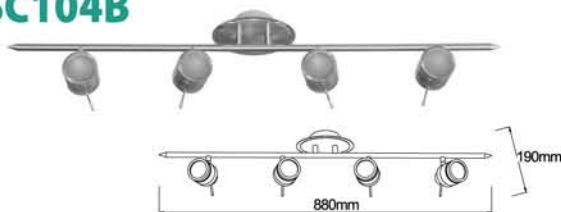

VOLTAGE:	230V
WATTAGE:	4 x 35W Max.
LAMP TYPE:	GU10 / CFL
CONSTRUCTION:	Steel and Aluminium Alloy
IP RATING:	IP44
IND. BOX:	190 x 115 x 900 mm
CTN SIZE / PCS.:	905 x 360 x 390 mm / 6pcs.
WEIGHT (KG) G.W. / N.W.:	13 / 11 kg

• 7W CFL - GU10 Version Available

### BSC203C

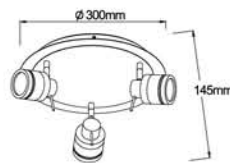

VOLTAGE:	230V
WATTAGE:	3 x 35W Max.
LAMP TYPE:	GU10 / CFL
CONSTRUCTION:	Steel and Aluminium Alloy
IP RATING:	IP44
IND. BOX:	345 x 345 x 145 mm
CTN SIZE / PCS.:	700 x 445 x 350 mm / 6pcs.
WEIGHT (KG) G.W. / N.W.:	16.5 / 14.5 kg

• 7W CFL - GU10 Version Available

## BATHROOM Ceiling Light

### CLM101/ 102/ 103

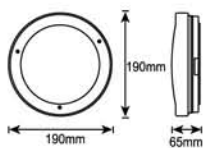

**CLM101-DD10**  
**CLM101-E14**

VOLTAGE: 230V  
WATTAGE: 10W / Max. 40W  
LAMP TYPE: DD / CANDEL E14  
CONSTRUCTION: Opal glass diffuser and metal casing  
IP RATING: IP44  
IND. BOX: 220 x 100 x 220 mm  
CTN SIZE / PCS.: 515 x 220 x 445 mm / 10 pcs.  
WEIGHT (KG) G.W. / N.W.: 7 / 5.5 kg

CASING COLOUR: SATIN NICKEL

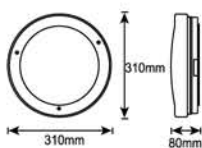

**CLM102-DD21**

VOLTAGE: 230V  
WATTAGE: 21W  
LAMP TYPE: DD  
CONSTRUCTION: Opal glass diffuser and metal casing  
IP RATING: IP44  
IND. BOX: 340 x 130 x 340 mm  
CTN SIZE / PCS.: 665 x 340 x 340 mm / 5 pcs.  
WEIGHT (KG) G.W. / N.W.: 8 / 6.5 kg

CASING COLOUR: SATIN NICKEL

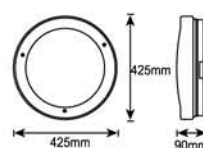

**CLM103-DD28**  
**CLM103-DD38**

VOLTAGE: 230V  
WATTAGE: 28W/ 38W  
LAMP TYPE: DD  
CONSTRUCTION: Opal glass diffuser and metal casing  
IP RATING: IP44  
IND. BOX: 450 x 140 x 450 mm  
CTN SIZE / PCS.: 570 x 450 x 450 mm / 4 pcs.  
WEIGHT (KG) G.W. / N.W.: 11.5 / 10 kg

CASING COLOUR: SATIN NICKEL

### CL3T



VOLTAGE: 230V  
WATTAGE: 16W/ 28W  
LAMP TYPE: DD  
CONSTRUCTION: Opal glass diffuser and metal casing  
IP RATING: IP20/ IP44  
IND. BOX: 310 x 130 x 308 mm  
CTN SIZE / PCS.: 635 x 405 x 320 / 6 pcs.  
WEIGHT (KG) G.W. / N.W.: 10.2 / 8.7 kg

• Completed with White, Brass & Chrome trims

### AJ2031

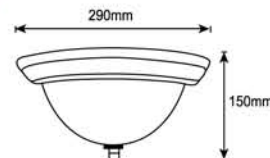

VOLTAGE: 230V  
WATTAGE: Max. 60W  
LAMP TYPE: GLS / CFL E27  
CONSTRUCTION: Opal glass diffuser and metal casing  
IP RATING: IP44  
IND. BOX: 313 x 170 x 310 mm  
CTN SIZE / PCS.: 330 x 530 x 640 mm / 6 pcs.  
WEIGHT (KG) G.W. / N.W.: 11.2 / 9 kg

CASING COLOUR: SATIN NICKEL

# BATHROOM PIR Downlight & Mirror Light

## PIR Sensor Downlight

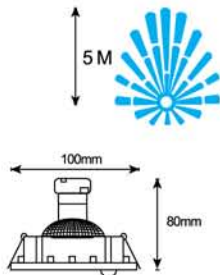

### AC-6001/PIR100



VOLTAGE:	230V
WATTAGE:	Max. 50W
LAMP TYPE:	GU10
CONSTRUCTION:	Aluminium alloy casing
IP RATING:	IP20
IND. BOX:	203 x 100 x 125 mm
CTN SIZE / PCS.:	520 x 423 x 270 mm / 20 pcs.
WEIGHT (KG) G.W. / N.W.:	11 / 9.7 kg

CASING COLOUR:  WH WHITE  BK BLACK  CR CHROME  SN SATIN NICKEL

## Display Arm Light



### DAG225G91P



VOLTAGE:	120V / 230V
WATTAGE:	2 x 25W Max.
LAMP TYPE:	JCD G9
CONSTRUCTION:	Aluminium casing with copper rod and tempered glass tube
IP RATING:	IP44
IND. BOX:	258 x 104 x 55 mm
CTN SIZE / PCS.:	545 x 460 x 305 mm / 40 pcs.
WEIGHT (KG) G.W. / N.W.:	13.2 / 11.7 kg

CASING COLOUR:  SG SILVER GREY

## Mirror Clip Light

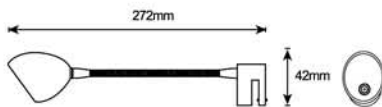

### MCL05-CR



VOLTAGE:	12V
WATTAGE:	Max. 20W
LAMP TYPE:	JC Capsule G4
CONSTRUCTION:	Glass, metal and aluminium alloy casing
IP RATING:	IP20
IND. BOX:	105 x 90 x 150 mm
CTN SIZE / PCS.:	545 x 470 x 330 mm / 50 pcs.
WEIGHT (KG) G.W. / N.W.:	12.5 / 11.5 kg

CASING COLOUR:  CR CHROME

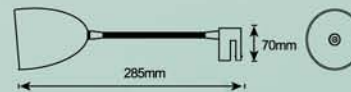
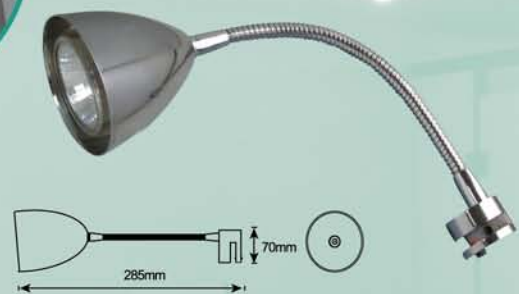

### MCL06-CR



VOLTAGE:	12V
WATTAGE:	Max. 50W
LAMP TYPE:	MR16
CONSTRUCTION:	Metal and aluminium alloy casing
IP RATING:	IP20
IND. BOX:	105 x 90 x 150 mm
CTN SIZE / PCS.:	545 x 470 x 330 mm / 50 pcs.
WEIGHT (KG) G.W. / N.W.:	12.5 / 11.5 kg

CASING COLOUR:  WH WHITE  BK BLACK  CR CHROME  SN SATIN NICKEL

## BATHROOM Mirror Light

### T4 Fluorescent Mirror Light

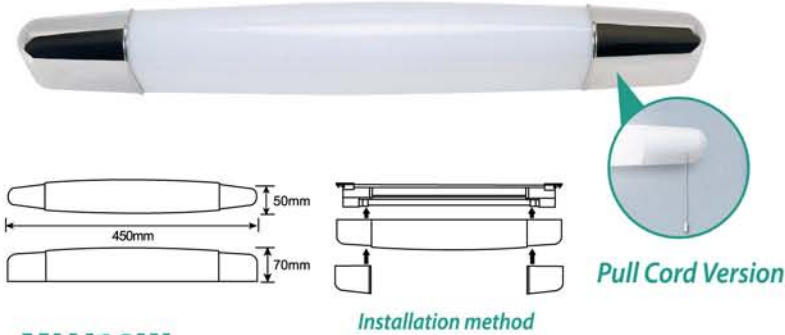

#### MLV10W

VOLTAGE:	230V
WATTAGE:	10W
LAMP TYPE:	T4 triphosphor fluorescent tube( included )
CONSTRUCTION:	PC casing with PMMA diffuser
IP Rating:	20
IND. BOX:	563 x 73 x 53 mm
CTN SIZE / PCS.:	590 x 400 x 265 mm / 20pcs
WEIGHT (KG) G.W. / N.W.:	13 / 10 kg

\* Pull Cord Model: MLV10WPS

#### MLV16W

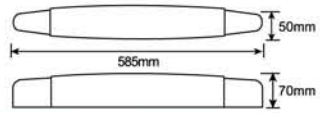

VOLTAGE:	230V
WATTAGE:	16W
IND. BOX:	688 x 73 x 53 mm
CTN SIZE / PCS.:	710 x 400 x 265 mm / 20pcs
WEIGHT (KG) G.W. / N.W.:	14 / 10.4 kg

\* Pull Cord Model: MLV16WPS

### Shaver Light



#### SV60D

VOLTAGE:	230V
WATTAGE:	60W
LAMP TYPE:	Double Ended Strip Lamp
CONSTRUCTION:	Plastic casing
IP Rating:	20
IND. BOX:	502 x 77 x 77mm
CTN SIZE / PCS.:	515 x 170 x 175mm / 4 pcs.
WEIGHT (KG) G.W. / N.W.:	5 / 4 kg

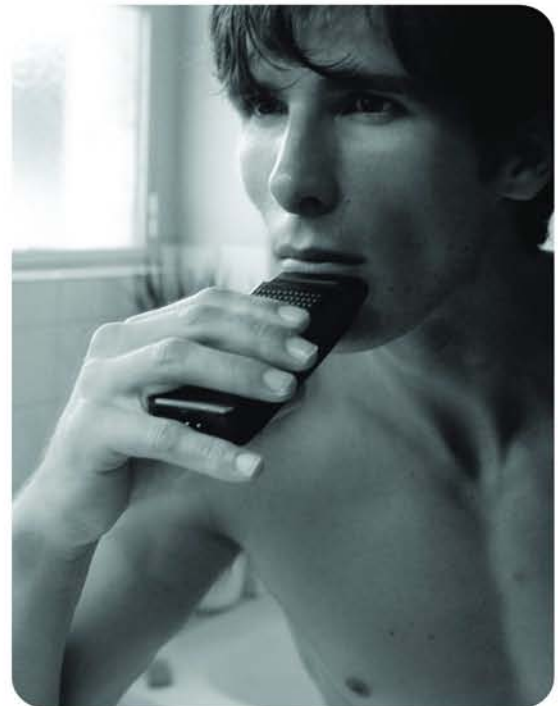

## BATHROOM Mirror/Wall light

### WL401-CH



VOLTAGE: 230V  
 WATTAGE: Max. 25W  
 LAMP TYPE: JCD G9  
 CONSTRUCTION: Glass, metal and aluminium casing  
 IP RATING: IP20  
 IND. BOX: 80 x 80 x 135 mm  
 CTN SIZE / PCS.: 505 x 340 x 300 mm / 50 pcs.  
 WEIGHT (KG) G.W. / N.W.: 12.83 / 11.83 kg

CASING COLOUR: BR BRASS CR CHROME SN SATIN NICKEL

### WL404-CH



VOLTAGE: 230V  
 WATTAGE: 2 x 25W Max.  
 LAMP TYPE: JCD G9  
 CONSTRUCTION: Glass, metal and aluminium casing  
 IP RATING: IP20  
 IND. BOX: 130 x 85 x 180 mm  
 CTN SIZE / PCS.: 520 x 275 x 390 mm / 50 pcs.  
 WEIGHT (KG) G.W. / N.W.: 11.93 / 10.93 kg

CASING COLOUR: BR BRASS CR CHROME SN SATIN NICKEL

### WL405-CH



VOLTAGE: 230V  
 WATTAGE: Max. 25W  
 LAMP TYPE: JCD G9  
 CONSTRUCTION: Glass, metal and aluminium casing  
 IP RATING: IP20  
 IND. BOX: 160 x 85 x 125 mm  
 CTN SIZE / PCS.: 360 x 335 x 405 mm / 50 pcs.  
 WEIGHT (KG) G.W. / N.W.: 8.78 / 7.78 kg

CASING COLOUR: BR BRASS CR CHROME SN SATIN NICKEL

### WL407-CH



VOLTAGE: 230V  
 WATTAGE: 2 x 25W Max.  
 LAMP TYPE: JCD G9  
 CONSTRUCTION: Glass, metal and aluminium casing  
 IP RATING: IP20  
 IND. BOX: 130 x 85 x 180 mm  
 CTN SIZE / PCS.: 520 x 275 x 539 mm / 50 pcs.  
 WEIGHT (KG) G.W. / N.W.: 11.93 / 10.93 kg

CASING COLOUR: BR BRASS CR CHROME SN SATIN NICKEL





# LUEN YICK ELECTRICAL MFG. CO., LTD.

Hong Kong  
Head Office  
香港總公司

LUEN YICK ELECTRICAL MFG. CO., LTD.  
聯益電器製品廠有限公司

Flat F,10/F, Blk. 2, Kingsford Ind. Bldg., 26-32 Kwai Hei St., Kwai Chung, N.T., Hong Kong  
香港新界葵涌葵喜街26至32號金發工業大廈第二期10字樓F座

Tel 電話 : (852) 2407 8836

Fax 傳真 : (852) 2419 8200

Email 電郵 : sales@luenyick-elec.com

Web Site 網址 : www.kengo.com

China  
Subsidiary Office  
國內分處

LuenYick (Wuxi) Lighting & Electrical Co., Ltd.  
联益(无锡)照明电器有限公司

105 Xigang W.Road, Xibei Town, 214194, WuXi, Jiangsu, China  
江苏省无锡市锡北镇锡港西路105号 邮编:214194

Tel 电话: (86) 510 8379 9888

Fax 传真: (86) 510 8379 5005

Email 电邮: sales@kengo.com.cn

Web Site 网址 : www.kengo.com.cn

Kengo Lighting  
Turkey

Kengo Aydinlatma San. ve Diş Tic. Ltd. Şti.

Okçu Musa Caddesi, Şair Eşref Sok, Nurlu Han No: 13, Kat: 3/4/5/6, Beyoğlu 34420, İstanbul

Tel: + 90 212 293 06 06 bpx

Fax: + 90 212 293 06 96

Email: kengo@kengo.com.tr

China  
Factory  
国内工厂

Boluo Xian Shek Wan Luen Yick Plastic Metal & Electrical Factory  
博罗县石湾联益塑胶五金电器厂

Zhang Gang, Ye Wu Cun, Shi Wan Zhen,  
Boluo Xian, Hui Zhou City, Guang Dong Province China.  
广东省惠州市博罗县石湾镇中岗叶屋村 邮编:516127

Tel 电话 : (86) 752 6913606

Fax 传真 : (86) 752 6913613

Email 电邮: sales@luenyick-elec.com

Web Site 网址 : www.kengo.com



ISO 9001:2000  
Certificate No.: FM 85977