





**Mini contactors B 6/4 kW;
B 7/5.5 kW**

Mini contactor relays K..

Compact reversing contactors VB..

Thermal overload relay T 7 DU

Contents

Mini contactors and B 6, BC 6, B 7, BC 7

Ordering details 4

Compact reversing contactors

Ordering details 5

Interface motor contactors

Ordering details 7

Mini motor contactors relays, interface contactor relays

Ordering details 8

Mini motor contactors TBC 7, Mini contactor relays TKC 6

Ordering details 9

Technical data 9

Accessories for mini contactors 9

Mini motor contactors, Compact reversing contactors, Mini contactor relays

Technical data 11

Approvals 15

Dimensions diagrams 17

Coil voltages for mini contactors

B 6, B 7, VB 6(A), VB 7(A), BC 6, BC 7, VBC 6(A), VBC 7(A), K 6, KC 6.

AC		DC	
40-450 Hz	Code number	DC	Code number
V ①	" .. "	V	" .. "
24	0 .. 1	12	0 .. 7
42	0 .. 2	24	0 .. 1
48	0 .. 3	42	0 .. 2
110 ... 127	8 .. 4	48	1 .. 6
220 ... 240	8 .. 0	60	0 .. 3
380 ... 415	8 .. 5	110 ... 125	0 .. 4
		220 ... 240	0 .. 5

① Coil voltage range: $0.85 \dots 1.1 \times U_c$

Mini motor contactors B 6, BC 6, B 7, BC 7

Ordering details



B 6-30-10

SST 158 91 R

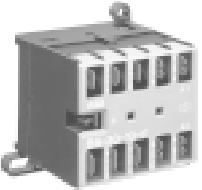

BC 6-30-10-F

SST 159 91 R



B 6-30-10-P

SST 161 91 R



B 7-30-10

SST 168 91 APS

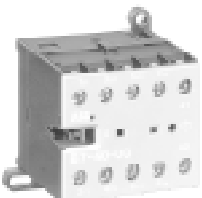

B 7-40-00

SST 110 93 R



B 7-40-00 with auxiliary switch CAF 6-11 screwed on afterwards

SST 009 93 R

Type	Order code See Page 3 for adding code suffixes " .. " to the order code	Auxiliary switches		Motor output 220 V 240 V kW	AC2...3 380 V 440 1V kW	Price per piece	Packing unit piece	Weight per piece kg
		NO	NC					

Mini motor contactors B 6

Mini contactors, with screw connection, for AC operation, 3.5 VA

B 6-30-10	GJL 121 1001 R " 10 "	1	0	2.2	4		10	0.180
B 6-30-01	GJL 121 1001 R " 01 "	0	1				10	0.180
B 6-40-00	GJL 121 1201 R " 00 "	0	0				10	0.180

Mini contactors, with flat pin connection, for AC operation, 3.5 VA

B 6-30-10-F	GJL 121 1003 R " 10 "	1	0	2.2	4		10	0.170
B 6-30-01-F	GJL 121 1003 R " 01 "	0	1				10	0.170
B 6-40-00-F	GJL 121 1203 R " 00 "	0	0				10	0.170

Mini contactors, with soldering pins, for AC operation, 3.5 VA, $I_{th} < 8 A$

B 6-30-10-P	GJL 121 1009 R " 10 "	1	0	2.2	4		10	0.170
B 6-30-01-P	GJL 121 1009 R " 01 "	0	1				10	0.170

Mini contactors, with screw connection, for DC operation, 3.5 W

BC 6-30-10	GJL 121 3001 R " 10 "	1	0	2.2	4		100	0.180
BC 6-30-01	GJL 121 3001 R " 01 "	0	1				10	0.180

Mini contactors, with flat pin connection, for DC operation, 3.5 W

BC 6-30-10-F	GJL 121 3003 R " 10 "	1	0	2.2	4		10	0.170
BC 6-30-01-F	GJL 121 3003 R " 01 "	0	1				10	0.170

Mini contactors, with soldering pins, for DC operation, 3.5 W, $I_{th} < 8 A$

BC 6-30-10-P	GJL 121 3009 R " 10 "	1	0	2.2	4		10	0.170
BC 6-30-01-P	GJL 121 3009 R " 01 "	0	1				10	0.170

Mini motor contactors B 7

Mini contactors, with screw connection, for AC operation, 3.5 VA

B 7-30-10	GJL 131 1001 R " 10 "	1	0	3.0	5.5		10	0.180
B 7-30-01	GJL 131 1001 R " 01 "	0	1				10	0.180
B 7-40-00	GJL 131 1201 R " 00 "	0	0				10	0.180

Mini contactors, with flat pin connection, for AC operation, 3.5 VA

B 7-30-10-F	GJL 131 1003 R " 10 "	1	0	3.0	5.5		10	0.170
B 7-30-01-F	GJL 131 1003 R " 01 "	0	1				10	0.170
B 7-40-00-F	GJL 131 1203 R " 00 "	0	0				10	0.170

Mini contactors, with soldering pins, for AC operation, 3.5 VA, $I_{th} < 8 A$

B 7-30-10-P	GJL 131 1009 R " 10 "	1	0	3.0	5.5		10	0.170
B 7-30-01-P	GJL 131 1009 R " 01 "	0	1				10	0.170

Mini contactors, with screw connection, for DC operation, 3.5 W

BC 7-30-10	GJL 131 3001 R " 10 "	1	0	3.0	5.5		10	0.180
BC 7-30-01	GJL 131 3001 R " 01 "	0	1				10	0.180

Mini contactors, with flat pin connection, for DC operation, 3.5 W

BC 7-30-10-F	GJL 131 3003 R " 10 "	1	0	3.0	5.5		10	0.170
BC 7-30-01-F	GJL 131 3003 R " 01 "	0	1				10	0.170

Mini contactors, with screw connection, for 24 V DC operation, with integr. surpressor diod, 3.5 W

B 7 D-30-10	GJL 131 7001 R 0101	1	0	3.0	5.5		10	0.170
B 7 D-30-01	GJL 131 7001 R 0011	0	1				10	0.170
B 7 D-40-00	GJL 131 7201 R 0001	0	0				10	0.170

Mini contactors, with soldering pins, for DC operation, 3.5 W, $I_{th} < 8 A$

BC 7-30-10-P	GJL 131 3009 R " 10 "	1	0	3.0	5.5		10	0.170
BC 7-30-01-P	GJL 131 3009 R " 01 "	0	1				10	0.170

Mini contactors, with screw connection, for 220 V DC operation, with integr. surpressor diod, 3.5 W

B 7 D-30-10	GJL 131 7001 R 0105	1	0	3.0	5.5		10	0.170
B 7 D-30-01	GJL 131 7001 R 0015	0	1				10	0.170
B 7 D-40-00	GJL 131 7201 R 0005	0	0				10	0.170

Compact reversing contactors

Ordering details

Compact reversing contactors VB 6, VB 7 and VB 6A, VB 7A

The mechanical interlock between the two contactors mechanically prevents switch-on of one contactor for as long as the other contactor is still on and vice versa. If reversing contactors are switched over too quickly, this involves the risk of a phase-to-phase short-circuit. This will be the case if the arc of the contactor switching off has not yet been quenched when the contacts of the contactor switching on are already closed.

In order to avoid these risks, both contactor coils must be de-energised **for at least 50 ms** and must also be mutually interlocked electrically.

The compact reversing contactors are offered with two different mechanical interlocks:

- VB 6 resp. VB 7: normal interlock
- VB 6A resp. VB 7A: interlock with mechanical safety blocking function

The safety blocking function is triggered if the voltage is applied to the coil of the contactor to be switched on before the contactor to be switched off has dropped out.

Safety blocking means that the contactor to be switched on is locked mechanically in OFF condition owing to the switch-on signal issued too early, and this state is retained until the blocking function is cancelled again as follows:

disconnect the voltage from the two contactor coils and then reconnect the voltage to the coil of the contactor to be switched on.

The contactor coils are designed for continuous operation when the contactor is de-energised, i.e. the coil is not damaged if the mechanical interlock prevents switch-on of the contactor with the coil voltage applied.

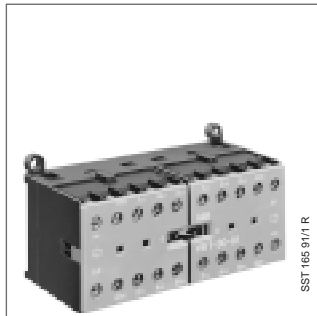

VB 7-30-01

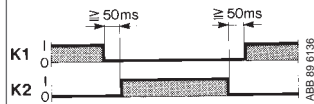

When the direction of rotation is changed, both contactor coils of VB 6A, VB 7A have to be de-energized for more than 50 ms.

Type	Order code See Page 3 for adding code suffixes "..." to the order code	Auxiliary switches		Motor output AC2...3		Price per piece	Pack- ing unit piece	Weight per piece kg
		NO	NC	max. 220 V 240 V kW	380 V 440 V kW			

Compact reversing contactors VB 6, VBC 6, with mechanical interlock

Reversing contactors, with screw connection, for AC operation, 3.5 VA

VB 6-30-10	GJL 121 1901 R " 10 "	1	0	2.2	4	5	0.340
VB 6-30-01	GJL 121 1901 R " 01 "	0	1			5	0.340

Reversing contactors, with flat pin connection, for AC operation, 3.5 VA

VB 6-30-10-F	GJL 121 1903 R " 10 "	1	0	2.2	4	5	0.340
VB 6-30-01-F	GJL 121 1903 R " 01 "	0	1			5	0.340

Reversing contactors, with soldering pins, for AC operation, 3.5 VA, $I_{th} < 8 A$

VB 6-30-10-P	GJL 121 1909 R " 10 "	1	0	2.2	4	5	0.340
VB 6-30-01-P	GJL 121 1909 R " 01 "	0	1			5	0.340

Reversing contactors, with screw connection, for DC operation, 3.5 W

VBC 6-30-10	GJL 121 3901 R " 10 "	1	0	2.2	4	5	0.340
VBC 6-30-01	GJL 121 3901 R " 01 "	0	1			5	0.340

Reversing contactors, with flat pin connection, for DC operation, 3.5 W

VBC 6-30-10-F	GJL 121 3903 R " 10 "	1	0	2.2	4	5	0.340
VBC 6-30-01-F	GJL 121 3903 R " 01 "	0	1			5	0.340

Reversing contactors, with soldering pins, for DC operation, 3.5 W, $I_{th} < 8 A$

VBC 6-30-10-P	GJL 121 3909 R " 10 "	1	0	2.2	4	5	0.340
VBC 6-30-01-P	GJL 121 3909 R " 01 "	0	1			5	0.340

Compact reversing contactors VB 7, VBC 7, with mechanical interlock

Reversing contactors, with screw connection, for AC operation, 3.5 VA

VB 7-30-10	GJL 131 1901 R " 10 "	1	0	3.0	5.5	5	0.340
VB 7-30-01	GJL 131 1901 R " 01 "	0	1			5	0.340

Reversing contactors, with flat pin connection, for AC operation, 3.5 VA

VB 7-30-10-F	GJL 131 1903 R " 10 "	1	0	3.0	5.5	5	0.340
VB 7-30-01-F	GJL 131 1903 R " 01 "	0	1			5	0.340

Reversing contactors, with soldering pins, for AC operation, 3.5 VA, $I_{th} < 8 A$

VB 7-30-10-P	GJL 131 1909 R " 10 "	1	0	3.0	5.5	5	0.340
VB 7-30-01-P	GJL 131 1909 R " 01 "	0	1			5	0.340

Reversing contactors, with screw connection, for DC operation, 3.5 W

VBC 7-30-10	GJL 131 3901 R " 10 "	1	0	3.0	5.5	5	0.340
VBC 7-30-01	GJL 131 3901 R " 01 "	0	1			5	0.340

Reversing contactors, with flat pin connection, for DC operation, 3.5 W

VBC 7-30-10-F	GJL 131 3903 R " 10 "	1	0	3.0	5.5	5	0.340
VBC 7-30-01-F	GJL 131 3903 R " 01 "	0	1			5	0.340

Reversing contactors, with soldering pins, for DC operation, 3.5 W, $I_{th} < 8 A$

VBC 7-30-10-P	GJL 131 3909 R " 10 "	1	0	3.0	5.5	5	0.340
VBC 7-30-01-P	GJL 131 3909 R " 01 "	0	1			5	0.340

Compact reversing contactors

Ordering details

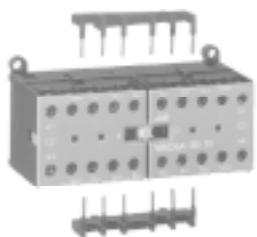

SST 276 92 R

Reversing contactor VBC 6A-3-10
Reversing connection BMS 6-30

Type	Order code See Page 3 for adding code suffixes "..." to the order code	Auxiliary switches		Motor output AC2...3		Price per unit	Pack- ing unit piece	Weight per piece kg
		NO	NC	220 V 240 V kW	380 V 440 V kW			

Compact reversing contactors VB 6A, VBC 6A, with mechanical interlock

Reversing contactors, with screw connection, for AC operation, 3.5 VA

VB 6A-30-10	GJL 121 1911 R " 10 "	1	0	2.2	4	5	0.340
VB 6A-30-01	GJL 121 1911 R " 01 "	0	1			5	0.340

Reversing contactors, with flat pin connection, for AC operation, 3.5 VA

VB 6A-30-10-F	GJL 121 1913 R " 10 "	1	0	2.2	4	5	0.340
VB 6A-30-01-F	GJL 121 1913 R " 01 "	0	1			5	0.340

Reversing contactors, with soldering pins, for AC operation, 3.5 VA, $I_{th} < 8 A$

VB 6A-30-10-P	GJL 121 1919 R " 10 "	1	0	2.2	4	5	0.340
VB 6A-30-01-P	GJL 121 1919 R " 01 "	0	1			5	0.340

Reversing contactors, with screw connection, for DC operation, 3.5 W

VBC 6A-30-10	GJL 121 3911 R " 10 "	1	0	2.2	4	5	0.340
VBC 6A-30-01	GJL 121 3911 R " 01 "	0	1			5	0.340

Reversing contactors, with flat pin connection, for DC operation, 3.5 W

VBC 6A-30-10-F	GJL 121 3913 R " 10 "	1	0	2.2	4	5	0.340
VBC 6A-30-01-F	GJL 121 3913 R " 01 "	0	1			5	0.340

Reversing contactors, with soldering pins, for DC operation, 3.5 W, $I_{th} < 8 A$

VBC 6A-30-10-P	GJL 121 3919 R " 10 "	1	0	2.2	4	5	0.340
VBC 6A-30-01-P	GJL 121 3919 R " 01 "	0	1			5	0.340

Compact reversing contactors VB 7A, VBC 7A, with mechanical interlock

Reversing contactors, with screw connection, for AC operation, 3.5 VA

VB 7A-30-10	GJL 131 1911 R " 10 "	1	0	3.0	5.5	5	0.340
VB 7A-30-01	GJL 131 1911 R " 01 "	0	1			5	0.340

Reversing contactors, with flat pin connection, for AC operation, 3.5 VA

VB 7A-30-10-F	GJL 131 1913 R " 10 "	1	0	3.0	5.5	5	0.340
VB 7A-30-01-F	GJL 131 1913 R " 01 "	0	1			5	0.340

Reversing contactors, with soldering pins, for AC operation, 3.5 VA, $I_{th} < 8 A$

VB 7A-30-10-P	GJL 131 1919 R " 10 "	1	0	3.0	5.5	5	0.340
VB 7A-30-01-P	GJL 131 1919 R " 01 "	0	1			5	0.340

Reversing contactors, with screw connection, for DC operation, 3.5 W

VBC 7A-30-10	GJL 131 3911 R " 10 "	1	0	3.0	5.5	5	0.340
VBC 7A-30-01	GJL 131 3911 R " 01 "	0	1			5	0.340

Reversing contactors, with flat pin connection, for DC operation, 3.5 W

VBC 7A-30-10-F	GJL 131 3913 R " 10 "	1	0	3.0	5.5	5	0.340
VBC 7A-30-01-F	GJL 131 3913 R " 01 "	0	1			5	0.340

Reversing contactors, with soldering pins, for DC operation, 3.5 W, $I_{th} < 8 A$

VBC 7A-30-10-P	GJL 131 3919 R " 10 "	1	0	3.0	5.5	5	0.340
VBC 7A-30-01-P	GJL 131 3919 R " 01 "	0	1			5	0.340

Interface motor contactors

Mini contactors for connection to PLCs

Ordering details



BC 7-30-10- 1.4

ABB 85 08441/R

Interface motor contactors BC 6

Auxiliary switch blocks **cannot** be fitted later on !

Type	Order code	Auxiliary switches		Motor output		Price per piece	Pack- ing unit piece	Weight per piece kg	
		NO	NC	220 V	AC2...3				240 V
				kW					
Motor contactors, with screw connection, for DC operation 24V / 1.4 W									
BC 6-30-10-1.4	GJL 121 3001 R 8101	1	0	2.2	4		10	0.180	
BC 6-30-01-1.4	GJL 121 3001 R 8011	0	1	2.2	4		10	0.180	
Motor contactors, with flat pin connection, for DC operation 24V / 1.4 W									
BC 6-30-10-F-1.4	GJL 121 3003 R 8101	1	0	2.2	4		10	0.180	
BC 6-30-01-F-1.4	GJL 121 3003 R 8011	0	1	2.2	4		10	0.180	
Motor contactors, with soldering pins, for DC operation 24V / 1.4 W, I_{th} < 8 A									
BC 6-30-10-P-1.4	GJL 121 3009 R 8101	1	0	2.2	4		10	0.170	
BC 6-30-01-P-1.4	GJL 121 3009 R 8011	0	1	2.2	4		10	0.170	
Motor contactors, with screw connection, for DC operation 17 ... 32 V / 2.4 W									
BC 6-30-10-2.4	GJL 121 3001 R 5101	1	0	2.2	4		10	0.180	
BC 6-30-01-2.4	GJL 121 3001 R 5011	0	1	2.2	4		10	0.180	
Motor contactors, with flat pin connection, for DC operation 17 ... 32 V / 2.4 W									
BC 6-30-10-F-2.4	GJL 121 3003 R 5101	1	0	2.2	4		10	0.170	
BC 6-30-01-F-2.4	GJL 121 3003 R 5011	0	1	2.2	4		10	0.170	
Motor contactors, with soldering pins, for DC operation 17 ... 32 V / 2.4 W, I_{th} < 8 A									
BC 6-30-10-P-2.4	GJL 121 3009 R 5101	1	0	2.2	4		10	0.170	
BC 6-30-01-P-2.4	GJL 121 3009 R 5011	0	1	2.2	4		10	0.170	

Interface motor contactors BC 7

Auxiliary switch blocks **cannot** be fitted later on !

Motor contactors, with screw connection, for DC operation 24V / 1.4 W									
BC 7-30-10-1.4	GJL 131 3001 R 8101	1	0	3.0	5.5		10	0.170	
BC 7-30-01-1.4	GJL 131 3001 R 8011	0	1	3.0	5.5		10	0.170	
Motor contactors, with flat pin connection, for DC operation 24V / 1.4 W									
BC 7-30-10-F-1.4	GJL 131 3003 R 8101	1	0	3.0	5.5		10	0.170	
BC 7-30-01-F-1.4	GJL 131 3003 R 8011	0	1	3.0	5.5		10	0.170	
Motor contactors, with soldering pins, for DC operation 24V / 1.4 W, I_{th} < 8 A									
BC 7-30-10-P-1.4	GJL 131 3009 R 8101	1	0	3.0	5.5		10	0.170	
BC 7-30-01-P-1.4	GJL 131 3009 R 8011	0	1	3.0	5.5		10	0.170	
Motor contactors, with screw connection, for DC operation 17 ... 32 V / 2.4 W									
BC 7-30-10-2.4	GJL 131 3001 R 5101	1	0	3.0	5.5		10	0.170	
BC 7-30-01-2.4	GJL 131 3001 R 5011	0	1	3.0	5.5		10	0.170	
Motor contactors, with flat pin connection, for DC operation 17 ... 32 V / 2.4 W									
BC 7-30-10-F-2.4	GJL 131 3003 R 5101	1	0	3.0	5.5		10	0.170	
BC 7-30-01-F-2.4	GJL 131 3003 R 5011	0	1	3.0	5.5		10	0.170	
Motor contactors, with soldering pins, for DC operation 17 ... 32 V / 2.4 W, I_{th} < 8 A									
BC 7-30-10-P-2.4	GJL 131 3009 R 5101	1	0	3.0	5.5		10	0.170	
BC 7-30-01-P-2.4	GJL 131 3009 R 5011	0	1	3.0	5.5		10	0.170	

Oscillograms

Without protective circuit

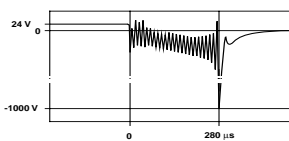

SST 016 91 K

With integrated protective circuit

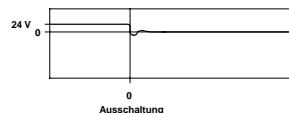

SST 016 91 K

- Controlled directly by PLC
- Integrated protective circuit with diodes and additional surge suppressor
- Non-confusable coil connection
- You save time and money for additional external wiring
- Thermal overload relay T7 DU available as accessory, see Page 19.

Mini contactors for connection to PLCs B 6 S

... with integrated protective circuit

Auxiliary switch blocks **cannot** be fitted later on !

Motor contactors with screw connection, for DC operation 24 V / 1.7 W									
B6 NO-30-10-1.7	GJL 121 3001 R7101	1	0	2.2	4.0		10	0.180	
B6 NO-30-01-1.7	GJL 121 3001 R7011	0	1	2.2	4.0		10	0.180	
Motor contactors with screw connection, for DC operation 17...32 V / 2.8 W									
B6 NO-30-10-2.8	GJL 121 3001 R7102	1	0	2.2	4.0		10	0.180	
B6 NO-30-01-2.8	GJL 121 3001 R7012	0	1	2.2	4.0		10	0.180	

Mini contactors for connection to PLCs B 7 S ... with integrated protective circuit

Auxiliary switch blocks **cannot** be fitted later on !

Motor contactors with screw connection, for DC operation 24 V / 1.7 W									
B7 NO-30-10-1.7	GJL 131 3001 R7101	1	0	3.0	5.5		10	0.180	
B7 NO-30-01-1.7	GJL 131 3001 R7011	0	1	3.0	5.5		10	0.180	
Motor contactors with screw connection, for DC operation 17...32 V / 2.8 W									
B7 NO-30-10-2.8	GJL 131 3001 R7102	1	0	3.0	5.5		10	0.180	
B7 NO-30-01-2.8	GJL 131 3001 R7012	0	1	3.0	5.5		10	0.180	

Mini contactor relays, interface contactor relays / mini contactor relays for connection to PLCs

Ordering details



KC 6-40 E-P

SST 166 91 R

Type	Order code See Page 3 for adding code suffixes " .. " to the order code	Auxiliary switches		220 V 240 V A	AC15		500 V A	Price per piece	Pack- ing unit piece	Weight per piece kg
		NO	NC		380 V 440 V A					

Mini contactor relays

Contactor relays, with screw connection, for AC operation, 3.5 VA

K 6-40 E	GJH 121 1001 R .. 40 ..	4	0	4	3	2		10	0.180
K 6-31 Z	GJH 121 1001 R .. 31 ..	3	1	4	3	2		10	0.180
K 6-22 Z	GJH 121 1001 R .. 22 ..	2	2	4	3	2		10	0.180

Contactor relays, with flat pin connection, for AC operation, 3.5 VA

K 6-40 E- F	GJH 121 1003 R .. 40 ..	4	0	4	3	2		10	0.170
K 6-31 Z- F	GJH 121 1003 R .. 31 ..	3	1	4	3	2		10	0.170
K 6-22 Z- F	GJH 121 1003 R .. 22 ..	2	2	4	3	2		10	0.170

Contactor relays, with soldering pins, for AC operation, 3.5 VA

K 6-40 E- P	GJH 121 1009 R .. 40 ..	4	0	4	3	2		10	0.170
K 6-31 Z- P	GJH 121 1009 R .. 31 ..	3	1	4	3	2		10	0.170
K 6-22 Z- P	GJH 121 1009 R .. 22 ..	2	2	4	3	2		10	0.170

Contactor relays, with screw connection, for DC operation, 3.5 W

KC 6-40 E	GJH 121 3001 R .. 40 ..	4	0	4	3	2		10	0.180
KC 6-31 Z	GJH 121 3001 R .. 31 ..	3	1	4	3	2		10	0.180
KC 6-22 Z	GJH 121 3001 R .. 22 ..	2	2	4	3	2		10	0.180

Contactor relays, with flat pin connection, for DC operation, 3.5 W

KC 6-40 E- F	GJH 121 3003 R .. 40 ..	4	0	4	3	2		10	0.170
KC 6-31 Z- F	GJH 121 3003 R .. 31 ..	3	1	4	3	2		10	0.170
KC 6-22 Z- F	GJH 121 3003 R .. 22 ..	2	2	4	3	2		10	0.170

Contactor relays, with soldering pins, for DC operation, 3.5 W

KC 6-40 E- P	GJH 121 3009 R .. 40 ..	4	0	4	3	2		10	0.170
KC 6-31 Z- P	GJH 121 3009 R .. 31 ..	3	1	4	3	2		10	0.170
KC 6-22 Z- P	GJH 121 3009 R .. 22 ..	2	2	4	3	2		10	0.170

Interface contactor relays

Auxiliary switch blocks **cannot** be fitted later on !

Contactor relay, with screw connection, for DC operation, 24 V / 1.4 W

KC 6-40 E-1.4	GJH 121 3001 R 8401	4	0	4	3	2		10	0.180
KC 6-31 Z-1.4	GJH 121 3001 R 8311	3	1	4	3	2		10	0.180

Contactor relay, with flat pin connection, for DC operation, 24 V / 1.4 W

KC 6-40 E-F-1.4	GJH 121 3003 R 8401	4	0	4	3	2		10	0.180
KC 6-31 Z-F-1.4	GJH 121 3003 R 8311	3	1	4	3	2		10	0.180

Contactor relay, with soldering pins, for DC operation, 24 V / 1.4 W

KC 6-40 E-P-1.4	GJH 121 3009 R 8401	4	0	4	3	2		10	0.170
KC 6-31 Z-P-1.4	GJH 121 3009 R 8311	3	1	4	3	2		10	0.170

Contactor relay, with screw connection, for DC operation, 17 ... 32 V / 2.4 W

KC 6-40 E-2.4	GJH 121 3001 R 5401	4	0	4	3	2		10	0.180
KC 6-31 Z-2.4	GJH 121 3001 R 5311	3	1	4	3	2		10	0.180

Contactor relay, with flat pin connection, for DC operation, 17 ... 32 V / 2.4 W

KC 6-40 E-F-2.4	GJH 121 3003 R 5401	4	0	4	3	2		10	0.170
KC 6-31 Z-F-2.4	GJH 121 3003 R 5311	3	1	4	3	2		10	0.170

Contactor relay, with soldering pins, for DC operation, 17 ... 32 V / 2.4 W

KC 6-40 E-P-2.4	GJH 121 3009 R 5401	4	0	4	3	2		10	0.170
KC 6-31 Z-P-2.4	GJH 121 3009 R 5311	3	1	4	3	2		10	0.170

Mini contactor relays for connection to PLCs K 6 S ... with integrated protective circuit

Auxiliary switch blocks **cannot** be fitted later on !

Contactor relay, with screw connection, for DC operation, 24 V / 1.7 W

K 6 NO-40 E-1.7	GJH 121 3001 R 7401	4	0	4	3	2		10	0.180
K 6 NO-31 Z-1.7	GJH 121 3001 R 7311	3	1	4	3	2		10	0.180
K 6 NO-22 Z-1.7	GJH 121 3001 R 7221	2	2	4	3	2		10	0.180

Contactor relay, with screw connection, for DC operation, 17 ... 32 V / 2.8 W

K 6 NO-40 E-2.8	GJH 121 3001 R 7402	4	0	4	3	2		10	0.180
K 6 NO-31 Z-2.8	GJH 121 3001 R 7312	3	1	4	3	2		10	0.180
K 6 NO-22 Z-2.8	GJH 121 3001 R 7222	2	2	4	3	2		10	0.180

Oscillograms

Without protective circuit

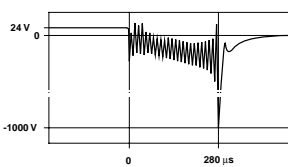

With integrated protective circuit

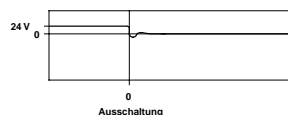

- Controlled directly by PLC
- Integrated protective circuit with diodes and additional surge suppressor
- Non-confusable coil connection
- You save time and money for additional external wiring

Mini motor contactors TBC 7

Mini contactor relays TKC 6

Railway app.: extended coil operating range, technical data

Mini motor contactors TBC 7

Type	Order code See below for adding code suffixes □, □ to the order code	Auxiliary switch NO NC	AC-1 max. 220 V 240 V A	Motor output 220 V 440 V kW	AC-2/AC-3 380 V 500 V kW	Price per piece	Pack- ing unit piece	Weight per piece kg
------	---	------------------------------	-------------------------------------	--------------------------------------	-----------------------------------	-----------------------	-------------------------------	------------------------------

Motor contactors, with screw connection, for DC operation

TBC 7-30-10	GJL 131 3061 R □ 10 □	1	0	20	3	5,5	4		10	0.180
TBC 7-30-01	GJL 131 3061 R □ 01 □	0	1	20	3	5,5	4		10	0.180

Mini contactor relays TKC 6

Contactor relays, with screw connection, for DC operation

TKC 6-22Z	GJH 121 3061 R " 22 "	2	2	6					10	0.180
TKC 6-31Z	GJH 121 3061 R " 31 "	2	2	6					10	0.180
TKC 6-40E	GJH 121 3061 R " 40 "	4	0	6					10	0.180

Contactor relays, with flat pin connection, for DC operation

TKC 6-22Z-F	GJH 121 3063 R " 22 "	2	2	6					10	0.180
TKC 6-31Z-F	GJH 121 3063 R " 31 "	2	2	6					10	0.180
TKC 6-40E-F	GJH 121 3063 R " 40 "	4	0	6					10	0.180

Coil code numbers

Coil voltage ranges

Example:

TBC 7-30-10	GJL 131 3061 R " 10 "	1	0	20	3	5,5	4		10	0.180
-------------	-----------------------	---	---	----	---	-----	---	--	----	-------



17 ... **24** ... 32 V DC = **5** .. **1**

50 ... **70** ... 90 V DC = **5** .. **5**

77 ... **110** ... 143 V DC = **6** .. **2**

140 ... **200** ... 260 V DC = **6** .. **8**

Coil data

Power consumption of coils

at U_{max} (20 °C): operate/hold ≤ 5 W

Reliable drop-out: $\leq 0.2 \times U_c$ (U_c = Rated operating voltage)

Reliable pick-up: $\geq U_{c \min}$

The voltages specified in the table are absolute limit values!

It is not permitted to attach auxiliary switch blocks CA 6 or CAF 6.

Technical data of TBC 7, TKC 6

Permissible ambient temperatures

including self-heating °C | -30 ... +55

not including self-heating °C | -30 ... +70

Storage temperature °C | -40 ... +85

All other technical data and dimensions correspond to Types BC 7 and KC 6.

Accessories for mini contactors

Ordering details

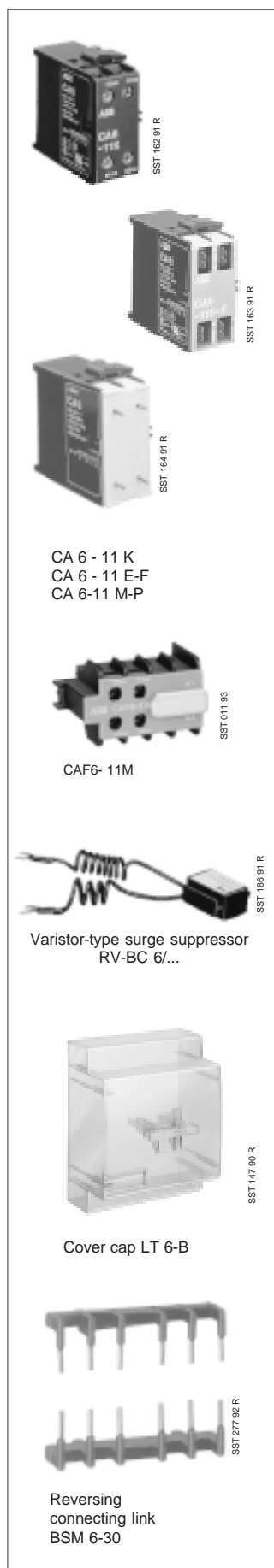

Type	Order code	For mini contactor	Price per unit	Packing unit	Weight per piece
		Type		Stck.	kg
Auxiliary switch blocks for mounting at one side ①					
Screw connection					
CA 6-11K	GJL 120 1317 R 0001	K6... and KC6...		10	0.030
CA 6-11E	GJL 120 1317 R 0002	B6(7)-40-00 and BC6(7)-40-00		10	0.030
CA 6-11M	GJL 120 1317 R 0003	B6(7)-30-10 and BC6(7)-30-10		10	0.030
CA 6-11N	GJL 120 1317 R 0004	B6(7)-30-01 and BC6(7)-30-01		10	0.030
Flat pin connection					
CA 6-11K-F	GJL 120 1318 R 0001	K6...F and KC6...F		10	0.030
CA 6-11E-F	GJL 120 1318 R 0002	B6(7)-40-00-F and BC6(7)-40-00-F		10	0.030
CA 6-11M-F	GJL 120 1318 R 0003	B6(7)-30-10-F and BC6(7)-30-10-F		10	0.030
CA 6-11N-F	GJL 120 1318 R 0004	B6(7)-30-01-F and BC6(7)-30-01-F		10	0.030
Soldering connection					
CA 6-11K-P	GJL 120 1319 R 0001	K6...P and KC6...P		10	0.030
CA 6-11E-P	GJL 120 1319 R 0002	B6(7)-40-00-P and BC6(7)-40-00-P		10	0.030
CA 6-11M-P	GJL 120 1319 R 0003	B6(7)-30-10-P and BC6(7)-30-10-P		10	0.030
CA 6-11N-P	GJL 120 1319 R 0004	B6(7)-30-01-P and BC6(7)-30-01-P		10	0.030
Auxiliary switch blocks for mounting at front ① Screw connection					
CAF 6- 11K	GJL 120 1330 R 0001	K 6 and KC 6		10	0.035
CAF 6- 20K	GJL 120 1330 R 0005	K 6 and KC 6		10	0.035
CAF 6- 02K	GJL 120 1330 R 0009	K 6 and KC 6		10	0.035
CAF 6- 11E	GJL 120 1330 R 0002	B(C)6-, B(C)7-40-00, VB(C)...(A)		10	0.035
CAF 6- 20E	GJL 120 1330 R 0006	B(C)6-, B(C)7-40-00, VB(C)...(A)		10	0.035
CAF 6- 02E	GJL 120 1330 R 0010	B(C)6-, B(C)7-40-00, VB(C)...(A)		10	0.035
CAF 6- 11M	GJL 120 1330 R 0003	B(C)6-, B(C)7-30-10, VB(C)...(A)		10	0.035
CAF 6- 20M	GJL 120 1330 R 0007	B(C)6-, B(C)7-30-10, VB(C)...(A)		10	0.035
CAF 6- 02M	GJL 120 1330 R 0011	B(C)6-, B(C)7-30-10, VB(C)...(A)		10	0.035
CAF 6- 11N	GJL 120 1330 R 0004	B(C)6-, B(C)7-30-01, VB(C)...(A)		10	0.035
CAF 6- 20N	GJL 120 1330 R 0008	B(C)6-, B(C)7-30-01, VB(C)...(A)		10	0.035
CAF 6- 02N	GJL 120 1330 R 0012	B(C)6-, B(C)7-30-01, VB(C)...(A)		10	0.035
Soldering receptacle ($I_{th} \leq 8$ A)					
LB 6	GJL 120 1902 R 0001	For mini contactors B, BC, K, KC		10	0.014
LB 6-CA	GJL 120 1903 R 0001	For 2-pole auxiliary switch blocks		10	0.006
Plunger					
BN 6	GJL 120 1904 R 0001	For manual operation		50	0.060
Identification marker					
BA 50	FPTN 472 625 R 0001	50 clip-on label carriers 50 transparent covers 60 non-adhesive labels ③ 75 self-adhesive labels ③ (③ on sheet)		1 bag	0.100
Varistor-type surge suppressors for protective circuit of the DC contactors BC 6, BC 7 and KC 6					
<i>Note:</i> Mini contactors for AC operation have an integrated protective circuit.					
RV-BC6/60	GHV 250 1902 R 0002	24–60 V. with cable lug		10	0.004
RV-BC6-F/60	GHV 250 1902 R 0003	24–60 V. flat pin, 2.8 mm		10	0.004
RV-BC6/250	GHV 250 1903 R 0002	50–250 V. with cable lug		10	0.004
RV-BC6-F/250	GHV 250 1903 R 0003	50–250 V. flat pin, 2.8 mm		10	0.004
RV-BC6/380	GHV 250 1904 R 0002	380 V. with cable lug		10	0.004
RV-BC6-F/380	GHV 250 1904 R 0003	380 V. flat pin, 2.8 mm		10	0.004
Cover cap, transparent, sealable, enclosure IP 20					
LT 6- B	GJL 120 1906 R 0001	for contactors B, BC, K, KC 6 with screw connection		10	0.001
Reversing connecting link					
BSM 6-30	GJL 120 1908 R 0001	for compact reversing contactors, VB.., VBC.. with screw connection, cross-section 1.8 mm ²		10	0.010
Parallel connecting link					
LP 6	GJL 120 1907 R 0001	for contactors B, BC, mit Schraubanschluß, 1 mm thick		100	0.001

① Auxiliary switches CA 6 and CAF 6 may not be fitted simultaneously.

Compact reversing contactors

Mini motor contactors, Mini contactor relays

Technical data to IEC 947-4-1, IEC 947-5-1

Utilisation category AC-1/AC-3
Contact member service life curves
B 6, BC 6, B 6S

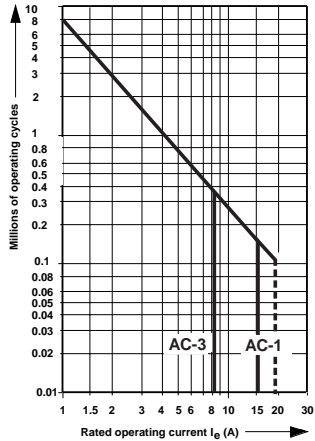

Utilisation category AC-4
Switching a 3-phase squirrel-cage induction motor and switching off the starting current.
Switch-off current I_c at AC-4 corresponds to 6 times the motor's rated operating current.

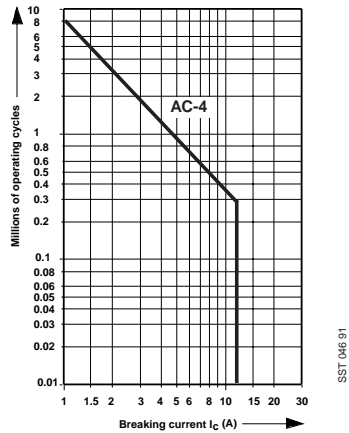

Utilisation category AC-15
Contact member service life curves
K 6, KC 6, CA 6, CAF 6

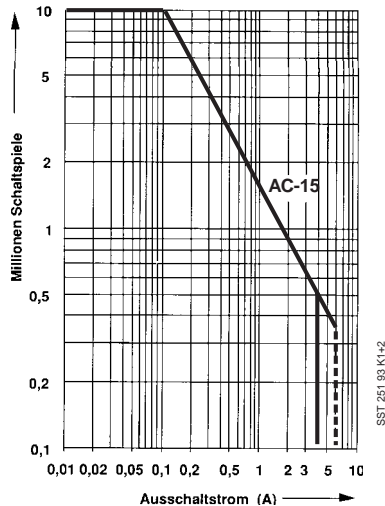

General data

Rated insulation voltage U_i	V	690
Permissible ambient temperature		
Contactor without overload relay	°C	- 25 ... + 55
Contactor with overload relay	°C	- 25 ... + 50
Storage temperature	°C	- 40 ... + 80
Climatic resistance	to DIN 50 017 to UTE C 63-100	Resistant to changeable climates KFW, 30 cycles Version I
Mounting position		any

Main contacts

Mechanical service life	10 million operations			
Electrical service life	see curves			
Max. switching frequency AC-1	ops./h	300		
DC-1, DC-3, DC-5, AC-2, AC-3, AC-15, DC-13	ops./h	600		
Rated operating voltage U_e	V AC	12 to 690		
Rated operating current I_e/AC-1, AC-3 and max. motor output / AC-3 at U_e		AC-1 / I_e A	AC-2, AC-3	
		55 °C	40 °C	I_e A
	220/240 V	16	20	9
	380/440 V	16	20	9/8
	500 V	12	12	5.5
				P kW
				4.0
				3.0

Switching times		B 6	B C6	K 6	K C6
Closing delay	NO	14 to 26		14 to 26	
Opening delay		16 to 40	4 to 10	16 to 40	4 to 10
Closing delay	NC	18 to 42		18 to 42	
Opening delay		6 to 12	6 to 12	6 to 12	6 to 12
		14 to 26		14 to 26	

Shock resistance with normal installation position	Semi-sinusoidal shock, 10 ms: with no change in contact state				
Shock resistance	A	B1	B2	C1	C2
Contactors switched off	20 g	20 g	20 g	20 g	20 g
Contactors switched on	10 g	20 g	20 g	20 g	20 g

Power loss per pole:	2 W at 20 A
Back-up fuse, Type gL, Type 1, Type 2	20 A, 20 A

Auxiliary contacts: integrated, CA 6, CAF 6, K 6, KC 6, K 6S

Rated operating voltage U_e	V DC	12 to 240
	V AC	12 to 500
Conventional thermal continuous current I_{th}	A	6
Back-up fuse, Type gG	A	10
Rated operating current I_e / AC-15		
at U_e	24-240 V	A
	380/440 V	A
	500 V	A
		4
		3
		2
Rated operating current I_e / DC -13		
at U_e	24 V	A
	60 V	A
	110 V	A
	220/240 V	A
		1.5
		0.5
		0.4
		0.04
Min. making/breaking capacity of the auxiliary contacts	≥ 17 V and ≥ 5 mA	

Solenoid coils

Rated power	closing / holding			
Basic contactors				
B 6 / K 6, VB 6	AC	VA	3.5	
BC 6 / KC 6, VBC 6	DC	W	3.5	
Interface contactors				
BC 6 / KC 6-1.4	DC 24 V	W	1.4	
BC 6 / KC 6-2.4	DC 17 ... 32 V	W	2.4	
Mini contactor for connection to PLCs, mini contactor relay for connection to PLCs			cold	warm
			I mA	P W
B 6 NO-1.7, K 6S-1.7	DC 24 V	W	77	1.75
B 6 NO-2.8, K 6S-2.8	DC 17 ... 32 V	W	125	2.80
			I mA	P W
			60	1.35
			94	2.10
Coil voltage range	0.85 ... 1.1x U_e			

Switching DC, see overleaf

Mini motor contactors

Compact reversing contactors

Technical data to IEC 947-4-1

Utilisation category AC-1/AC-3
Contact member service life curves
B 7, BC 7, B 7S

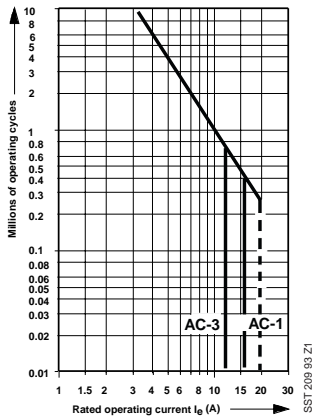

Utilisation category AC-4
Switching a 3-phase squirrel-cage induction motor and switching off the starting current.
Switch-off current I_c at AC-4 corresponds to 6 times the motor's rated operating current

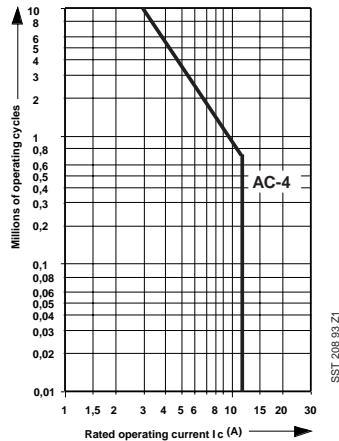

Utilisation category AC-15
Contact member service life curves
K 6, KC 6, CA 6, CAF 6

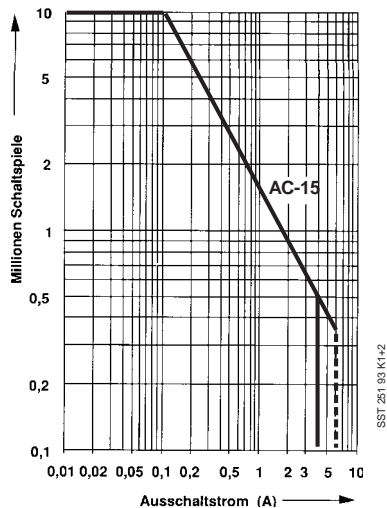

General data

Rated insulation voltage U_i	V	690
Permissible ambient temperature		
Contactor without overload relay	°C	-25 ... +55
Contactor with overload relay	°C	-25 ... +50
Storage temperature	°C	-40 ... +80
Climatic resistance	to DIN 50 017 to UTE C 63-100	Resistant to changeable climates KFW, 30 cycles Version 1
Mounting position		any

Main contacts

Mechanical service life	10 million operations	
Electrical service life	see curves	
Max. switching frequency AC-1	ops./h	300
DC-1, DC-3, DC-5, AC-2, AC-3, AC-15, DC-13	ops./h	600
Rated operating voltage U_e	V AC	12 to 690
Rated operating current I_e / AC-1, AC-3 and motor output / AC-3		
at U_e		
	AC-1 / I_e A	AC-2, AC-3
	55 °C 40 °C	I_e A P kW
	16 20	12/11 3
	16 20	12/11 5.5
	12 12	7 4

Switching times

			B 7	BC 7
Closing delay	NO	ms	14 to 26	
Opening delay		ms	16 to 40	4 to 10
Closing delay	NC	ms	18 to 42	6 to 12
Opening delay		ms	14 to 26	

Shock resistance with normal installation position

	Semi-sinusoidal shock, 10 ms, with no change in contact state					
	Shock direction	A	B1	B2	C1	C2
	Contactors switched off	20 g	20 g	20 g	20 g	20 g
	Contactors switched on	10 g	20 g	20 g	20 g	20 g

Power loss per pole:

	2 W at 20 A	
Back-up fuse assignment type	Type 1	25 A
Type gG (gL)	Type 2	20 A

Auxiliary contacts: integrated

Minimum making/breaking	≥ 17 V ≥ 5 mA
--------------------------------	-------------------------

Solenoid coils

Rated power	Closing / holding			
Basic contactors				
B 7 / VB 7	AC	VA	3.5	
BC 7 / VBC 7	DC	W	3.5	
Interface contactors				
BC 7-1.4	DC 24 V	W	1.4	
BC 7-2.4	DC 17 ... 32 V	W	2.4	
Mini contactor for connection to PLCs			cold	worm
			I (mA)	P (W)
B 7 NO-1.7	DC	24 V	77	1.70
B 7 NO-2.8	DC	17 ... 32 V	125	2.80
			60	1.35
			94	2.10

Coil voltage range

	0.85...1.1x U_e
--	-------------------

Utilisation categories for B 6 and B 7

Utilisation category		DC-1	DC-3	DC-5
		L/R < 1 ms	L/R < 2 ms	L/R < 7.5 ms
	24 V A 48 V A 60 V A 110 V A 220 V A	16.0 16.0 16.0 7.0 0.8	16.0 8.0 4.0 1.5 0.25	16.0 2.0 1.25 0.4 0.20
	24 V A 48 V A 60 V A 110 V A 220 V A	16.0 16.0 16.0 16.0 5.0	16.0 16.0 15.0 7.0 1.5	16.0 16.0 12.0 2.0 0.5
	24 V A 48 V A 60 V A 110 V A 220 V A	16.0 16.0 16.0 16.0 14.0	16.0 16.0 16.0 15.0 4.0	16.0 16.0 16.0 8.0 2.0

Mini motor contactors B 6, B 7 / BC 6, BC 7

Compact reversing contactors VB 6(7) / VBC 6(7)

Contact member service life, utilisation categories

Contact member service life for utilisation categories DC-1, DC-3, DC-5

The following curves show the contact member service life for utilisation categories DC-1, DC-3 and DC-5 for 3 poles in series. If only one current path is used, the service life read off for the related breaking capacity must be multiplied by **0.33**, and, if there are 2 current paths, it must be multiplied by **0.66**.

The time constants L/R (ms) which differ for the individual utilisation categories have been allowed for on the curves.

- A = 3 poles in series DC-1
- B = 3 poles in series DC-3
- C = 3 poles in series DC-5

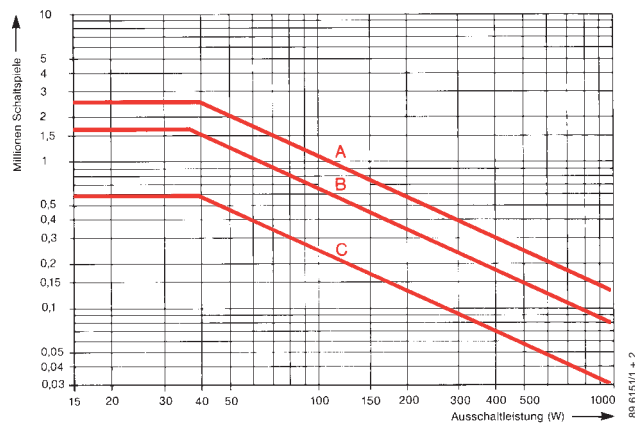

Mini motor contactors B 6, B 7 / BC 6, BC 7

Compact reversing contactors VB 6 (7) / VBC 6 (7)

Switching lamp loads

Switching lamp loads

The following table shows the number of lamps which can be connected per circuit at 230 V/50 Hz. Please note the following:

If the specified capacitor load is exceeded, this may result in admissibly high peak inrush currents. Other factors which influence the magnitude of peak inrush currents are as follows:

- Length and cross-section of installed supply cables
- Type of electronic ballast units
- Lamp make

The following lamp load table thus contains non-binding guideline values.

Lamp type	Lamp data		Permissible number of lamps per circuit (230 V, 50 Hz) in the case of contactor type B6, B7, BC6, BC7	Capacitor load in μF
	Watt	I_n A		
Incandescent lamps	60	0.26	20	
	100	0.43	12	
	200	0.87	6	
	300	1.30	4	
	500	2.17	2	
	1000	4.35	1	
Fluorescent lamps	p.f. uncorrected and series p.f. correction			
	15	0.33	25	
	20	0.37	23	
	40	0.43	20	
	58	0.67	16	
	65	0.67	12	
	115	1.5	5	
	140	1.5	5	
	Lead-lag circuit			
	2 x 20	2 x 0.13	2 x 26	Lamp pairs
2 x 40	2 x 0.22	2 x 20		
2 x 58	2 x 0.32	2 x 16		
2 x 65	2 x 0.34	2 x 12		
2 x 115	2 x 0.65	2 x 5		
2 x 140	2 x 0.75	2 x 5		
Parallel p.f. correction				
15	0.11	7	4.5	
20	0.13	6	4.5	
40	0.22	7	4.5	
58	0.32	5	7	
65	0.34	4	7	
115	0.65	1	18	
140	0.75	1	18	
High-pressure mercury-vapour lamps e.g. HQL, HPL	p.f. uncorrected			
	50	0.61	10	
	80	0.8	7	
	125	1.15	5	
	250	2.15	3	
	400	3.25	2	
	700	5.40	1	
	Parallel p.f. correction			
	50	0.28	4	7
	80	0.41	3	8
	125	0.65	2	10
	250	1.22	1	18
	400	1.95	1	25
700	3.45	–	45	
1000	4.8	–	60	
Lamps with electronic ballast units	1 x 18	–	17	
	2 x 18	–	8	
	1 x 36	–	11	
	2 x 36	–	6	
	1 x 56	–	11	
	2 x 58	–	6	

Lamp type	Lamp data		Permissible number of lamps per circuit (230 V, 50 Hz) in the case of contactor type B6, B7, BC6, BC7	Capacitor load in μF
	Watt	I_n A		
Metal-halogen lamps e.g. HQI, HPI	p.f. uncorrected			
	35	0.53	10	
	70	1	5	
	150	1.8	3	
	250	3	2	
	400	3.5	1	
	Parallel p.f. correction			
	35	0.25	6	6
	70	0.45	3	12
	150	0.75	1	20
250	1.5	1	33	
400	2.5	1	35	
Low-pressure sodium-vapour lamps	p.f. uncorrected			
	35	1.5	4	
	55	1.5	4	
	90	2.4	2	
	135	3.5	2	
	150	3.3	2	
	180	3.3	2	
	200	2.3	2	
	Parallel p.f. correction			
	35	0.31	–	20
55	0.42	–	20	
90	0.63	–	30	
135	0.94	–	45	
150	1.0	–	40	
180	1.16	–	40	
200	1.32	–	25	
High-pressure sodium-vapour lamps	p.f. uncorrected			
	150	1.8	3	
	250	3.0	2	
	330	3.7	2	
	400	4.7	1	
	Parallel p.f. correction			
	150	0.83	–	20
	250	1.5	–	33
	330	2.0	–	40
	400	2.4	–	48
1000	6.3	–	106	
Transformers for halogen low-volt lamps	Transformers for	Permissible number of transformers per circuit (230 V, 50 Hz) in the case of contactor type B6, B7, BC6, BC7		
	Watt			
	20	40		
	50	20		
	75	13		
	100	10		
	150	7		
	200	5		
	300	3		

Mini motor contactors, mini contactor relays

Thermal overload relay, Accessories, Approvals

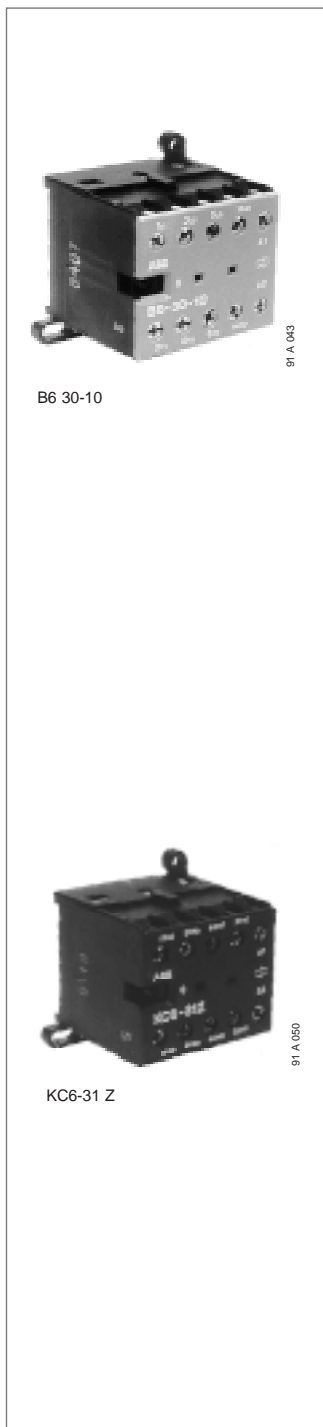

B6 30-10

KC6-31 Z

The following equipment has been approved or approval has been requested in those countries and classification societies where approval is mandatory. For some countries, special versions of equipment are available. When a supplier of a control unit incorporates approved equipment, this does not exempt him from his obligation to implement the overall installation in accordance with the legal local requirements of the country involved.

Approvals

Test marks

Abbreviation

Validity

SEV	DEMKO	NEMKO	SEMKO	EL	CS	USA	USA	GL
Switzerland	Denmark	Norway	Sweden	Finland	Canada			Germany

Mini motor contactors

B6./ B7..	■	■	■	■	■	■	■	■	■
B6/B7..-F	■	■	■	■	■	■	■	■	■
B6/B7..-P	■	■	■	■	■	■	■	■	■
BC6/BC 7..	■	■	■	■	■	■	■	■	■
BC6/BC 7..-F	■	■	■	■	■	■	■	■	■
BC6/BC7..-P	■	■	■	■	■	■	■	■	■
BC6/BC7..-1.4	■	■	■	■	■	■	■	■	■
BC6/BC7..-F-1.4	■	■	■	■	■	■	■	■	■
BC6/BC7..-P-1.4	■	■	■	■	■	■	■	■	■
BC6/BC7..-2.4	■	■	■	■	■	■	■	■	■
BC6/BC7..-F-2.4	■	■	■	■	■	■	■	■	■
BC6/BC7..-P-2.4	■	■	■	■	■	■	■	■	■
B 6 S/B7 S	■	■	■	■	■	■	■	■	■

Compact reversing contactors

VB6/VB7..	■	■	■	■	■	■	■	■	■
VBC 6/VBC7	■	■	■	■	■	■	■	■	■

Thermal overload relay

T6 DU	■	■	■	■	■	■	■	■	■
-------	---	---	---	---	---	---	---	---	---

Mini contactor relays

K6..	■	■	■	■	■	■	■	■	■
K6..-F	■	■	■	■	■	■	■	■	■
K6..-P	■	■	■	■	■	■	■	■	■
KC6..	■	■	■	■	■	■	■	■	■
KC6..-F	■	■	■	■	■	■	■	■	■
KC6..-P	■	■	■	■	■	■	■	■	■
KC6..-1.4	■	■	■	■	■	■	■	■	■
KC6..-F-1.4	■	■	■	■	■	■	■	■	■
KC6..-P-1.4	■	■	■	■	■	■	■	■	■
KC6..-2.4	■	■	■	■	■	■	■	■	■
KC6..-F-2.4	■	■	■	■	■	■	■	■	■
KC6..-P-2.4	■	■	■	■	■	■	■	■	■

Accessories

CA6-11..	■	■	■	■	■	■	■	■	■
CAF6..	■	■	■	■	■	■	■	■	■
LB6	■	■	■	■	■	■	■	■	■
LB6-CA	■	■	■	■	■	■	■	■	■

■ Normal version approved; rating plates bear the test mark if mandatory.

■ Submitted for approval

Motor rating and rated operating currents in accordance with CSA and UL for contactors (B(C)6 and B(C) 7, in addition to contactor relays K(C)6.

In the case of CSA and UL, the contactors are approved both for "Motor rating 3-phase" and for "AMP rating". For this reason, the permissible ratings for contactors are approved either for "hp" or "Amp rating", with an assigned rated current

Motor rating 3-phase for contactors B(C)6:

Rated operating voltage	$U_e \sim$ (V)	110/120 V	220/240 V	440/480 V	540/600 V
Motor output 3-phase	P (hp)	1	2	1	1
	I_e (A)	7.2	6.8	1.8	1.4
Motor output Single-phase	P (hp)	1	2	—	—
	I_e (A)	16	12	—	—

Amp-rating: – 12 A-300 V, AC for the main contacts of contactors B(C)6

respectively. The approved values for the individual contactors and contactor relays are given in the table below. The determining factor is the data indicated on the units as shown on the following table

Motor rating-3-phase for contactors B(C)7 :

Rated operating voltage	$U_e \sim$ (V)	110/120 V	220/240 V	440/480 V	540/600 V
Motor output 3-phase	P (hp)	1	3	5	5
	I_e (A)	7.2	9.6	7.6	6.1
Motor output Single-phase	P (hp)	0.5	1	2	2
	I_e (A)	9.8	16	6	4.8

Amp-rating: – 12 A-600 V, AC for the main contacts of contactors B(C)7

5 A-600 V, AC pilot duty A 600 for incorporated auxiliary contacts B(C)6, K(C)6 and B(C)7, in addition to attachable auxiliary switch blocks CA6. Values for 220 ... 208 V = (220 ... 240 V) x 1.15

Mini contactors and mini contactor relays

Terminal designation

and location of the connection terminals

Location of the connection terminals and terminal designation

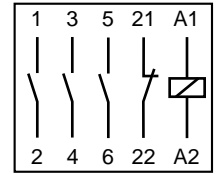
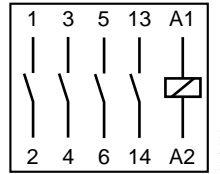
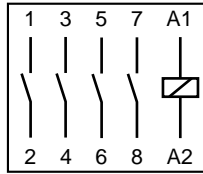

Mini contactors

B 6(7)-40-00 ...
BC 6(7)-40-00 ...

B 6(7)-30-10 ...
BC 6(7)-30-10 ...

B 6(7)-30-01 ...
BC 6(7)-30-01 ...

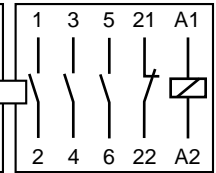
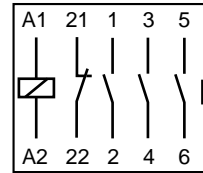
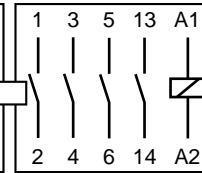
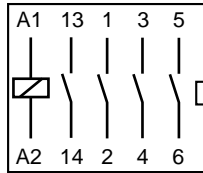

Compact reversing contactors

VB 6(7)-30-10 ...
VBC 6(7)-30-10 ...

VB 6(7)-30-01 ...
VBC 6(7)-30-01 ...

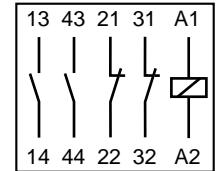
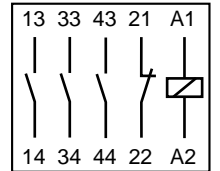
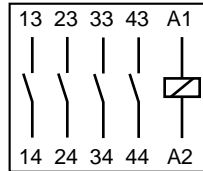

Mini contactor relays

K 6-40 E ...
KC 6-40 E ...

K 6-31 Z ...
KC 6-31 Z ...

K 6-22 Z ...
KC 6-22 Z ...

Auxiliary switches CA 6/CAF 6 ①

For extending the mini contactors B 6, B 7, BC 6, BC 7, K 6 and KC 6 with auxiliary contacts

Except: Contactors with coils < 3.5 W

Auxiliary switches CA 6..., attachable at side

Cannot be attached on compact reversing contactors VB 6 (7), VBC 6(7), VB 6A (7) or VBC 6A (7).

Connection type: Screw connection
Flat pin connection
Soldering connection

Auxiliary switches CAF 6, (also in the case of reversing contactors) can be screwed on at the front

Connection type: Screw connection

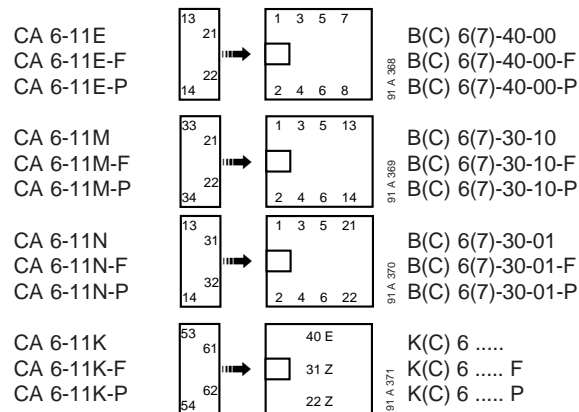

Schütztypen

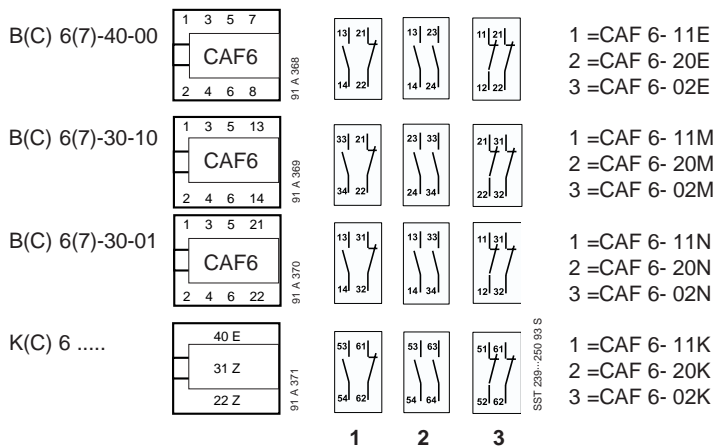

① Only one CA 6 or one CAF 6 auxiliary switch can be attached to a contactor in each case

Mini contactors

Accessories

Dimension diagrams

Dimensions in mm
Subject to modification

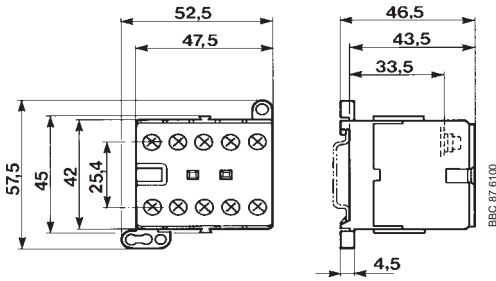

B 6(7)..., BC 6(7)..., K 6..., K C6...,
for screw connection

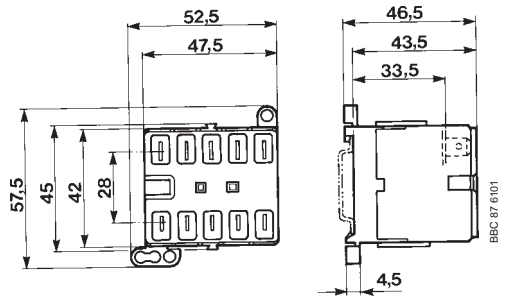

B 6(7)..., BC 6(7)..., K 6..., KC 6...,
for flat pin connection

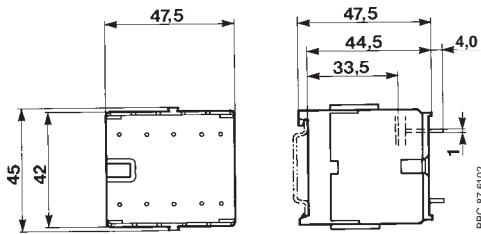

B 6(7)..., BC 6(7)..., KC 6..., KC 6...,
with soldering pins

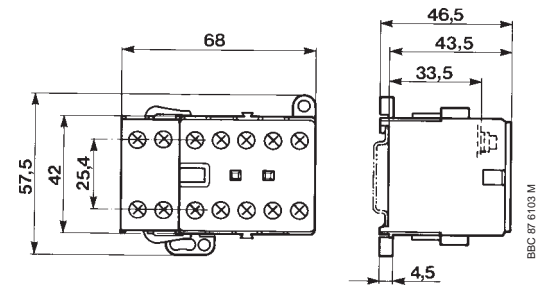

B 6(7)..., B C6(7)..., K 6..., KC 6...,
with auxiliary switch block CA6

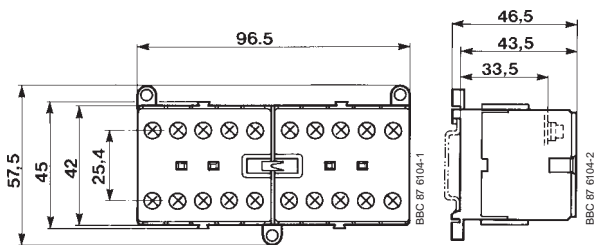

Compact reversing contactor VB(C) 6(7)
with screw connection

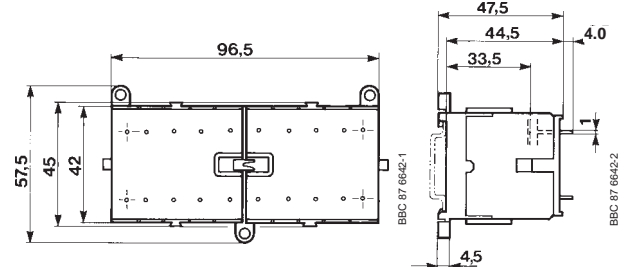

Compact reversing contactor VB(C) 6(7)
with soldering pins

Drilling plans for mini contactors

For screw mounting M4

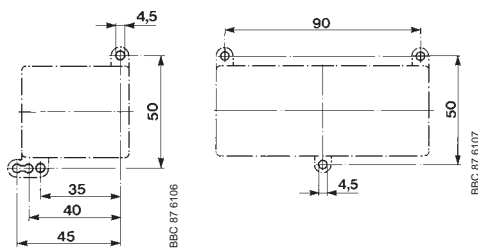

B 6(7)..., BC 6(7)...,
K 6..., KC 6...

VB 6(7), VBC6(7)
VB 6A(7A), VBC 6A(7A)

For PC board

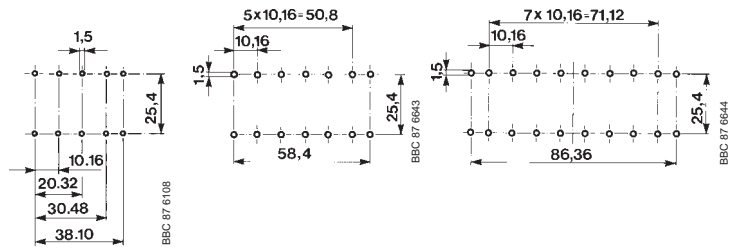

Basic devices
4-pole

Basic devices with
auxiliary switch block

Compact
reversing contactor

Mini contactors

Accessories

Dimension diagrams

Dimensions in mm
Subject to modification

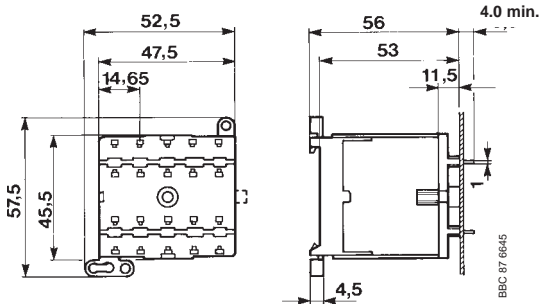

B 6 (7) - F mit
LB 6

Auxiliary switch blocks

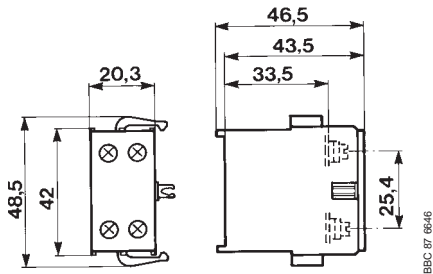

CA 6

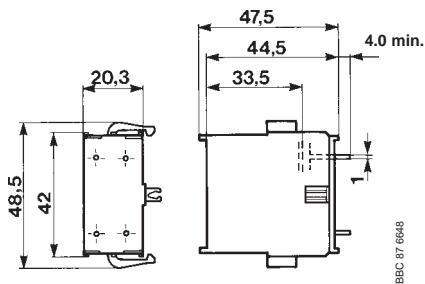

CA 6- P

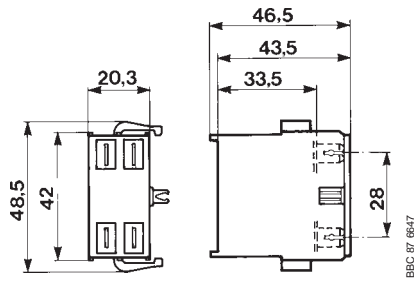

CA 6- F

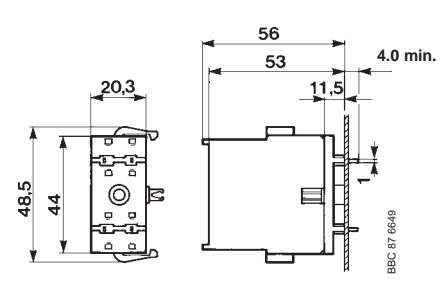

CA 6 with LB 6- CA

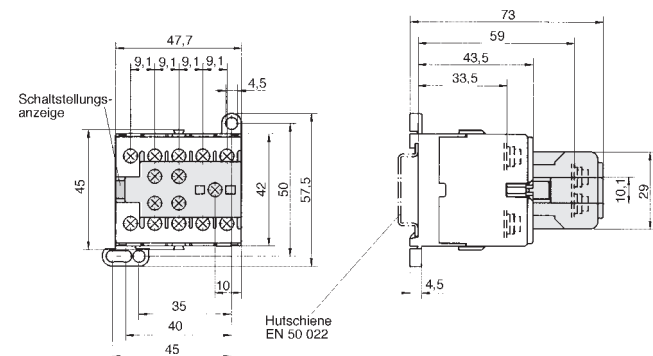

S5T 210 94 M

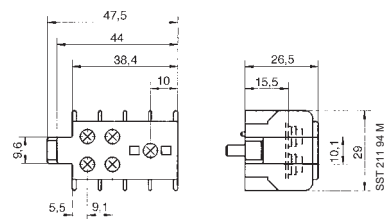

CAF 6

B(C) 6, B(C) 7, K(C) 6
with screwed-on auxiliary switch block CAF 6

Thermal overload relay T 7 DU

for mini contactors

Technical data, ordering details



SST002 98

Thermal overload relay
T 7 DU



1001 1001 000

Thermal overload relay
T 7 DU mounted onto
a mini contactor B 7-30-01

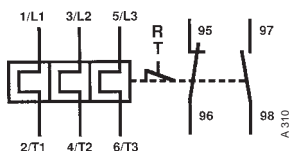

Type	Order code	Setting range A ... A	Max. fuse		Preis per piece	Pack. unit piece	Weight kg
			aM A	gL A			
Thermal overload relay T 7 DU for mini contactors B 6, BC 6, B 6S, BC 6, VB 6, VBC 6, B 7, BC 7, B7S, BC 7, VB 7, VBC 7							
T 7 DU 0.16	1SAZ 111 301 R 0001	0.10 ... 0.16		0.5		1	0.070
T 7 DU 0.24	1SAZ 111 301 R 0002	0.16 ... 0.24		1,0		1	0.070
T 7 DU 0.4	1SAZ 111 301 R 0003	0.24 ... 0.40		2,0		1	0.070
T 7 DU 0.6	1SAZ 111 301 R 0004	0.40 ... 0.60		2,0		1	0.070
T 7 DU 1.0	1SAZ 111 301 R 0005	0.60 ... 1.00		4,0		1	0.070
T 7 DU 1.6	1SAZ 111 301 R 0006	1.00 ... 1.60		6,0		1	0.070
T 7 DU 2.4	1SAZ 111 301 R 0007	1.60 ... 2.40		6,0		1	0.070
T 7 DU 4.0	1SAZ 111 301 R 0008	2.40 ... 4.00		10,0		1	0.070
T 7 DU 6.0	1SAZ 111 301 R 0009	4.00 ... 6.00		10,0		1	0.070
T 7 DU 9.0	1SAZ 111 301 R 0010	6.00 ... 9.00		10,0		1	0.070
T 7 DU 12.0	1SAZ 111 301 R 0011	9.00 ... 12.00		20,0		1	0.070

T7 DU is into normal Version for EEx e suitableTable:
Tripping times of T7 DU at multiple of setting current on request.
Technical data see page 18.

Dimension (in mm)
B6 / B7 with mounted T7 DU see page 16.

Motor protection selection of protection device see Page 28.
Technical data for T/ DU see page 36, 37, 38, 40.
Description for T/ DU see page 35.
Approvals and crtificates see page 44.

The tripping characteristic is the value at 20°C ambient temperature from cold state. The tripping time is dependent on the operating current. By operating in a warm state the tripping time of the overload relay approximately is reduced by 1/4 of the relevant value in cold state.

Thermal overload relay T 7 DU

for mini contactors

Technical data, ordering details

Technical data

Rated insulation voltage	U_i	690 V
Permissible ambient temperature	°C	-25 ... +50 open temperature-compensated
Storage temperature	°C	-40 ... +70
Mounting position		±30° referred to vertical mounting position not horizontal, not upside down, 5 mm lateral clearance for side-by-side mounting
Switching frequency with avoidance of premature tripping	max. ops./h	15
- 40 % relative duty	max. ops./h	60 (if 6 x I_n starting time - 1s)

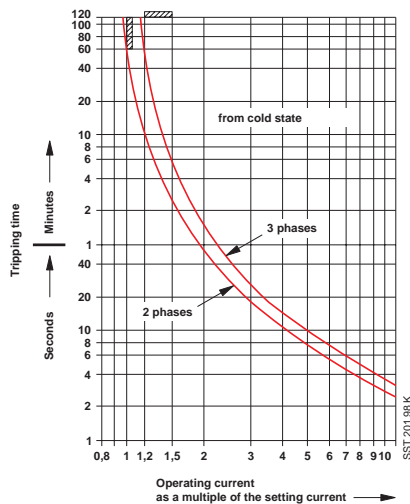

Load rating of auxiliary switches

Type	T 7 DU		
	NC 95-96	NO 97-98	
Rated operating voltage U_e	V	500	500
Thermal continuous current	A	6	6
Rated operating voltage I_e			
at AC-15 220 to 240 V	A	1.5	1.5
at AC-15 380 to 415 V	A	0.7	0.5
at AC-15 to 500 V	A	0.5	0.3
In the case of DC-15 220 V	A	0.2	0.2
Short-circuit protection	gL A	4	4
STOTZ automatic circuit-breaker:			
S 271	A		
S 281	A		

Time-current curves (mean values), for thermal overload relay T 7 DU, 0.1 ... 12 A.

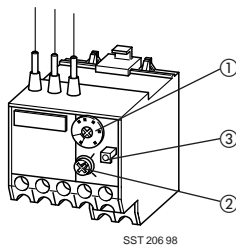

Setting options

- ① **Setting knob** for motor rated current
- ② **Reset:** Manual "manual reset"
Position A: Auto "without manual reset"
Position H: Reset off
- ③ **Test knob**

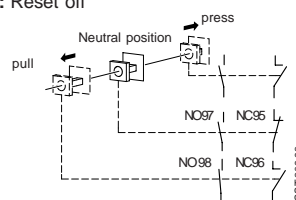

Motor starters in insulating-material housings DRB 6, DRB 7



DRB 6 / DRB 7

SST 065 95 R

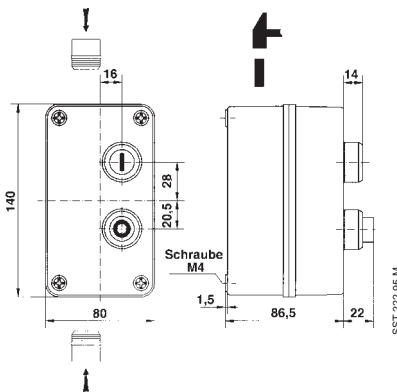

Dimension diagram DRB 6 / DRB 7

SST 222 95 M

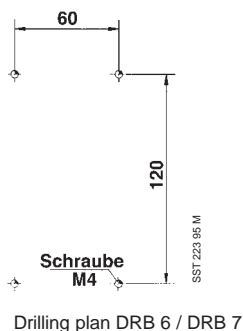

Drilling plan DRB 6 / DRB 7

The convincing features of the motor starters DRB 6 and DRB 7 are their power and efficiency with compact design. DRB 6 is capable of switching rated motor outputs of 4 kW AC3 and DRB 7 switches rated outputs up to 5.5 kW AC3. The devices are extremely low-noise.

The motor starters feature contactors of type of construction B 6 resp. B 7 with universal coils. The insulating-material housings comply with enclosure IP 65. The starters are available in two versions: with or without integrated thermal overload relay T 7 DU.

Ordering details

Type	Control voltage 40 to 450 Hz.	Order code	Max. back-up fuse, Type 2		Price	Weight/ piece kg
			aM A	gl A		

Motor starter with thermal overload relay T 7 DU

DRB 6	1.0 A	220 -240 V AC	GJK 127 4156 R 5689	2	4	0.670
DRB 6	1.6 A	220 -240 V AC	GJK 127 4156 R 5691	2	4	0.670
DRB 6	2.4 A	220 -240 V AC	GJK 127 4156 R 5693	4	6	0.670
DRB 6	4.0 A	220 -240 V AC	GJK 127 4156 R 5694	4	6	0.670
DRB 6	6.0 A	220 -240 V AC	GJK 127 4156 R 5696	10	16	0.670
DRB 6	9.0 A	220 -240 V AC	GJK 127 4156 R 5697	12	20	0.670

Motor starter without thermal overload relay

DRB 6	220-240 V AC	GJK 127 4156 R 5601			0.580
DRB 7	220 -240 V AC	GJK 137 4156 R 5601			0.580

Technical data

General data:

Motor starters DRB 6 and DRB 7 feature thermal overload relays T 7 DU and pushbuttons "ON"- "OFF/RESET" and are wired in accordance with the circuit diagram below. (Pushbuttons green for ON, red for OFF/RESET)

Motor output, AC-3:

DRB 6 380-415 V 4.0 kW **DRB 7** 380-415 V 5.5 kW

Application:

Starting 3-phase motors, 40-60 Hz AC3

Circuit diagram

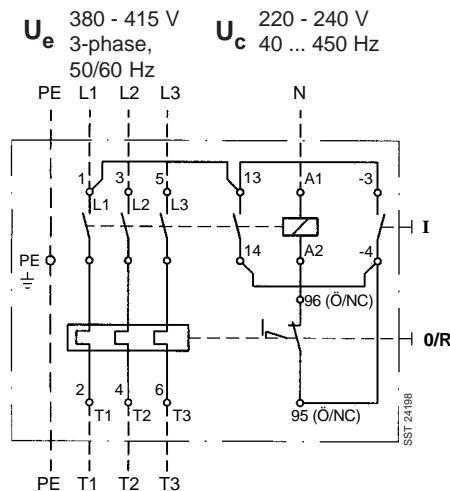

Star-delta contactor combinations

Type YKB 7-30

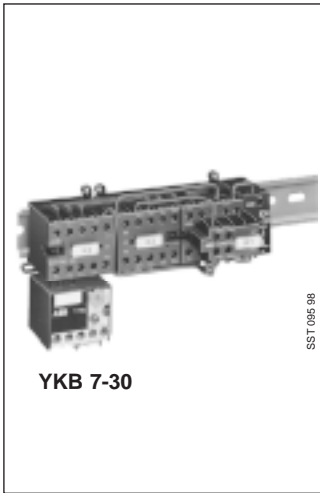

Star-delta contactor combination YKB 7-30 for switching motors up to 9 kW AC3 400/440 V.

The small, compact and extremely flat combination can be used primarily for applications in which space is at a premium or which involve a low installation depth owing to their compact dimensions of (HxWxD) 105 x 185 x 80.6 mm.

The star-delta contactor combination consists of a three mini contactors, one thermal overload relay

(set to rated motor current x 0.58) and a star-delta timer block with a setting range of 1.5 ... 30 s.

The YKB 7-30 is pre-wired ready for connection and is mounted on a top-hat rail to DIN EN 50 022, enclosure IP 00.

An incorporated mechanical interlock which mutually interlocks the star contactor and delta contactor ensures high operational reliability.

Ordering details

Motor output P 400 V, AC 3 kW	Contactors N,Y,Δ	Thermal overload relay Setting range A	Order code Add the code No. <input type="checkbox"/> to the order code	Price	Weight/ piece kg	Pack. unit piece
4	B7, VB7	4.0 ... 6.0	GJK 131 389 <input type="checkbox"/> R 0096		0.760	1
5.5 ... 7.5	B7, VB7	6.0 ... 9.0	GJK 131 389 <input type="checkbox"/> R 0097		0.760	1
9	B7, VB7	9.0 ... 12.0	GJK 131 389 <input type="checkbox"/> R 0098		0.760	1

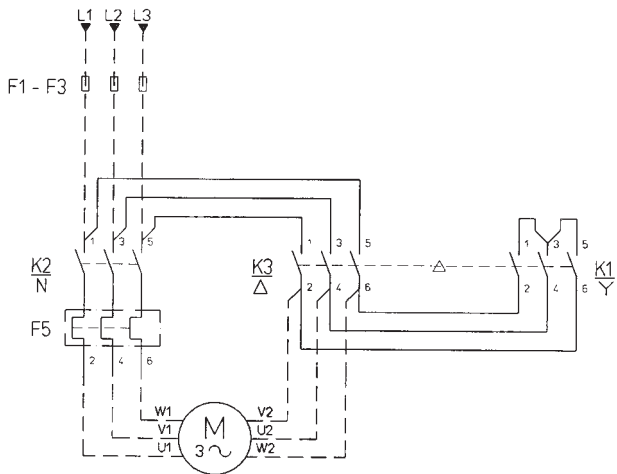

Main circuit for YKB 7-30

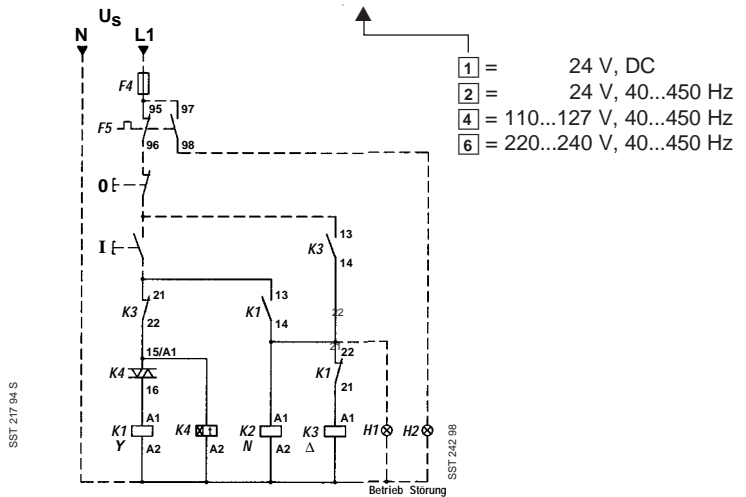

Control circuit for YKB 7-30

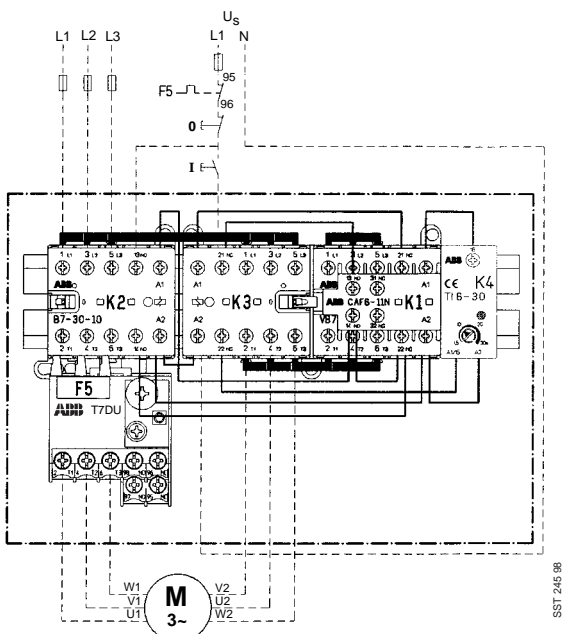

Wiring diagram for YKB 7-30

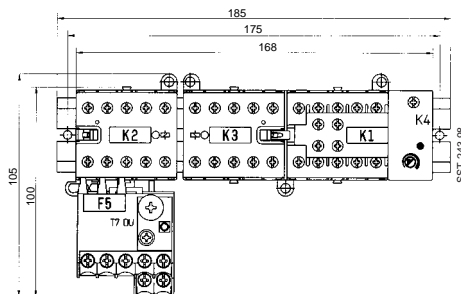

Dimension diagram for YKB 7-30

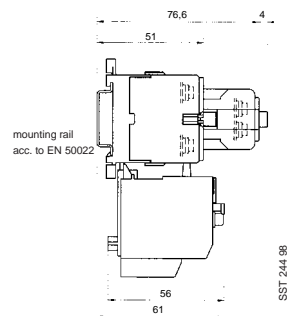



ABB STOTZ-KONTAKT GmbH
P.O.BOX 101680
D-69006 Heidelberg
Telephone ++49 62 21 / 701-00
Telefax ++49 62 21 / 701-1115
Internet <http://www.abb.de/sst>

Publication
no: 1SAC 1012 01 D0201
Printed in Germany (02/01)